

Glendale Arena

# 2006 State

## Team Scores

February 10-11

---

1.	CAMP VERDE	177.50
2.	MARICOPA	154.00
2. (tie)	WILLCOX	154.00
4.	MORENCI	151.00
5.	MOGOLLON	148.00
6.	SAN MANUEL	106.00
7.	BENSON	87.00
8.	JOSEPH CITY	64.00
9.	VALLEY CHRISTIAN	61.50
10.	PIMA	61.00
11.	BOURGADE	59.50
12.	RED MESA	57.00
13.	ANTELOPE	55.00
14.	THATCHER	53.50
15.	HAYDEN	52.50
16.	PHOENIX CHRISTIAN	45.00
17.	BISBEE	43.00
18.	SAN PASQUAL	40.00
19.	ST JOHNS	36.00
20.	MANY FARMS	29.00
21.	PRECISION	22.00
22.	BABOQUIVRI	18.00
22. (tie)	PINON	18.00
24.	CANYON STATE	17.00
25.	SAN CARLOS	13.00
25. (tie)	VALLEY UNION	13.00
27.	VALLEY SANDERS	10.00
28.	SUPERIOR	8.00
29.	YUMA CATHOLIC	6.00
30.	ROUGH ROCK	5.00
31.	PUSCH RIDGE	3.00
31. (tie)	ST AUGUSTINE	3.00
33.	SALT RIVER	0.00
33. (tie)	SHONTO	0.00

**Tourney Contact**00000  
e-mail:**Publisher****Preferred Educational Software**

9585 Woodgate Lane

Byron IL 61010

Phone: (888) 959-2016

e-mail: [cotterk@pes-sports.com](mailto:cotterk@pes-sports.com)

© 2001 - All rights reserved

# 2006 State Glendale Arena February 10-11

## Weight: 103

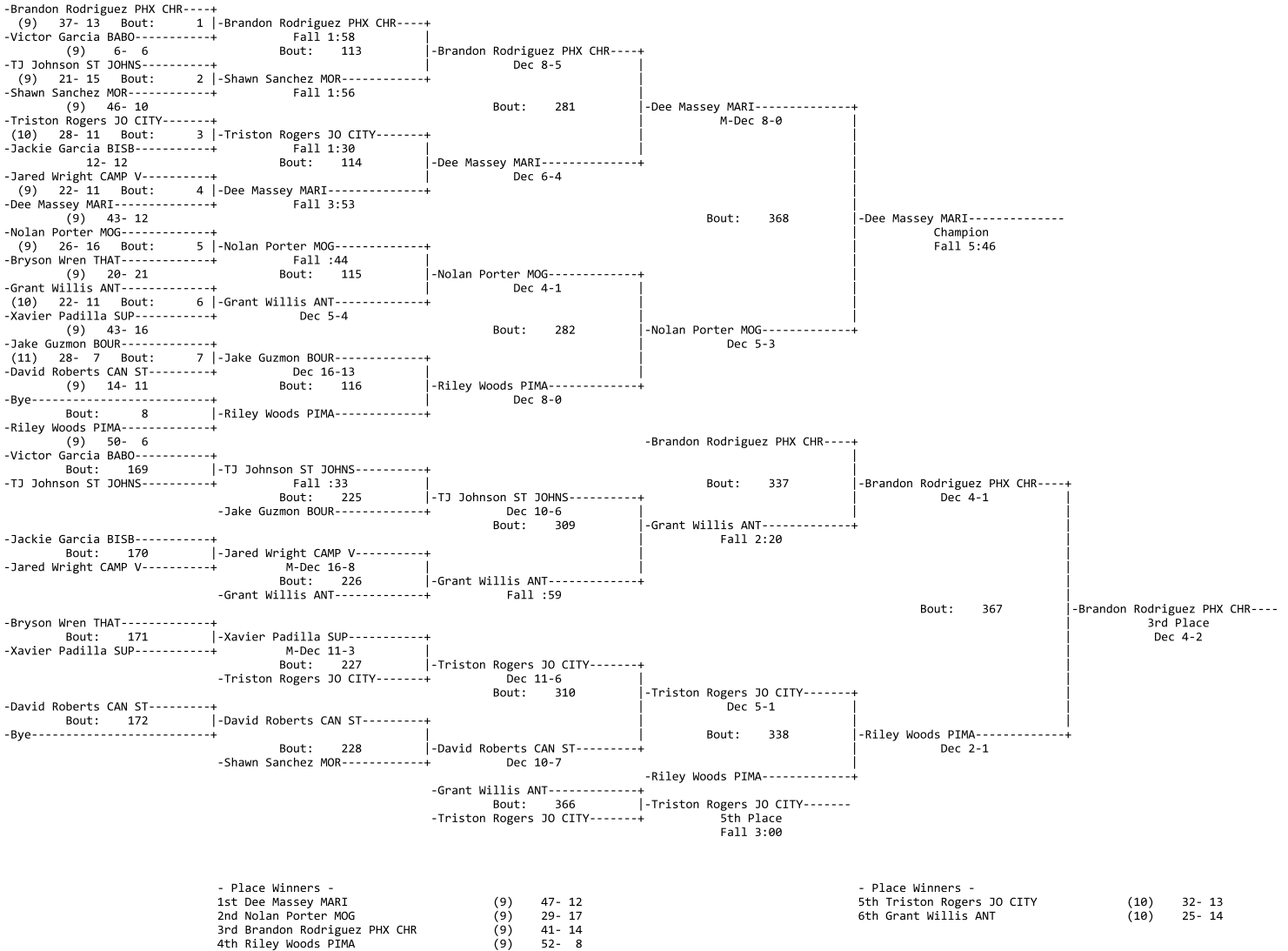

## Weight: 112

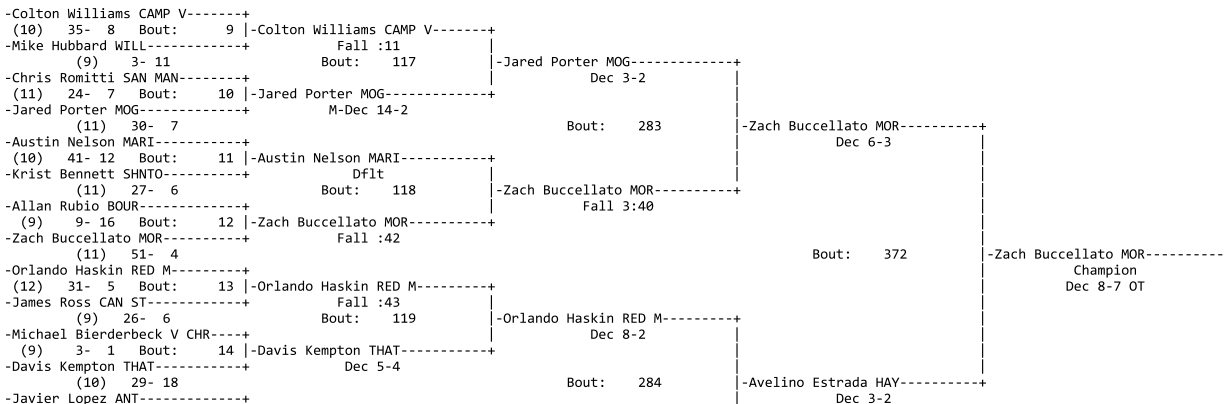

(10) 11- 4 Bout: 15 | -Bobby Bowden BENS-----+  
 -Bobby Bowden BENS-----+ Fall 4:29  
 (9) 24- 16 Bout: 120 | -Avelino Estrada HAY-----+  
 -Quanah Lee V SAND-----+ T-Fall 17-1  
 (10) 27- 16 Bout: 16 | -Avelino Estrada HAY-----+  
 -Avelino Estrada HAY-----+ M-Dec 10-0  
 (9) 32- 2 | -Jared Porter MOG-----+  
 -Mike Hubbard WILL-----+  
 Bout: 173 | -Chris Romitti SAN MAN-----+  
 -Chris Romitti SAN MAN-----+ Fall :14  
 Bout: 229 | -Chris Romitti SAN MAN-----+ Bout: 339 | -Jared Porter MOG-----+  
 -Bobby Bowden BENS-----+ M-Dec 16-6 | -Chris Romitti SAN MAN-----+ Dec 11-5  
 Bout: 311 | -Chris Romitti SAN MAN-----+ Dec 3-1  
 -Krist Bennett SHNTO-----+  
 Bout: 174 | -Allan Rubio BOUR-----+  
 -Allan Rubio BOUR-----+ Dflit  
 Bout: 230 | -Davis Kempton THAT-----+  
 -Davis Kempton THAT-----+ Fall 1:52  
 Bout: 371 | -Jared Porter MOG-----+  
 -James Ross CAN ST-----+ | 3rd Place  
 Bout: 175 | -James Ross CAN ST-----+ | Dec 6-4  
 -Michael Bierderbeck V CHR-----+ Fall 3:53  
 Bout: 231 | -Austin Nelson MARI-----+  
 -Austin Nelson MARI-----+ Fall 2:17  
 Bout: 312 | -Colton Williams CAMP V-----+  
 -Colton Williams CAMP V-----+ Dec 11-4  
 Bout: 340 | -Orlando Haskin RED M-----+  
 -Colton Williams CAMP V-----+ Fall 2:00 | -Orlando Haskin RED M-----+  
 Dec 5-2  
 -Chris Romitti SAN MAN-----+  
 Bout: 370 | -Colton Williams CAMP V-----+  
 -Colton Williams CAMP V-----+ 5th Place  
 Fall 2:56

- Place Winners -  
 1st Zach Buccellato MOR (11) 55- 4  
 2nd Avelino Estrada HAY (9) 35- 3  
 3rd Jared Porter MOG (11) 34- 8  
 4th Orlando Haskin RED M (12) 34- 7

- Place Winners -  
 5th Colton Williams CAMP V (10) 39- 10  
 6th Chris Romitti SAN MAN (11) 27- 10

Weight: 119

-Chance Kneece SAN PAS-----+  
 (12) 8- 1 Bout: 17 | -Chance Kneece SAN PAS-----+  
 -Vinson Six V SAND-----+ Dec 13-9  
 (12) 22- 6 Bout: 121 | -Chance Kneece SAN PAS-----+  
 -Brandon Beel BENS-----+ Dec 9-5  
 (11) 25- 16 Bout: 18 | -Brandon Beel BENS-----+  
 -Carlos Martinez SUP-----+ Dec 8-6  
 (12) 40- 13 Bout: 285 | -Rodney Growler RED M-----+  
 -Frankie Maldonado MOR-----+ | Dec 7-5  
 (11) 28- 16 Bout: 19 | -Frankie Maldonado MOR-----+  
 -J D Masterson MARI-----+ Dec 4-1  
 (9) 37- 12 Bout: 122 | -Rodney Growler RED M-----+  
 -Matt Lopez YUMA C-----+ | Dec 7-4  
 (9) 26- 19 Bout: 20 | -Rodney Growler RED M-----+  
 -Rodney Growler RED M-----+ Fall 1:46  
 (10) 23- 7 Bout: 376 | -Joe Clark SAN MAN-----+  
 -Joe Clark SAN MAN-----+ | Champion  
 (11) 43- 6 Bout: 21 | -Joe Clark SAN MAN-----+ | T-Fall 19-2  
 -Gloria Ortega BISB-----+ | Fall :46  
 1- 1 Bout: 123 | -Joe Clark SAN MAN-----+  
 -Adam Crandell MOG-----+ | M-Dec 12-2  
 (11) 28- 6 Bout: 22 | -Adam Crandell MOG-----+  
 -Wendall Ogle CAMP V-----+ Forf  
 (10) 20- 7 Bout: 286 | -Joe Clark SAN MAN-----+  
 -Micah Begay M FARMS-----+ | Dec 6-3  
 (11) 24- 10 Bout: 23 | -Arnold Coronado BOUR-----+  
 -Arnold Coronado BOUR-----+ Dec 12-6  
 (9) 26- 10 Bout: 124 | -Jeremiah Walpert WILL-----+  
 -Albert Miller CAN ST-----+ | Fall 1:13  
 (10) 23- 13 Bout: 24 | -Jeremiah Walpert WILL-----+  
 -Jeremiah Walpert WILL-----+ Fall :13  
 (10) 41- 6 | -Chance Kneece SAN PAS-----+  
 -Vinson Six V SAND-----+ | Bout: 341 | -Chance Kneece SAN PAS-----+  
 Bout: 177 | -Vinson Six V SAND-----+ | M-Dec 13-4  
 -Carlos Martinez SUP-----+ | Fall :50  
 Bout: 233 | -Vinson Six V SAND-----+  
 -Arnold Coronado BOUR-----+ Dec 7-3  
 Bout: 313 | -Adam Crandell MOG-----+  
 -J D Masterson MARI-----+ | Dec 6-0  
 Bout: 178 | -J D Masterson MARI-----+  
 -Matt Lopez YUMA C-----+ | M-Dec 14-2  
 Bout: 234 | -Adam Crandell MOG-----+  
 -Adam Crandell MOG-----+ | T-Fall 19-4  
 Bout: 375 | -Jeremiah Walpert WILL-----+  
 -Gloria Ortega BISB-----+ | 3rd Place  
 Bout: 179 | -Gloria Ortega BISB-----+ | Dec 9-2  
 -Wendall Ogle CAMP V-----+ | Dflit  
 Bout: 235 | -Frankie Maldonado MOR-----+  
 -Frankie Maldonado MOR-----+ Fall 1:50  
 Bout: 314 | -Frankie Maldonado MOR-----+  
 -Micah Begay M FARMS-----+ | Dec 3-0  
 Bout: 180 | -Micah Begay M FARMS-----+  
 -Albert Miller CAN ST-----+ | Fall 3:48  
 Bout: 236 | -Micah Begay M FARMS-----+ Bout: 342 | -Jeremiah Walpert WILL-----+  
 -Brandon Beel BENS-----+ | Dec 7-4 | -Jeremiah Walpert WILL-----+  
 M-Dec 12-0  
 -Adam Crandell MOG-----+  
 Bout: 374 | -Adam Crandell MOG-----+  
 -Frankie Maldonado MOR-----+ 5th Place  
 Fall 4:18

- Place Winners -  
 1st Joe Clark SAN MAN (11) 47- 6  
 2nd Rodney Growler RED M (10) 26- 8  
 3rd Jeremiah Walpert WILL (10) 45- 7  
 4th Chance Kneece SAN PAS (12) 11- 3

- Place Winners -  
 5th Adam Crandell MOG (11) 32- 8  
 6th Frankie Maldonado MOR (11) 31- 19

Weight: 125

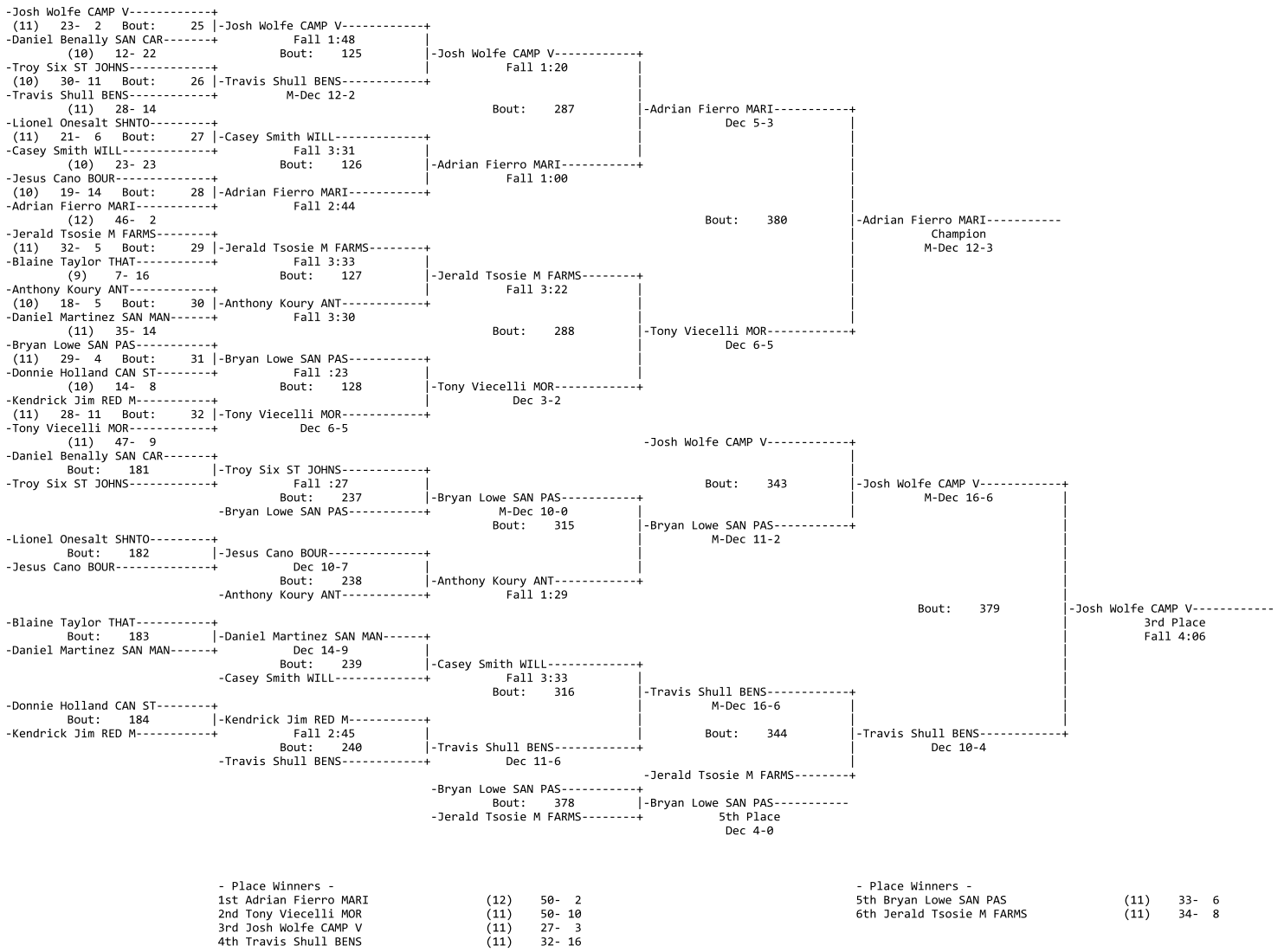

Weight: 130

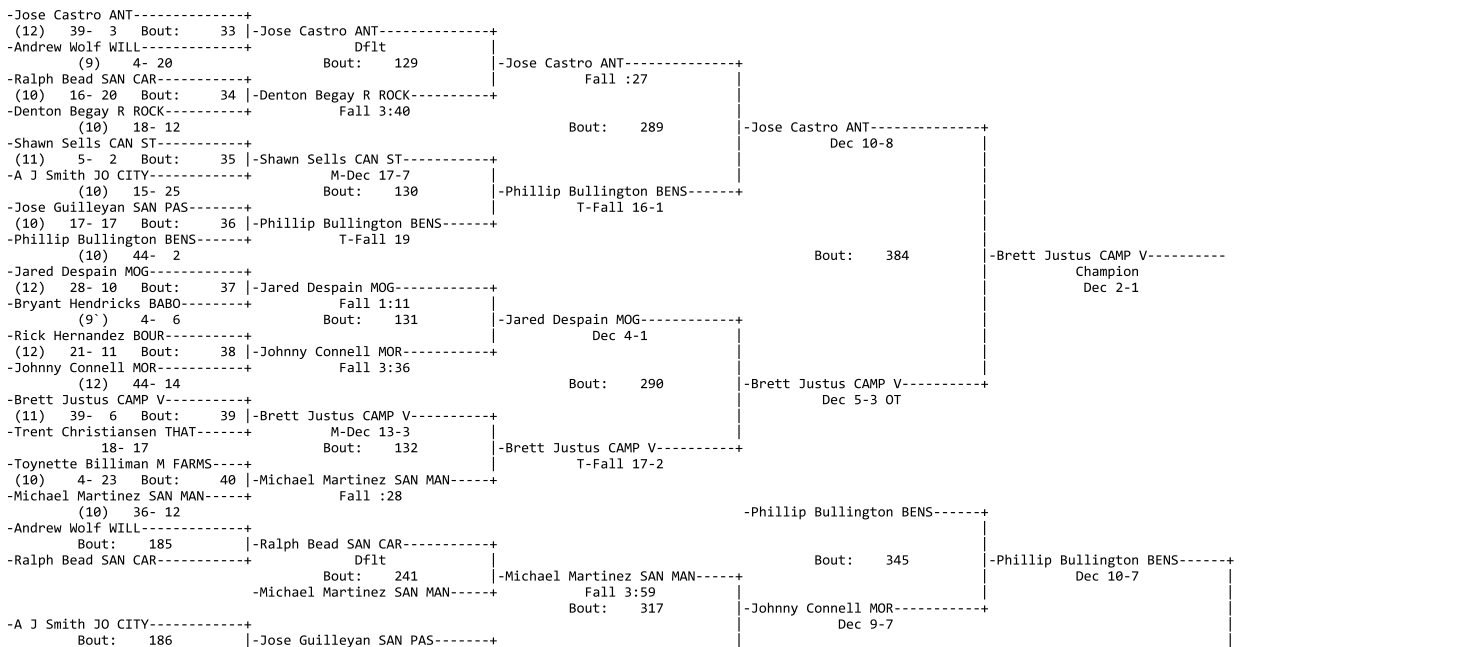

Brackets

```

- Jose Guilleyan SAN PAS-----+ Dec 12-11          | -Johnny Connell MOR-----+
      Bout: 242      |      Fall :54
- Johnny Connell MOR-----+
- Bryant Hendricks BABO-----+ | -Rick Hernandez BOUR-----+
      Bout: 187      |      Fall 1:46
- Rick Hernandez BOUR-----+ |      Bout: 243      | -Rick Hernandez BOUR-----+
      |              |      Dec 12-11      |      Bout: 318      | -Rick Hernandez BOUR-----+
      |              |      Bout: 318      |      Dec 4-2        |
- Trent Christiansen THAT-----+ | -Trent Christiansen THAT-----+
      Bout: 188      |      Fall 1:51      |      Bout: 346      | -Jared Despaign MOG-----+
- Toynette Billiman M FARMS-----+ |      Bout: 244      |      Dec 8-0        |
      |              |      Dec 4-2        |
      |              |      Bout: 382      | -Johnny Connell MOR-----+
      |              |      Bout: 382      |      Bout: 382      | -Johnny Connell MOR-----+
      |              |      5th Place     |      5th Place     |
      |              |      M-Dec 13-0    |      M-Dec 13-0    |
      |              |
- Place Winners -
1st Brett Justus CAMP V          (11) 43- 6
2nd Jose Castro ANT              (12) 42- 4
3rd Phillip Bullington BENS     (10) 48- 3
4th Jared Despaign MOG         (12) 31- 12
- Place Winners -
5th Johnny Connell MOR          (12) 48- 16
6th Rick Hernandez BOUR        (12) 24- 14
  
```

Weight: 135

```

- Jacob Wolfe CAMP V-----+ (10) 36- 7 Bout: 41 | -Jacob Wolfe CAMP V-----+
      |              |      Fall :40
- Eric Yazzie V SAND-----+ |      Bout: 133      | -Jacob Wolfe CAMP V-----+
      |              |      M-Dec 15-7      |
      |              |      Bout: 291      | -Ray Morales MOR-----+
- Justin Greene BENS-----+ |      Bout: 291      |      M-Dec 13-4      |
- Joshua Monroy HAY-----+ (10) 25- 5          |      |
      |              |      Bout: 291      | -Ray Morales MOR-----+
- Ray Morales MOR-----+ |      Bout: 291      |      M-Dec 13-4      |
- Fernando Chavarria SAN MAN-----+ |      Bout: 134      | -Ray Morales MOR-----+
      |              |      T-Fall 19      |      T-Fall 21-5      |
- Jacob Skousen ANT-----+ |      Bout: 134      |      T-Fall 21-5      |
- Ferdinand Hot RED M-----+ |      Bout: 44      | -Ferdinand Hot RED M-----+
      |              |      Fall 1:04      |      Bout: 388      | -Ray Morales MOR-----+
- Cesar Zepada MARI-----+ |      Bout: 44      |      Champion      |
- D Gunauley BISB-----+ (12) 13- 2 Bout: 45 | -Cesar Zepada MARI-----+
      |              |      Fall :40      |      Dec 18-11      |
- Jeremiah Muzzy MOG-----+ |      Bout: 135      | -Cesar Zepada MARI-----+
      |              |      Fall 1:30      |
- Jacob Cummins PHX CHR-----+ |      Bout: 292      | -Cesar Zepada MARI-----+
- Nick Dejesus JO CITY-----+ |      Bout: 292      |      Dec 12-7        |
- Derek Clements SAN PAS-----+ |      Bout: 136      | -Denver Householder THAT-----+
      |              |      Dec 9-5        |      M-Dec 13-1      |
- Johnny Espindola CAN ST-----+ |      Bout: 48      | -Jacob Wolfe CAMP V-----+
- Denver Householder THAT-----+ |      Bout: 48      |      Bout: 347      | -Jacob Wolfe CAMP V-----+
- Eric Yazzie V SAND-----+ |      Bout: 189      |      Dec 5-0        |
- Joshua Monroy HAY-----+ |      Bout: 189      |
      |              |      Bout: 319      | -Derek Clements SAN PAS-----+
      |              |      Fall 4:04      |      Dec 7-4        |
- Fernando Chavarria SAN MAN-----+ |      Bout: 190      | -Jacob Skousen ANT-----+
- Jacob Skousen ANT-----+ |      Bout: 246      |      Fall 2:13      |
- D Gunauley BISB-----+ |      Bout: 191      | -Jacob Skousen ANT-----+
- Jacob Cummins PHX CHR-----+ |      Bout: 247      | -Jacob Skousen ANT-----+
      |              |      M-Dec 10-2     |
      |              |      Bout: 246      | -Jeremiah Muzzy MOG-----+
      |              |      Dec 11-6      |
- Ferdinand Hot RED M-----+ |      Bout: 320      | -Ferdinand Hot RED M-----+
- Nick Dejesus JO CITY-----+ |      Bout: 192      |      Dec 10-8      |
- Johnny Espindola CAN ST-----+ |      Bout: 248      |      Bout: 348      | -Denver Householder THAT-----+
      |              |      Dec 3-1        |      Dec 6-2        |
      |              |      Bout: 348      |
      |              |      Dec 2:26      |
      |              |      Bout: 386      | -Derek Clements SAN PAS-----+
      |              |      Bout: 386      |      Bout: 386      | -Derek Clements SAN PAS-----+
      |              |      5th Place     |      5th Place     |
      |              |      Fall 3:49    |      Fall 3:49    |
- Place Winners -
1st Ray Morales MOR          (12) 51- 3
2nd Cesar Zepada MARI      (12) 16- 3
3rd Jacob Wolfe CAMP V     (10) 40- 8
4th Denver Householder THAT (10) 32- 9
- Place Winners -
5th Derek Clements SAN PAS (12) 28- 8
6th Ferdinand Hot RED M    (11) 35- 12
  
```

Weight: 140

```

- Joseph Wolfe CAMP V-----+ (9) 26- 7 Bout: 49 | -Joseph Wolfe CAMP V-----+
      |              |      Fall 1:13
- Dominique Monoz CAN ST-----+ |      Bout: 137      | -Armand Morales MOR-----+
      |              |      Fall 3:24
- Mat Lee V SAND-----+ (10) 34- 9 Bout: 50 | -Armand Morales MOR-----+
      |              |      Dec 13-6
- Armand Morales MOR-----+ |      Bout: 293      | -Boyd Scofield MARI-----+
      |              |      Bout: 293      |      Fall 1:58
- Drew Herrick ST JOHNS-----+ |      Bout: 51      | -Cory Graf BENS-----+
- Cory Graf BENS-----+
  
```

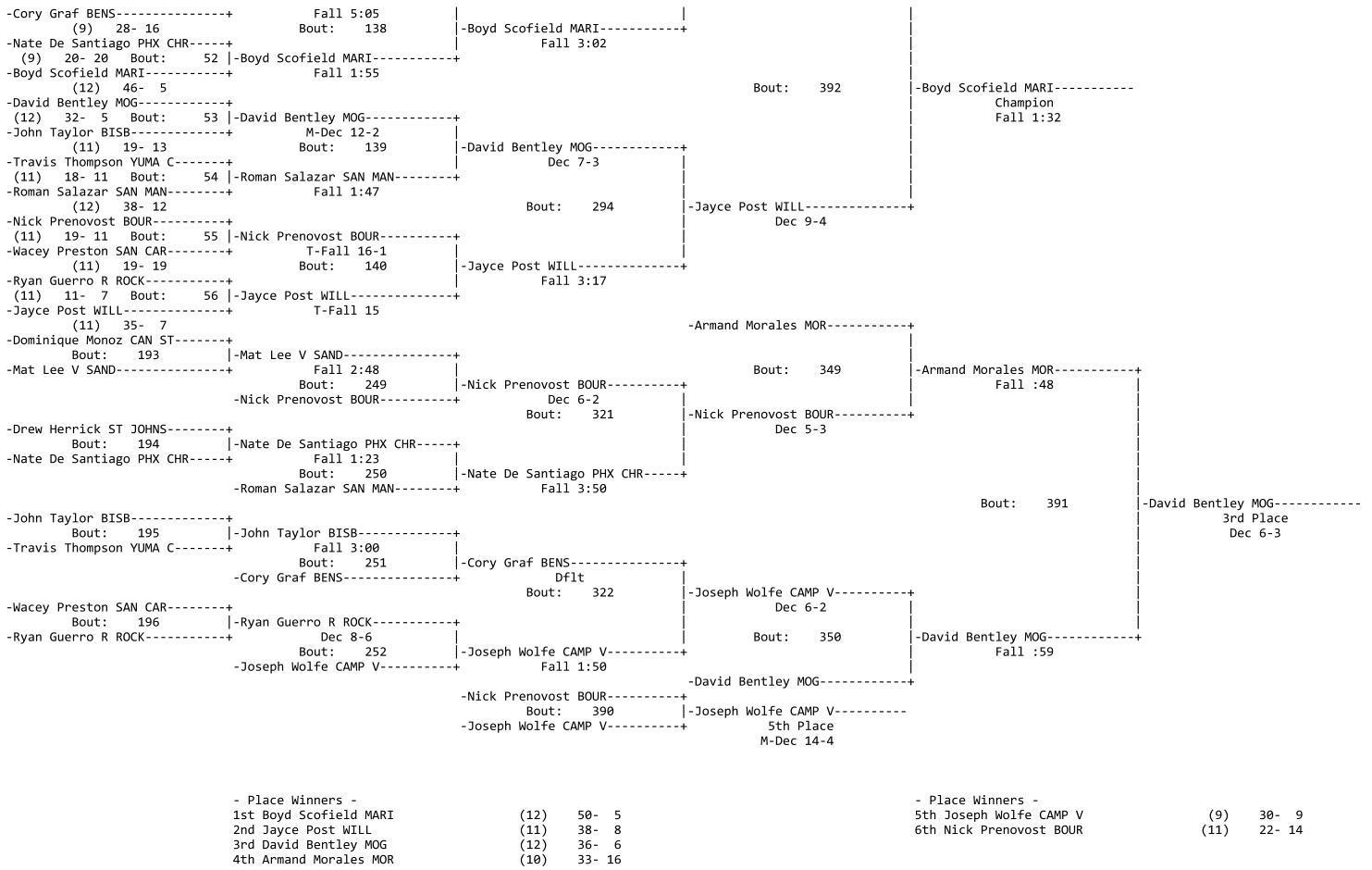

Weight: 145

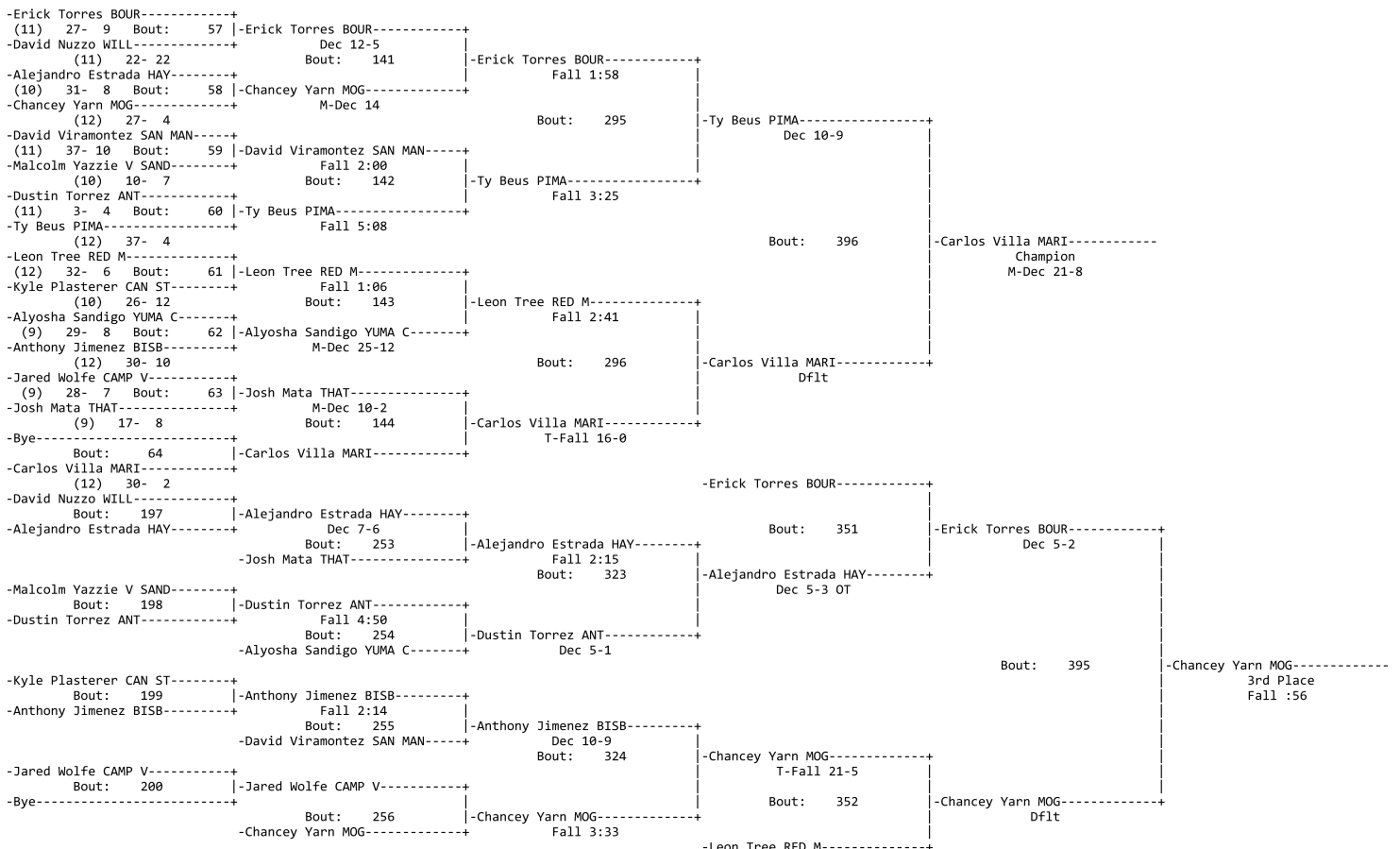

-Alejandro Estrada HAY-----+  
 Bout: 394 | -Alejandro Estrada HAY-----+  
 5th Place  
 -Leon Tree RED M-----+  
 DflT

- Place Winners -  
 1st Carlos Villa MARI  
 2nd Ty Beus PIMA  
 3rd Chancey Yarn MOG  
 4th Erick Torres BOUR

(12) 33- 2  
 (12) 40- 5  
 (12) 32- 5  
 (11) 30- 11

- Place Winners -  
 5th Alejandro Estrada HAY  
 6th Leon Tree RED M

(10) 35- 10  
 (12) 34- 9

Weight: 152

-Tyler Hancock CAMP V-----+  
 (12) 36- 6 Bout: 65 | -Tyler Hancock CAMP V-----+  
 -Donovan Wilson R ROCK-----+  
 (10) 12- 17 Bout: 145 | Fall 4:24  
 -Justin Snyder WILL-----+  
 (11) 24- 17 Bout: 66 | -Daniel Buelna SAN MAN-----+  
 -Daniel Buelna SAN MAN-----+  
 (12) 28- 12 Dec 10-8 | Bout: 297  
 -Jaymes Bernal BENS-----+  
 (11) 22- 11 Bout: 67 | -Corey Zollenger CAN ST-----+  
 -Corey Zollenger CAN ST-----+  
 (11) 27- 11 Bout: 146 | Fall 4:10  
 -Sergio Rodriguez SAN PAS-----+  
 (10) 22- 11 Bout: 68 | -Blake Solomon JO CITY-----+  
 -Blake Solomon JO CITY-----+  
 (11) 45- 1 Fall 3:20 | Bout: 400  
 -Felix Monroy HAY-----+  
 (11) 23- 4 Bout: 69 | -Felix Monroy HAY-----+  
 -Grady Crockett PIMA-----+  
 (12) 21- 13 Bout: 147 | Fall 1:17  
 -Justin Chee PINON-----+  
 (12) 15- 11 Bout: 70 | -Hugo Ramos BOUR-----+  
 -Hugo Ramos BOUR-----+  
 (11) 30- 7 Fall 2:44 | Bout: 298  
 -Shad Bride ST JOHNS-----+  
 (9) 32- 12 Bout: 71 | -Shad Bride ST JOHNS-----+  
 -Curtis Fowler ANT-----+  
 (10) 21- 9 Bout: 148 | Fall 5:27  
 -Kenny Magallanez SUP-----+  
 (10) 38- 20 Bout: 72 | -Heath Allred THAT-----+  
 -Heath Allred THAT-----+  
 (11) 21- 1 Fall :27 | Bout: 353  
 -Donovan Wilson R ROCK-----+  
 Bout: 201 | -Justin Snyder WILL-----+  
 -Justin Snyder WILL-----+  
 Bout: 257 | Fall 2:24  
 -Shad Bride ST JOHNS-----+  
 -Shad Bride ST JOHNS-----+  
 Bout: 325 | M-Dec 12-1  
 -Jaymes Bernal BENS-----+  
 Bout: 202 | -Jaymes Bernal BENS-----+  
 -Sergio Rodriguez SAN PAS-----+  
 Dec 15-8 | Bout: 258  
 -Hugo Ramos BOUR-----+  
 Fall 4:54 | Bout: 399  
 -Grady Crockett PIMA-----+  
 Bout: 203 | -Grady Crockett PIMA-----+  
 -Justin Chee PINON-----+  
 Dec 9-5 | Bout: 259  
 -Corey Zollenger CAN ST-----+  
 -Corey Zollenger CAN ST-----+  
 Fall 3:45 | Bout: 326  
 -Curtis Fowler ANT-----+  
 Bout: 204 | -Kenny Magallanez SUP-----+  
 -Kenny Magallanez SUP-----+  
 Dec 11-8 | Bout: 260  
 -Daniel Buelna SAN MAN-----+  
 Dec 7-5 | Bout: 354  
 -Shad Bride ST JOHNS-----+  
 Bout: 398 | -Shad Bride ST JOHNS-----+  
 -Kenny Magallanez SUP-----+  
 Fall 2:49 | 5th Place  
 -Place Winners -  
 1st Blake Solomon JO CITY (11) 49- 1  
 2nd Heath Allred THAT (11) 24- 2  
 3rd Felix Monroy HAY (11) 27- 5  
 4th Tyler Hancock CAMP V (12) 39- 8  
 -Place Winners -  
 5th Shad Bride ST JOHNS (9) 36- 14  
 6th Kenny Magallanez SUP (10) 41- 23

Weight: 160

-Damien Baca CAMP V-----+  
 (10) 40- 4 Bout: 73 | -Damien Baca CAMP V-----+  
 -William Polk SAN CAR-----+  
 (9) 8- 19 Bout: 149 | Fall :12  
 -Wacey Jones M FARMS-----+  
 (12) 23- 10 Bout: 74 | -D Behle V UNION-----+  
 -D Behle V UNION-----+  
 (11) 22- 11 Fall 2:54 | Bout: 299  
 -Joel Frazier ST JOHNS-----+  
 (12) 36- 4 Bout: 75 | -Joel Frazier ST JOHNS-----+  
 -Justin Thompson THAT-----+  
 (12) 19- 20 Bout: 150 | Dec 16-13  
 -Dewey Womack ANT-----+  
 (10) 24- 15 Bout: 76 | -Porter Fensel MARI-----+  
 -Porter Fensel MARI-----+  
 (12) 9- 1 Fall 1:02 | Bout: 404  
 -Casey Petersen JO CITY-----+  
 (12) 36- 7 Bout: 77 | -Casey Petersen JO CITY-----+  
 -James Anger PIMA-----+  
 (10) 35- 15 Bout: 151 | M-Dec 15-2  
 -Erick Ramirez SAN PAS-----+  
 (12) 29- 5 Bout: 78 | -Wade Monfred SAN MAN-----+  
 -Wade Monfred SAN MAN-----+  
 (12) 39- 13 T-Fall 15 | Bout: 300  
 -Tom Brown PREC-----+  
 (11) 16- 3 Bout: 79 | -Tom Brown PREC-----+  
 Dec 7-5  
 -Damien Baca CAMP V-----+  
 Champion  
 Dec 18-3





Weight: 189

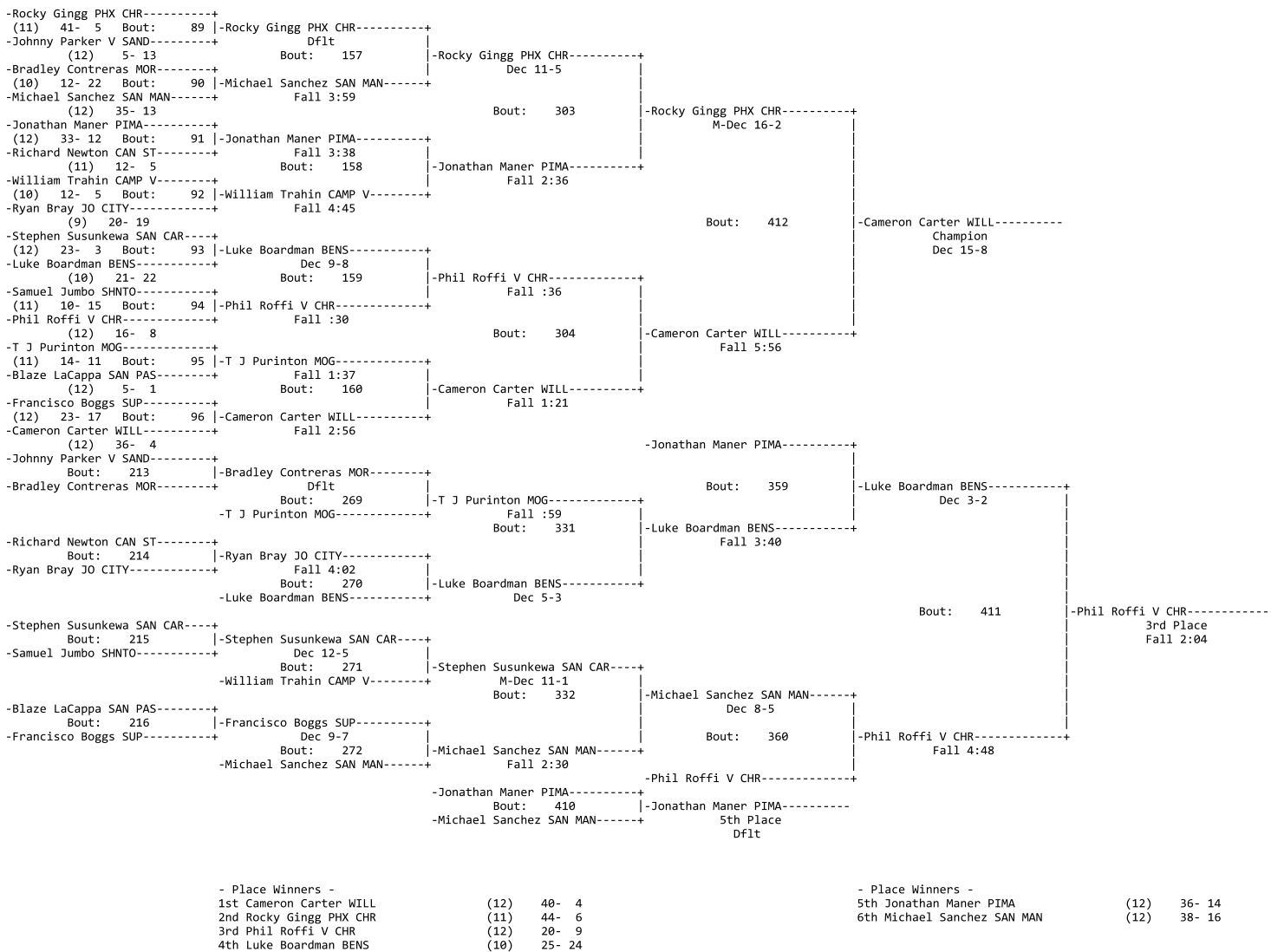

Weight: 215

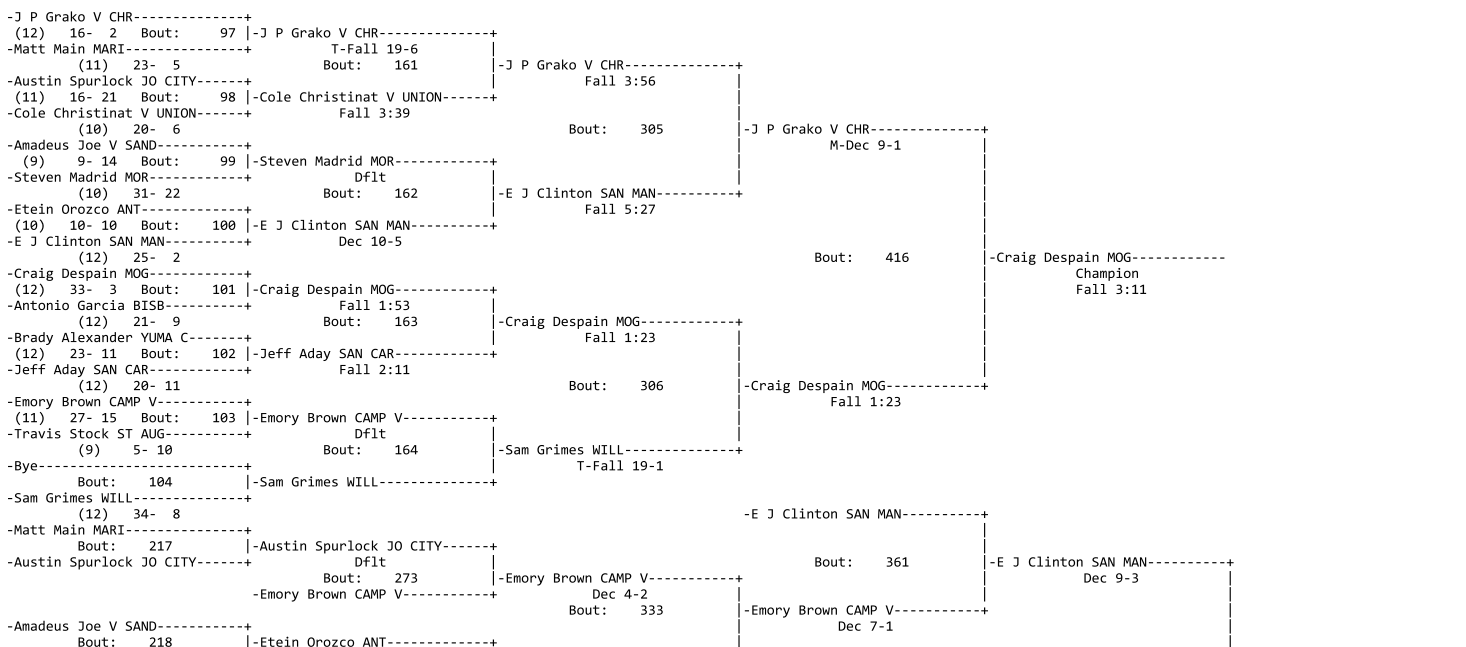



Glendale Arena

**2006 Arizona 3A State Meet****Team Scores**

February 10-11, 2006

---

1.	Safford	227.50
2.	Payson	164.50
3.	Show Low	147.00
4.	Winslow	113.00
5.	Fountain Hills	108.50
6.	Coolidge	97.50
7.	Parker	89.00
7. (tie)	Estrella Foothills	89.00
9.	Snowflake	82.50
10.	Holbrook	76.50
11.	Sahuarita	69.50
12.	Blue Ridge	61.50
13.	Santa Cruz	60.50
14.	Greyhills	46.00
15.	Round Valley	45.50
15. (tie)	Tuba City	45.50
17.	Chinle	39.00
18.	Ganado	37.50
19.	Monument Valley	31.00
20.	Seton Catholic	27.00
21.	Wickenburg	19.00
22.	Window Rock	18.00
22. (tie)	River Valley	18.00
24.	Chino Valley	10.00
25.	Florence	9.00
26.	Hopi	7.00
27.	Alchesay	6.00
28.	Sedona	0.00
28. (tie)	Globe	0.00
28. (tie)	Empire	0.00

**Tourney Contact**

Greg Wayne

Monument Valley

PO Box 337

Kayenta AZ 86033

e-mail: [gwayne@kayenta.k12.az.us](mailto:gwayne@kayenta.k12.az.us)**Publisher****Preferred Educational Software**

221 Rivers Edge Drive

Cherry Valley IL 61010

Phone: (888) 959-2016

e-mail: [cotterk@pes-sports.com](mailto:cotterk@pes-sports.com)

© 2005 - All rights reserved

# 2006 Arizona 3A State Meet Glendale Arena February 10-11, 2006

## Weight: 103

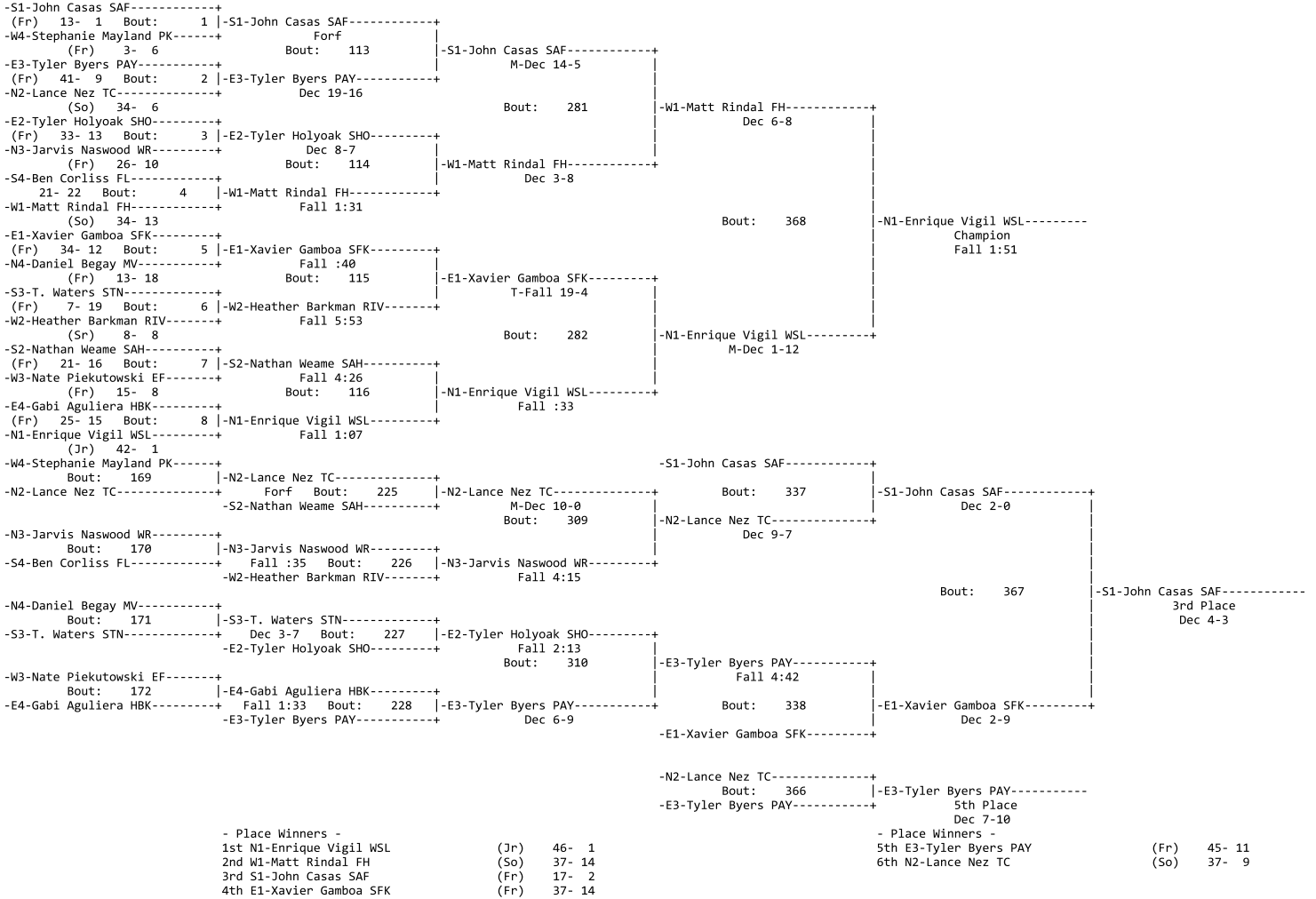

## Weight: 112

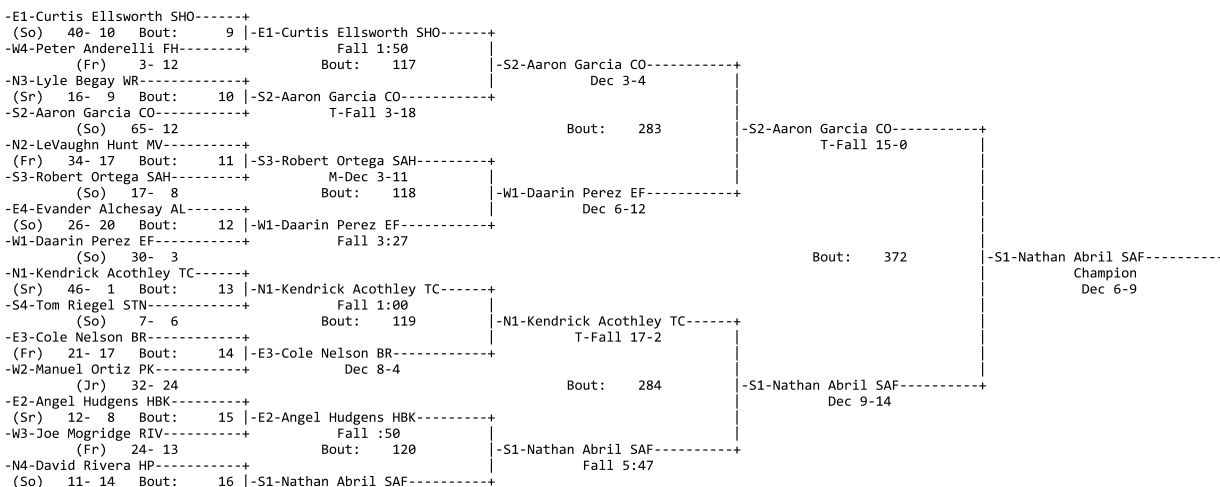

```

-1-Nathan Abril SAF-----+           Forf
   (Fr) 31- 5
-14-Peter Anderelli FH-----+
   Bout: 173
-13-Lyle Begay WR-----+
   M-Dec 5-15 Bout: 229
-2-Angel Hudgens HBK-----+
   Dec 6-10
   Bout: 311
-2-LeVaughn Hunt MV-----+
   Bout: 174
-4-Evander Alchey AL-----+
   M-Dec 11-2 Bout: 230
-3-Cole Nelson BR-----+
   Dec 6-10
-4-Tom Riegel STN-----+
   Bout: 175
-2-Manuel Ortiz PK-----+
   Dec 6-7 Bout: 231
-3-Robert Ortega SAH-----+
   M-Dec 1-9
   Bout: 312
-3-Joe Mogridge RIV-----+
   Bout: 176
-4-David Rivera HP-----+
   Forf Bout: 232
-1-Curtis Ellsworth SHO-----+
   Fall 2:46
-1-Daarin Perez EF-----+
   Bout: 339
   Dec 8-6
-2-Angel Hudgens HBK-----+
   Fall 2:49
-3-Cole Nelson BR-----+
   Dec 6-10
   Bout: 371
-1-Kendrick Acothley TC-----+
   3rd Place
   Dec 5-10
-1-Curtis Ellsworth SHO-----+
   T-Fall 4-20
   Bout: 340
-1-Kendrick Acothley TC-----+
   Dec 5-8
-2-Angel Hudgens HBK-----+
   Bout: 370
-1-Curtis Ellsworth SHO-----+
   5th Place
   Dec 3-7
- Place Winners -
1st 1-Nathan Abril SAF           (Fr) 35- 5
2nd 2-Aaron Garcia CO           (So) 68- 13
3rd 1-Kendrick Acothley TC       (Sr) 50- 2
4th 1-Daarin Perez EF           (So) 33- 5
-1-Curtis Ellsworth SHO-----+
   Dec 3-7
- Place Winners -
5th 1-Curtis Ellsworth SHO       (So) 44- 12
6th 2-Angel Hudgens HBK         (Sr) 15- 11
    
```

**Weight: 119**

```

-1-Jerod Flores PK-----+
   (Fr) 50- 4 Bout: 17
-4-Andy Chelsey SFK-----+
   (Fr) 0- 0 Bout: 121
-3-Anthony Vidales SAF-----+
   (So) 31- 13 Bout: 18
-2-Kirk Ramsey WSL-----+
   (So) 23- 11
-2-Ramon Cassillas SAH-----+
   (So) 29- 13 Bout: 19
-3-Aziz Nurakhtov WR-----+
   Dec 11-13
   Bout: 122
-4-Gilbert Sommer WKB-----+
   (So) 28- 13 Bout: 20
-1-Josh Taylor ROU-----+
   T-Fall 0-17
   (Jr) 40- 3
-1-Eric Garcia CO-----+
   (Jr) 59- 1 Bout: 21
-4-Michael Johnson MV-----+
   (Jr) 18- 11
   Bout: 123
-3-Kyle Curtin FH-----+
   (Jr) 28- 13 Bout: 22
-2-Markos Serna HBK-----+
   (Fr) 31- 6
-2-Ricky Perez EF-----+
   (Jr) 41- 7 Bout: 23
-3-Jeff Crandell SHO-----+
   M-Dec 15-7
   Bout: 124
-4-Travis Chase EM-----+
   (Fr) 10- 15 Bout: 24
-1-Clyde Yellowhair CHN-----+
   Forf
   (Jr) 36- 5
-4-Andy Chelsey SFK-----+
   Bout: 177
-2-Kirk Ramsey WSL-----+
   Fall :33 Bout: 233
-1-Clyde Yellowhair CHN-----+
   M-Dec 0-10
   Bout: 313
-2-Ramon Cassillas SAH-----+
   Bout: 178
-4-Gilbert Sommer WKB-----+
   M-Dec 10-2 Bout: 234
-2-Markos Serna HBK-----+
   Fall 4:41
-4-Michael Johnson MV-----+
   Bout: 179
-3-Kyle Curtin FH-----+
   Dec 2-13 Bout: 235
-3-Aziz Nurakhtov WR-----+
   Dec 11-6
   Bout: 314
-3-Jeff Crandell SHO-----+
   Bout: 180
-4-Travis Chase EM-----+
   Forf Bout: 236
-3-Anthony Vidales SAF-----+
   Dec 9-2
-1-Jerod Flores PK-----+
   Fall 1:00
-1-Jerod Flores PK-----+
   Dec 9-7
-1-Josh Taylor ROU-----+
   Fall 2:43
-1-Eric Garcia CO-----+
   Dec 13-9
-1-Eric Garcia CO-----+
   M-Dec 14-2
-2-Ricky Perez EF-----+
   Dec 10-6
-1-Josh Taylor ROU-----+
   Bout: 376
-1-Eric Garcia CO-----+
   T-Fall 0-16
-2-Markos Serna HBK-----+
   Dec 3-8
   Bout: 375
-1-Josh Taylor ROU-----+
   Dec 10-3
-3-Kyle Curtin FH-----+
   Dec 5-12
-2-Ricky Perez EF-----+
   M-Dec 7-15
-2-Markos Serna HBK-----+
   Bout: 374
-3-Jeff Crandell SHO-----+
   5th Place
   Dec 11-5
- Place Winners -
1st 1-Eric Garcia CO           (Jr) 63- 1
2nd 1-Jerod Flores PK           (Fr) 53- 5
3rd 1-Josh Taylor ROU           (Jr) 44- 4
4th 2-Ricky Perez EF           (Jr) 44- 9
-1-Josh Taylor ROU-----+
   Bout: 341
-2-Markos Serna HBK-----+
   Dec 3-8
   Bout: 375
-1-Josh Taylor ROU-----+
   Dec 9-7
-3-Jeff Crandell SHO-----+
   Bout: 342
-2-Ricky Perez EF-----+
   M-Dec 7-15
-2-Markos Serna HBK-----+
   Bout: 374
-3-Jeff Crandell SHO-----+
   5th Place
   Dec 11-5
- Place Winners -
5th 2-Markos Serna HBK         (Fr) 35- 8
6th 3-Jeff Crandell SHO         (Jr) 32- 21
    
```

**Weight: 125**

```

-1-Riley Stevens CHN-----+
   (Sr) 35- 6 Bout: 25
-4-Michael Escorza PK-----+
   Dflt
   (Fr) 32- 23 Bout: 125
-3-Jimmy Gutierrez SAF-----+
   (So) 25- 10 Bout: 26
-2-Tyler Goodman PAY-----+
   (Sr) 40- 8
-2-Carlos Coronado SAH-----+
   (Jr) 17- 5 Bout: 27
-1-Riley Stevens CHN-----+
-2-Tyler Goodman PAY-----+
   Fall 3:29
   Bout: 287
-2-Tyler Goodman PAY-----+
   Dec 10-3
-3-Richard Serna HBK-----+
    
```

-E3-Richard Serna HBK-----+ Fall 3:41  
(So) 27- 12 Bout: 126  
-N4-Hoover Nusingoetewa HP-----+  
(Sr) 11- 12 Bout: 28 | -W1-Josh Kasumovic FH-----+  
-W1-Josh Kasumovic FH-----+ Fall 5:41  
(Jr) 36- 9 Bout: 380  
-S1-Aaron Belloc SCZ-----+ | -E1-Anthony Martinez BR-----+  
(So) 25- 0 Bout: 29 | -S1-Aaron Belloc SCZ-----+ | Champion  
-E4-Bryce Bigham ROU-----+ | Fall 5:17 | Dec 3-5  
(So) 24- 11 Bout: 127 | -S1-Aaron Belloc SCZ-----+  
-N3-Justin Garcia WSL-----+ | Dec 12-5  
(Jr) 25- 8 Bout: 30 | -W2-Alex Bennett WKB-----+  
-W2-Alex Bennett WKB-----+ Fall 2:39 Bout: 288  
(Sr) 12- 3 | -E1-Anthony Martinez BR-----+  
-N2-Quintin Curley GAN-----+ | Dec 4-7  
(Sr) 27- 11 Bout: 31 | -N2-Quintin Curley GAN-----+  
-W3-Anthony Coronel RIV-----+ | T-Fall 17-1 |  
(Fr) 16- 23 Bout: 128 | -E1-Anthony Martinez BR-----+  
-S4-Eric Dunton FL-----+ | Fall 5:14  
28- 27 Bout: 32 | -E1-Anthony Martinez BR-----+  
-E1-Anthony Martinez BR-----+ | Fall :45  
(Sr) 51- 0  
-W4-Michael Escorza PK-----+ |  
Bout: 181 | -S3-Jimmy Guterrez SAF-----+  
-S3-Jimmy Guterrez SAF-----+ | Forf Bout: 237 | -S3-Jimmy Guterrez SAF-----+  
-N2-Quintin Curley GAN-----+ | Dec 9-6 | Bout: 315  
-S2-Carlos Coronado SAH-----+ | -S3-Jimmy Guterrez SAF-----+  
Bout: 182 | -S2-Carlos Coronado SAH-----+ | Dec 6-4  
-N4-Hoover Nusingoetewa HP-----+ | Fall 5:01 Bout: 238 | -W2-Alex Bennett WKB-----+  
-W2-Alex Bennett WKB-----+ | Fall :24 | Bout: 379  
-E4-Bryce Bigham ROU-----+ | -E4-Bryce Bigham ROU-----+ | -S1-Aaron Belloc SCZ-----+  
Bout: 183 | M-Dec 13-5 Bout: 239 | 3rd Place  
-N3-Justin Garcia WSL-----+ | -W1-Josh Kasumovic FH-----+ | Dec 2-4  
-W1-Josh Kasumovic FH-----+ | M-Dec 0-14 |  
-W3-Anthony Coronel RIV-----+ | Bout: 316 | -W1-Josh Kasumovic FH-----+  
Bout: 184 | Dec 7-3 | -W1-Josh Kasumovic FH-----+  
-S4-Eric Dunton FL-----+ | -S4-Eric Dunton FL-----+ | Dec 3-7 Bout: 240 | -N1-Riley Stevens CHN-----+ | -S1-Aaron Belloc SCZ-----+  
-N1-Riley Stevens CHN-----+ | Fall 4:20 | Bout: 344 | Dec 2-3  
-S1-Aaron Belloc SCZ-----+  
-S3-Jimmy Guterrez SAF-----+ |  
Bout: 378 | -W1-Josh Kasumovic FH-----+  
-W1-Josh Kasumovic FH-----+ | Dec 3-7 |  
- Place Winners -  
1st E1-Anthony Martinez BR (Sr) 55- 0  
2nd E2-Tyler Goodman PAY (Sr) 43- 9  
3rd S1-Aaron Belloc SCZ (So) 29- 1  
4th E3-Richard Serna HBK (So) 30- 14

Weight: 130

-S1-Rito Rios SAF-----+  
(Jr) 43- 5 Bout: 33 | -S1-Rito Rios SAF-----+  
-W4-Nico Contreras EF-----+ | Fall 2:35  
(So) 17- 18 Bout: 129  
-E3-Dan McGee PAY-----+ | -S1-Rito Rios SAF-----+  
(So) 36- 14 Bout: 34 | -N2-Douglas Etsitty CHN-----+ | T-Fall 17-2  
-N2-Douglas Etsitty CHN-----+ | Forf | Bout: 289  
(Jr) 24- 12  
-E2-Paul Kakavas SHO-----+ | -E2-Paul Kakavas SHO-----+  
(Sr) 25- 10 Bout: 35 | Dec 16-11 | -E2-Paul Kakavas SHO-----+  
-N3-Tommy Taylor WSL-----+ | Bout: 130 | Forf  
-S4-Jeremiah Moreno CO-----+ | -W1-Seth Carpenter PK-----+  
(Sr) 111- 18 Bout: 36 | M-Dec 3-12 | Bout: 384  
-W1-Seth Carpenter PK-----+ | (Jr) 52- 11  
-E1-Bo Mortensen SFK-----+ | -E1-Bo Mortensen SFK-----+ | -E1-Bo Mortensen SFK-----+  
(Sr) 32- 5 Bout: 37 | Fall 3:25 | Champion  
-N4-Daniel Damon WR-----+ | Bout: 131 | Dec 3-6  
(Fr) 1- 2 | -E1-Bo Mortensen SFK-----+ |  
-S3-David Lerma SAH-----+ | M-Dec 14-2 |  
(Sr) 32- 8 Bout: 38 | -S3-David Lerma SAH-----+ |  
-W2-Thomas Gallagher WKB-----+ | T-Fall 15-0 |  
(Sr) 27- 15 | Bout: 290  
-S2-Jimmy Nguyen STN-----+ | -E1-Bo Mortensen SFK-----+  
(12) 21- 7 Bout: 39 | Dec 5-4  
-W3-Anthony Graziano FH-----+ | Dec 8-4 |  
(So) 35- 8 Bout: 132 | -S2-Jimmy Nguyen STN-----+  
-E4-Ryan Martinez BR-----+ | Dec 4-3  
(So) 37- 17 Bout: 40 | -N1-Kyle Johnson GAN-----+  
-N1-Kyle Johnson GAN-----+ | Dec 4-9 |  
(Sr) 36- 5  
-W4-Nico Contreras EF-----+ | -W4-Nico Contreras EF-----+  
Bout: 185 | Forf Bout: 241 | -N1-Kyle Johnson GAN-----+  
-E3-Dan McGee PAY-----+ | T-Fall 0-17 | Bout: 345  
-N1-Kyle Johnson GAN-----+ | Bout: 317 | Dec 8-6  
-N3-Tommy Taylor WSL-----+ | -N3-Tommy Taylor WSL-----+ |  
Bout: 186 | Fall 2:48 Bout: 242 | -S3-David Lerma SAH-----+  
-S4-Jeremiah Moreno CO-----+ | -S3-David Lerma SAH-----+ | Dec 5-7  
-N4-Daniel Damon WR-----+ | -W2-Thomas Gallagher WKB-----+ |  
Bout: 187 | Fall 3:45 Bout: 243 | -W2-Thomas Gallagher WKB-----+  
-W2-Thomas Gallagher WKB-----+ | DflT INJURY |  
-W1-Seth Carpenter PK-----+ | Bout: 318 |  
-W3-Anthony Graziano FH-----+ | -W3-Anthony Graziano FH-----+  
Bout: 188 | Dec 3-2 Bout: 244 | Dec 2-4  
-E4-Ryan Martinez BR-----+ | -N2-Douglas Etsitty CHN-----+ | Bout: 346  
-N2-Douglas Etsitty CHN-----+ | M-Dec 12-2 | -S2-Jimmy Nguyen STN-----+  
-S2-Jimmy Nguyen STN-----+ | Dec 2-3  
-E2-Paul Kakavas SHO-----+ |  
Bout: 382 | -E2-Paul Kakavas SHO-----+  
-W3-Anthony Graziano FH-----+ | 5th Place  
Fall 2:10  
- Place Winners -  
1st E1-Bo Mortensen SFK (Sr) 36- 5  
2nd S1-Rito Rios SAF (Jr) 46- 6  
5th E2-Paul Kakavas SHO (Sr) 28- 12  
6th W3-Anthony Graziano FH (So) 38- 11

3rd S2-Jimmy Nguyen STN (12) 25- 8  
4th N1-Kyle Johnson GAN (Sr) 40- 7

Weight: 135

-E1-Lee Perez PAY-----+  
(Sr) 39- 5 Bout: 41 | -E1-Lee Perez PAY-----+  
-W4-Roberto Gregorio EF-----+  
(Jr) 23- 16 Bout: 133 | Fall 1:57

-N3-Ivan Chee GAN-----+  
(Sr) 24- 13 Bout: 42 | -S2-Weston Depper SAH-----+  
-S2-Weston Depper SAH-----+  
(Jr) 23- 8 Bout: 291 | Forf

-N2-Kevin Nez GRH-----+  
(Sr) 42- 13 Bout: 43 | -N2-Kevin Nez GRH-----+  
-S3-Ryan Asenjo FL-----+  
(So) 10- 22 Bout: 134 | Fall 1:30

-E4-Preston Waters ROU-----+  
(Sr) 27- 9 Bout: 44 | -W1-Jerrad Trulson FH-----+  
-W1-Jerrad Trulson FH-----+  
(Sr) 47- 2 Bout: 388 | M-Dec 1-10

-N1-Chee BiNali MV-----+  
(Sr) 40- 1 Bout: 45 | -N1-Chee BiNali MV-----+  
-S4-TJ Chase EM-----+  
(Fr) 14- 12 Bout: 135 | Fall :37

-E3-Lee Ellsworth SHO-----+  
(Sr) 36- 9 Bout: 46 | -E3-Lee Ellsworth SHO-----+  
-W2-Billy Ogello WKB-----+  
28- 14 Bout: 292 | Fall 1:34

-E2-Carlos Barela HBK-----+  
(So) 15- 8 Bout: 47 | -E2-Carlos Barela HBK-----+  
-W3-Matt DalCerro CV-----+  
26- 22 Bout: 136 | Fall 1:22

-N4-Matthew Shirly TC-----+  
(Jr) 36- 11 Bout: 48 | -S1-Erik Dominguez SAF-----+  
-S1-Erik Dominguez SAF-----+  
(Jr) 33- 5 Bout: 347 | Fall 1:11

-W4-Roberto Gregorio EF-----+  
Bout: 189 | -W4-Roberto Gregorio EF-----+  
-N3-Ivan Chee GAN-----+  
Forf Bout: 245 | -E2-Carlos Barela HBK-----+  
-E2-Carlos Barela HBK-----+  
M-Dec 1-10 Bout: 319

-S3-Ryan Asenjo FL-----+  
Bout: 190 | -E4-Preston Waters ROU-----+  
-E4-Preston Waters ROU-----+  
Fall 1:37 Bout: 246 | -E3-Lee Ellsworth SHO-----+  
-E3-Lee Ellsworth SHO-----+  
M-Dec 5-13

-S4-TJ Chase EM-----+  
Bout: 191 | -W2-Billy Ogello WKB-----+  
-W2-Billy Ogello WKB-----+  
Fall :51 Bout: 247 | -N2-Kevin Nez GRH-----+  
-N2-Kevin Nez GRH-----+  
Dec 0-7 Bout: 320

-W3-Matt DalCerro CV-----+  
Bout: 192 | -N4-Matthew Shirly TC-----+  
-N4-Matthew Shirly TC-----+  
Fall :33 Bout: 248 | -N4-Matthew Shirly TC-----+  
-S2-Weston Depper SAH-----+  
Dec 8-3

-W1-Jerrad Trulson FH-----+  
Bout: 347 | -W1-Jerrad Trulson FH-----+  
Fall 1:49

-E2-Carlos Barela HBK-----+  
Dec 13-7

Bout: 387 | -W1-Jerrad Trulson FH-----+  
3rd Place  
Dec 8-2

-N2-Kevin Nez GRH-----+  
Fall 4:53

Bout: 348 | -N2-Kevin Nez GRH-----+  
Dflt INJURY

-S1-Erik Dominguez SAF-----+  
Bout: 386 | -E2-Carlos Barela HBK-----+  
-E2-Carlos Barela HBK-----+  
Bout: 386 | -E2-Carlos Barela HBK-----+  
-S1-Erik Dominguez SAF-----+  
-S1-Erik Dominguez SAF-----+  
Dflt INJURY

- Place Winners -  
1st E1-Lee Perez PAY (Sr) 43- 5  
2nd N1-Chee BiNali MV (Sr) 43- 2  
3rd W1-Jerrad Trulson FH (Sr) 51- 3  
4th N2-Kevin Nez GRH (Sr) 46- 15

- Place Winners -  
5th E2-Carlos Barela HBK (So) 19- 10  
6th S1-Erik Dominguez SAF (Jr) 35- 8

Weight: 140

-W1-Chris Merwin CV-----+  
(Sr) 44- 8 Bout: 49 | -W1-Chris Merwin CV-----+  
-S4-Tyler Romack EM-----+  
(Fr) 11- 14 Bout: 137 | Forf

-E3-Billy Rova BR-----+  
(Jr) 37- 6 Bout: 50 | -E3-Billy Rova BR-----+  
-N2-Ty Sells MV-----+  
(Fr) 37- 15 T-Fall 17-1

-E2-Levi Butler SHO-----+  
(Sr) 31- 17 Bout: 51 | -E2-Levi Butler SHO-----+  
-N3-Orlando Yazzie TC-----+  
(Sr) 23- 17 Bout: 138 | T-Fall 18-2

-W4-Christian Rodriguez EF-----+  
(Sr) 18- 26 Bout: 52 | -S1-Nick Piedmont SAH-----+  
-S1-Nick Piedmont SAH-----+  
(Jr) 39- 2 Fall 5:46

-E1-Porter Wilbanks PAY-----+  
(Jr) 39- 5 Bout: 53 | -E1-Porter Wilbanks PAY-----+  
-N4-Charles Austin HP-----+  
(Sr) 17- 10 Bout: 139 | Forf

-W3-Mick Maya PK-----+  
(Jr) 48- 15 Bout: 54 | -S2-Patrick Sullivan STN-----+  
-S2-Patrick Sullivan STN-----+  
(Jr) 20- 10 Dec 4-9

-W2-Josh Trulson FH-----+  
(So) 31- 12 Bout: 55 | -S3-Palmer Bingham SAF-----+  
-S3-Palmer Bingham SAF-----+  
(So) 26- 13 Bout: 140 | Forf

-E4-Frank Villa AL-----+  
(So) 18- 12 Bout: 56 | -N1-Daniel Bailon WSL-----+  
-N1-Daniel Bailon WSL-----+  
(Sr) 30- 8 Dec 5-9

-S4-Tyler Romack EM-----+  
Bout: 193 | -N2-Ty Sells MV-----+  
-N2-Ty Sells MV-----+  
Forf Bout: 249 | -N2-Ty Sells MV-----+  
-N1-Daniel Bailon WSL-----+  
Dflt INJURY

-N3-Orlando Yazzie TC-----+  
Bout: 194 | -N3-Orlando Yazzie TC-----+  
-W4-Christian Rodriguez EF-----+  
Fall 3:51 Bout: 250 | -S2-Patrick Sullivan STN-----+  
-S2-Patrick Sullivan STN-----+  
Fall 3:09

-E3-Billy Rova BR-----+  
Dec 3-4

Bout: 293 | -E3-Billy Rova BR-----+  
Dec 5-7

-S1-Nick Piedmont SAH-----+  
M-Dec 0-11

Bout: 392 | -E1-Porter Wilbanks PAY-----+  
Champion  
Dec 3-8

-E1-Porter Wilbanks PAY-----+  
T-Fall 17-1

Bout: 294 | -E1-Porter Wilbanks PAY-----+  
T-Fall 18-3

-S3-Palmer Bingham SAF-----+  
Dflt INJURY

-S1-Nick Piedmont SAH-----+  
Bout: 349 | -S1-Nick Piedmont SAH-----+  
Dec 7-1

-N2-Ty Sells MV-----+  
Bout: 321 | -S2-Patrick Sullivan STN-----+  
M-Dec 10-19





(Fr) 27- 1 Bout: 70 | -N3-Victor Martinez WSL-----+  
 -W2-AJ Hoyt WKB-----+ Dflit  
 (So) 6- 4 Bout: 298  
 -N2-Ricardo Harvey WR-----+ | -S1-Justin Gaethje SAF-----+  
 (Fr) 19- 4 Bout: 71 | -N2-Ricardo Harvey WR-----+ Dec 2-9  
 -W3-Danny Blauser EF-----+ M-Dec 18-7  
 (Jr) 19- 23 Bout: 148 | -S1-Justin Gaethje SAF-----+  
 -E4-Alex Buck ROU-----+ Fall 1:20  
 (So) 30- 8 Bout: 72 | -S1-Justin Gaethje SAF-----+  
 -S1-Justin Gaethje SAF-----+ Fall 1:45  
 (Jr) 42- 2  
 -W4-Josh Honaker RIV-----+ | -N1-Alex Tsosie GAN-----+  
 Bout: 201 | -E3-Terel Nichols SFK-----+ Bout: 353  
 -E3-Terel Nichols SFK-----+ Fall 2:19 Bout: 257 | -N2-Ricardo Harvey WR-----+ | -N1-Alex Tsosie GAN-----+  
 -N2-Ricardo Harvey WR-----+ Dec 9-12 Dec 7-4  
 Bout: 325 | -N3-Victor Martinez WSL-----+ Bout: 399  
 -S3-Matthew Cruz GL-----+ | -N4-Neil Wagner CHN-----+ | -E1-Sean Holladay SHO-----+  
 Bout: 202 | -N4-Neil Wagner CHN-----+ Dec 7-11 Bout: 258 | -N3-Victor Martinez WSL-----+ 3rd Place  
 -N4-Neil Wagner CHN-----+ -N3-Victor Martinez WSL-----+ Fall 4:24 Dec 5-10  
 Bout: 203 | -W2-AJ Hoyt WKB-----+ | -W1-Jeff Cappellini FH-----+  
 -W2-AJ Hoyt WKB-----+ Fall :48 Bout: 259 | -W1-Jeff Cappellini FH-----+ T-Fall 0-16  
 -W3-Danny Blauser EF-----+ | -W1-Jeff Cappellini FH-----+ Bout: 326  
 (Jr) 19- 23 Bout: 204 | -E4-Alex Buck ROU-----+ | -W1-Jeff Cappellini FH-----+ M-Dec 13-2  
 -E4-Alex Buck ROU-----+ Dec 6-13 Bout: 260 | -E4-Alex Buck ROU-----+ Bout: 354 | -E1-Sean Holladay SHO-----+  
 -S2-Nick Weame SAH-----+ | -E1-Sean Holladay SHO-----+ M-Dec 9-0 Fall 1:55  
 -E1-Sean Holladay SHO-----+ Bout: 398 | -W1-Jeff Cappellini FH-----+  
 -W1-Jeff Cappellini FH-----+ 5th Place  
 M-Dec 2-16

- Place Winners -  
 1st S1-Justin Gaethje SAF (Jr) 46- 2  
 2nd E2-David Cluff PAY (Sr) 38- 6  
 3rd E1-Sean Holladay SHO (Sr) 48- 5  
 4th N1-Alex Tsosie GAN (So) 25- 18

- Place Winners -  
 5th W1-Jeff Cappellini FH (Jr) 46- 9  
 6th N3-Victor Martinez WSL (Fr) 30- 4

Weight: 160

-S1-Andrew Ashford CO-----+  
 46- 4 Bout: 73 | -S1-Andrew Ashford CO-----+  
 -W4-Phillip Anderelli FH-----+ Dec 5-3  
 (Jr) 24- 24 Bout: 149  
 -N3-Myron Brady MV-----+ | -S1-Andrew Ashford CO-----+  
 (Jr) 31- 5 Bout: 74 | -E2-Ross Fackler ROU-----+ Fall 4:42  
 -E2-Ross Fackler ROU-----+ Dec 6-13 Bout: 299  
 -N2-Kirk Tsosie GRH-----+ | -S1-Andrew Ashford CO-----+  
 (Sr) 15- 6 Bout: 75 | -E3-Zach Rogers PAY-----+ Fall 3:57  
 -E3-Zach Rogers PAY-----+ M-Dec 4-15 Bout: 404  
 (Jr) 16- 21 Bout: 150 | -E3-Zach Rogers PAY-----+ Dec 11-6  
 -S4-Robelio Chavez SCZ-----+ | -W1-Sean DalCerro CV-----+  
 (Jr) 18- 13 Bout: 76 | -W1-Sean DalCerro CV-----+ Dec 4-6  
 -W1-Sean DalCerro CV-----+ (Sr) 38- 6  
 -N1-John Gonzales WSL-----+ | -N1-John Gonzales WSL-----+  
 (So) 37- 6 Bout: 77 | -N1-John Gonzales WSL-----+ Fall 5:50  
 -E4-Isaiah Hadley HBK-----+ Bout: 151  
 (Sr) 11- 10 | -S3-Billy Juarado SAF-----+  
 -S3-Billy Juarado SAF-----+ M-Dec 0-8 Bout: 300  
 (Jr) 41- 6 Bout: 78 | -S3-Billy Juarado SAF-----+ Dec 6-5  
 -W2-Ben Preslar EF-----+ | -S3-Billy Juarado SAF-----+  
 (Jr) 32- 14 | -S3-Billy Juarado SAF-----+ Dec 6-5  
 -S2-Kyle Day SAH-----+ | -S2-Kyle Day SAH-----+  
 (Sr) 30- 5 Bout: 79 | -S2-Kyle Day SAH-----+ T-Fall 16-0  
 -W3-Billy Lucas PK-----+ | -E1-AJ Bales SHO-----+  
 (Sr) 24- 19 Bout: 152 | -E1-AJ Bales SHO-----+ Dec 6-7  
 -N4-Jacob Keah-Tigh WR-----+ | -E1-AJ Bales SHO-----+  
 (Fr) 12- 14 Bout: 80 | -E1-AJ Bales SHO-----+ Fall :50  
 -E1-AJ Bales SHO-----+ (Jr) 45- 4  
 -W4-Phillip Anderelli FH-----+ | -E3-Zach Rogers PAY-----+  
 Bout: 205 | -N3-Myron Brady MV-----+ Bout: 355  
 -N3-Myron Brady MV-----+ Dec 9-12 Bout: 261 | -S2-Kyle Day SAH-----+ Dec 4-7  
 -S2-Kyle Day SAH-----+ T-Fall 0-16  
 Bout: 327 | -S2-Kyle Day SAH-----+ Dec 6-5  
 -N2-Kirk Tsosie GRH-----+ | -S4-Robelio Chavez SCZ-----+  
 Bout: 206 | -S4-Robelio Chavez SCZ-----+ M-Dec 8-16 Bout: 262 | -N1-John Gonzales WSL-----+  
 -S4-Robelio Chavez SCZ-----+ | -N1-John Gonzales WSL-----+ Fall 2:15  
 -E4-Isaiah Hadley HBK-----+ | -E4-Isaiah Hadley HBK-----+  
 Bout: 207 | -E4-Isaiah Hadley HBK-----+ Dec 7-2 Bout: 263 | -W1-Sean DalCerro CV-----+  
 -W2-Ben Preslar EF-----+ | -W1-Sean DalCerro CV-----+ M-Dec 7-19  
 (Jr) 32- 14 | -W1-Sean DalCerro CV-----+ Bout: 328  
 -W3-Billy Lucas PK-----+ | -W3-Billy Lucas PK-----+  
 Bout: 208 | -W3-Billy Lucas PK-----+ Dec 8-2 Bout: 264 | -E2-Ross Fackler ROU-----+  
 -N4-Jacob Keah-Tigh WR-----+ | -E2-Ross Fackler ROU-----+ Fall 2:46  
 -E2-Ross Fackler ROU-----+ Bout: 356  
 -E2-Ross Fackler ROU-----+ | -E1-AJ Bales SHO-----+  
 -E1-AJ Bales SHO-----+ Dec 1-3  
 Bout: 402 | -E2-Ross Fackler ROU-----+  
 -E2-Ross Fackler ROU-----+ 5th Place  
 Dec 4-8

- Place Winners -  
 1st S3-Billy Juarado SAF (Jr) 45- 6  
 2nd S1-Andrew Ashford CO (Sr) 49- 5  
 3rd E1-AJ Bales SHO (Jr) 49- 5  
 4th S2-Kyle Day SAH (Sr) 34- 7

- Place Winners -  
 5th E2-Ross Fackler ROU (Sr) 31- 9  
 6th E3-Zach Rogers PAY (Jr) 18- 24

Weight: 171

-N1-Derrick Sullivan GRH-----+

(Sr) 39- 7 Bout: 81   -N1-Derrick Sullivan GRH-----+ -W4-Chaz Antos WKB-----+ (Fr) 4- 19 Bout: 153 -E3-Troy Jenkins PAY-----+ (Sr) 31- 21 Bout: 82   -S2-John Paul Perales SCZ-----+ -S2-John Paul Perales SCZ-----+ (So) 26- 10 Bout: 301 -E2-Garet Flake SFK-----+ (Sr) 22- 12 Bout: 83   -E2-Garet Flake SFK-----+ -S3-Jason Newton CO-----+ (Sr) 36- 13 Bout: 154 -N4-Corderick Glasses MV-----+ (Jr) 16- 18 Bout: 84   -W1-Nick Uden PK-----+ -W1-Nick Uden PK-----+ (Sr) 31- 9 Bout: 408 -E1-Charlie Ryan SHO-----+ (Sr) 33- 2 Bout: 85   -E1-Charlie Ryan SHO-----+ -S4-Josh Noble SAH-----+ (So) 11- 14 Bout: 155 -N3-Monty Bitloy WR-----+ (Fr) 2- 1 Bout: 86   -N3-Monty Bitloy WR-----+ -W2-Anthony Carrillo FH-----+ (So) 26- 19 Bout: 302 -N2-Gjermundson Teller TC-----+ (Jr) 34- 10 Bout: 87   -N2-Gjermundson Teller TC-----+ -W3-William Bowen CV-----+ 19- 20 Bout: 156 -E4-Frank Larzelere AL-----+ (Fr) 28- 18 Bout: 88   -S1-Manny Jurado SAF-----+ -S1-Manny Jurado SAF-----+ (Jr) 40- 10 Bout: 209 -W4-Chaz Antos WKB-----+ Bout: 209   -E3-Troy Jenkins PAY-----+ -E3-Troy Jenkins PAY-----+ Fall 1:25 Bout: 265   -N2-Gjermundson Teller TC-----+ -N2-Gjermundson Teller TC-----+ Bout: 329 -S3-Jason Newton CO-----+ Bout: 210   -S3-Jason Newton CO-----+ -N4-Corderick Glasses MV-----+ Dec 5-3 Bout: 266   -S3-Jason Newton CO-----+ -N3-Monty Bitloy WR-----+ Fall 4:54 -S4-Josh Noble SAH-----+ Bout: 211   -W2-Anthony Carrillo FH-----+ -W2-Anthony Carrillo FH-----+ Fall 1:51 Bout: 267   -W1-Nick Uden PK-----+ -W1-Nick Uden PK-----+ Fall :57 Bout: 330 -W3-William Bowen CV-----+ Bout: 212   -E4-Frank Larzelere AL-----+ -E4-Frank Larzelere AL-----+ Fall 1:38 Bout: 268   -S2-John Paul Perales SCZ-----+ -S2-John Paul Perales SCZ-----+ M-Dec 5-14 -E1-Charlie Ryan SHO-----+ Bout: 358   -E1-Charlie Ryan SHO-----+ -N2-Gjermundson Teller TC-----+ Bout: 406   -W1-Nick Uden PK-----+ -W1-Nick Uden PK-----+ 5th Place Fall :43 - Place Winners - 1st S1-Manny Jurado SAF (Jr) 44- 10 2nd E2-Garet Flake SFK (Sr) 25- 13 3rd E1-Charlie Ryan SHO (Sr) 37- 3 4th N1-Derrick Sullivan GRH (Sr) 42- 9	-N1-Derrick Sullivan GRH-----+ Dec 9-8 -E2-Garet Flake SFK-----+ T-Fall 0-17 -E2-Garet Flake SFK-----+ Fall 3:06 -E2-Garet Flake SFK-----+ Bout: 408 -S1-Manny Jurado SAF-----+ Champion Dec 6-8 -S1-Manny Jurado SAF-----+ Dec 4-6 -S1-Manny Jurado SAF-----+ M-Dec 4-12 -N1-Derrick Sullivan GRH-----+ Bout: 357 -N1-Derrick Sullivan GRH-----+ Fall 4:39 -N2-Gjermundson Teller TC-----+ Dec 7-5 -S3-Jason Newton CO-----+ Fall 4:54 -E1-Charlie Ryan SHO-----+ 3rd Place Fall 2:17 -E1-Charlie Ryan SHO-----+ Dec 8-10 -N2-Gjermundson Teller TC-----+ Bout: 407 -W1-Nick Uden PK-----+ Dec 6-2 -E1-Charlie Ryan SHO-----+ Dec 8-10 -W1-Nick Uden PK-----+ 5th Place Fall :43 - Place Winners - 5th W1-Nick Uden PK (Sr) 35- 11 6th N2-Gjermundson Teller TC (Jr) 37- 13
---------------------------------------------------------------------------------------------------------------------------------------------------------------------------------------------------------------------------------------------------------------------------------------------------------------------------------------------------------------------------------------------------------------------------------------------------------------------------------------------------------------------------------------------------------------------------------------------------------------------------------------------------------------------------------------------------------------------------------------------------------------------------------------------------------------------------------------------------------------------------------------------------------------------------------------------------------------------------------------------------------------------------------------------------------------------------------------------------------------------------------------------------------------------------------------------------------------------------------------------------------------------------------------------------------------------------------------------------------------------------------------------------------------------------------------------------------------------------------------------------------------------------------------------------------------------------------------------------------------------------------------------------------------------------------------------------------------------------------------------------------------------------------------------------------------------------------------------------------------------------------------------------------------------------------------------------------------------------------------------------------------------------------------------------------------------------------------------------------------------------------------------------------------------------------------------------------------------------------------------------------------------------------------------------------------------------------------------------------	---------------------------------------------------------------------------------------------------------------------------------------------------------------------------------------------------------------------------------------------------------------------------------------------------------------------------------------------------------------------------------------------------------------------------------------------------------------------------------------------------------------------------------------------------------------------------------------------------------------------------------------------------------------------------------------------------------------------------------------------------------------------------------------------------------------------------------------------------------------------------------------------------

Weight: 189

-W1-Joey Venegas PK-----+ (Sr) 39- 10 Bout: 89   -W1-Joey Venegas PK-----+ -N4-Dalvin Gorman GAN-----+ (So) 8- 16 Bout: 157 -E3-Cody Stinnett SFK-----+ (Sr) 16- 17 Bout: 90   -S2-Michael Guerrero SCZ-----+ -S2-Michael Guerrero SCZ-----+ 33- 2 T-Fall 0-16 Bout: 303 -E2-Josh Stump HBK-----+ (Jr) 23- 14 Bout: 91   -S3-Steven Hernandez SAF-----+ -S3-Steven Hernandez SAF-----+ (Jr) 25- 15 Bout: 158 -W4-Kyle Gray CV-----+ 9- 19 Bout: 92   -N1-Joe Larsen WSL-----+ -N1-Joe Larsen WSL-----+ (So) 28- 10 Fall 1:57 Bout: 412 -E1-Steele Armstrong PAY-----+ (Fr) 44- 9 Bout: 93   -E1-Steele Armstrong PAY-----+ -S4-John Garcia FL-----+ 21- 12 Bout: 159 -E1-Steele Armstrong PAY-----+ M-Dec 14-2 -W3-Adam Swanson FH-----+ (Sr) 20- 11 Bout: 94   -W3-Adam Swanson FH-----+ -N2-Seth Little TC-----+ (Sr) 27- 16 Bout: 304 -S1-Julius Blair CO-----+ Dec 6-10 -W2-Tyler Best EF-----+ (Sr) 28- 17 Bout: 95   -N3-Skylan Fowler GRH-----+ -N3-Skylan Fowler GRH-----+ (Jr) 36- 17 Bout: 160 -S1-Julius Blair CO-----+ Fall 1:33 -E4-Ray Hamblin ROU-----+ (Jr) 25- 16 Bout: 96   -S1-Julius Blair CO-----+ -S1-Julius Blair CO-----+ (Sr) 60- 3 M-Dec 3-16 -N4-Dalvin Gorman GAN-----+ Bout: 213   -E3-Cody Stinnett SFK-----+ -E3-Cody Stinnett SFK-----+ Fall :37 Bout: 269   -N3-Skylan Fowler GRH-----+ -N3-Skylan Fowler GRH-----+ Bout: 331 -E2-Josh Stump HBK-----+ Bout: 214   -E2-Josh Stump HBK-----+ -W4-Kyle Gray CV-----+ Fall 1:44 Bout: 270   -E2-Josh Stump HBK-----+ -W3-Adam Swanson FH-----+ M-Dec 11-2 -S4-John Garcia FL-----+ Bout: 215   -S4-John Garcia FL-----+ -N2-Seth Little TC-----+ Fall 3:30 Bout: 271   -S4-John Garcia FL-----+ -N1-Joe Larsen WSL-----+ Dec 7-2 Bout: 332 -W2-Tyler Best EF-----+ Bout: 216   -E4-Ray Hamblin ROU-----+ -E4-Ray Hamblin ROU-----+ Fall 3:23 Bout: 272   -W1-Joey Venegas PK-----+ -W1-Joey Venegas PK-----+ Fall 1:42 Bout: 360 -E1-Steele Armstrong PAY-----+ M-Dec 0-8	-S2-Michael Guerrero SCZ-----+ Fall 3:02 -S2-Michael Guerrero SCZ-----+ M-Dec 14-2 -S3-Steven Hernandez SAF-----+ M-Dec 11-2 -S2-Michael Guerrero SCZ-----+ Bout: 412 -S2-Michael Guerrero SCZ-----+ Champion Dec 12-8 -E1-Steele Armstrong PAY-----+ M-Dec 14-2 -S1-Julius Blair CO-----+ Dec 6-10 -S3-Steven Hernandez SAF-----+ Bout: 359 -S3-Steven Hernandez SAF-----+ Fall 4:30 -N3-Skylan Fowler GRH-----+ Bout: 331 -N3-Skylan Fowler GRH-----+ M-Dec 16-4 -E2-Josh Stump HBK-----+ Bout: 214 -E2-Josh Stump HBK-----+ M-Dec 11-2 -S4-John Garcia FL-----+ Bout: 215 -S4-John Garcia FL-----+ Dec 7-2 -W1-Joey Venegas PK-----+ M-Dec 8-11 -E1-Steele Armstrong PAY-----+ M-Dec 0-8	-E1-Steele Armstrong PAY-----+ 3rd Place Fall 2:35 -E1-Steele Armstrong PAY-----+ 3rd Place Fall 2:35
------------------------------------------------------------------------------------------------------------------------------------------------------------------------------------------------------------------------------------------------------------------------------------------------------------------------------------------------------------------------------------------------------------------------------------------------------------------------------------------------------------------------------------------------------------------------------------------------------------------------------------------------------------------------------------------------------------------------------------------------------------------------------------------------------------------------------------------------------------------------------------------------------------------------------------------------------------------------------------------------------------------------------------------------------------------------------------------------------------------------------------------------------------------------------------------------------------------------------------------------------------------------------------------------------------------------------------------------------------------------------------------------------------------------------------------------------------------------------------------------------------------------------------------------------------------------------------------------------------------------------------------------------------------------------------------------------------------------------------------------------------------------------------------------------------------------------------------------------------------------------------------------------------------------------------------------------------------------------------------------------------------------------------------------------------------------------------------------------------------------------------------------------	---------------------------------------------------------------------------------------------------------------------------------------------------------------------------------------------------------------------------------------------------------------------------------------------------------------------------------------------------------------------------------------------------------------------------------------------------------------------------------------------------------------------------------------------------------------------------------------------------------------------------------------------------------------------------------------------------------------------------------------------------------------------------------------------------	----------------------------------------------------------------------------------------------------------------------

```

-N3-Skylan Fowler GRH-----+
      Bout: 410 | -W1-Joey Venegas PK-----+
- W1-Joey Venegas PK-----+       5th Place
                               |       Fall 2:07
- Place Winners -
5th W1-Joey Venegas PK      (Sr) 43- 12
6th N3-Skylan Fowler GRH   (Jr) 39- 20
    
```

```

- Place Winners -
1st S2-Michael Guerrero SCZ      37- 2
2nd S1-Julius Blair CO           (Sr) 63- 4
3rd E1-Steele Armstrong PAY      (Fr) 48- 10
4th S3-Steven Hernandez SAF      (Jr) 28- 17
    
```

Weight: 215

```

-N1-Justin Powell WSL-----+
(Jr) 42- 2 Bout: 97 | -N1-Justin Powell WSL-----+
- W4-Alonso Perez PK-----+       Fall 3:51
      (So) 39- 11      |       Bout: 161
- S3-Louis Garcia FL-----+
      21- 12 Bout: 98 | -E2-Jeff Baldonado BR-----+
- E2-Jeff Baldonado BR-----+       Fall 3:29
      (Jr) 41- 7      |
- S2-Bryce Nichols SAH-----+
      (Sr) 28- 8 Bout: 99 | -S2-Bryce Nichols SAH-----+
- E3-Ross Eager ROU-----+       Fall 1:13
      (Jr) 23- 19      |       Bout: 162
- N4-Uriah Yellowhorse TC-----+
      (Jr) 23- 9 Bout: 100 | -W1-HP Rollins FH-----+
- W1-HP Rollins FH-----+       Fall 1:50
      (Sr) 43- 4      |
- S1-Francisco Leon SAF-----+
      (Jr) 42- 6 Bout: 101 | -S1-Francisco Leon SAF-----+
- E4-Nick Alexander PAY-----+       Fall 4:35
      (So) 3- 3      |       Bout: 163
- N3-Adrian Jim CHN-----+
      (So) 15- 11 Bout: 102 | -W2-Kevin Wilkinson EF-----+
- W2-Kevin Wilkinson EF-----+       Fall 1:32
      (Sr) 42- 7      |
- N2-Corey Attson GAN-----+
      (Sr) 21- 9 Bout: 103 | -W3-Devin Johnson RIV-----+
- W3-Devin Johnson RIV-----+       Fall 1:16
      (Sr) 24- 3      |       Bout: 164
- S4-Terry Boyle STN-----+
      (Sr) 1- 13 Bout: 104 | -E1-Tyrell Sulu HBK-----+
- E1-Tyrell Sulu HBK-----+       T-Fall 3-18
      (Fr) 30- 7      |
- W4-Alonso Perez PK-----+
      Bout: 217      | -W4-Alonso Perez PK-----+
- S3-Louis Garcia FL-----+       Fall 2:56 Bout: 273 | -W3-Devin Johnson RIV-----+
      Bout: 218      |       Bout: 333
- N4-Uriah Yellowhorse TC-----+
      Bout: 218      | -N4-Uriah Yellowhorse TC-----+
- E4-Nick Alexander PAY-----+       Fall 1:54 Bout: 274 | -S1-Francisco Leon SAF-----+
      Bout: 219      |       Bout: 274
- N3-Adrian Jim CHN-----+
      Bout: 219      | -N3-Adrian Jim CHN-----+
- N3-Adrian Jim CHN-----+       Fall 1:56 Bout: 275 | -S2-Bryce Nichols SAH-----+
      Bout: 275      |       Bout: 334
- N2-Corey Attson GAN-----+
      Bout: 220      | -N2-Corey Attson GAN-----+
- S4-Terry Boyle STN-----+       Fall 3:18 Bout: 276 | -E2-Jeff Baldonado BR-----+
      Bout: 220      |       Bout: 276
- E2-Jeff Baldonado BR-----+
      Bout: 220      | -E2-Jeff Baldonado BR-----+
- E2-Jeff Baldonado BR-----+
      Bout: 220      |
- Place Winners -
1st W2-Kevin Wilkinson EF      (Sr) 46- 7
2nd W1-HP Rollins FH          (Sr) 46- 5
3rd N1-Justin Powell WSL      (Jr) 46- 3
4th E1-Tyrell Sulu HBK       (Fr) 33- 9
    
```

Weight: 275

```

-S1-Justin Felix SAF-----+
(Jr) 46- 6 Bout: 105 | -S1-Justin Felix SAF-----+
- W4-Mick Harmon RIV-----+       Fall :42
      (So) 0- 0      |       Bout: 165
- E3-Dwight Boyd BR-----+
      (So) 30- 12 Bout: 106 | -N2-David Young WSL-----+
- N2-David Young WSL-----+       Dec 5-3
      (Jr) 29- 9      |
- E2-Josh Curtis ROU-----+
      (Jr) 32- 17 Bout: 107 | -E2-Josh Curtis ROU-----+
- N3-Vince Jim GRH-----+       Fall 1:45
      (Jr) 13- 12      |       Bout: 166
- S4-Corey Noble SAH-----+
      (So) 10- 10 Bout: 108 | -W1-Brian Postma PK-----+
- W1-Brian Postma PK-----+       Fall :41
      (Sr) 58- 2      |
- E1-Oscar Chavez PAY-----+
      (Jr) 17- 10 Bout: 109 | -E1-Oscar Chavez PAY-----+
- N4-Joshua Hosnic MV-----+       Fall 4:50
      (Fr) 9- 24      |       Bout: 167
- S3-Josh Stricklin FL-----+
      28- 19 Bout: 110 | -W2-Aaron Heck EF-----+
- W2-Aaron Heck EF-----+       Fall 1:07
      (Jr) 36- 6      |
- S2-William McKaney SCZ-----+
      (Jr) 31- 4 Bout: 111 | -S2-William McKaney SCZ-----+
- W3-Edgar Verdugo FH-----+       M-Dec 11-2
      (Sr) 29- 9      |       Bout: 168
- E4-Jimmy Leech SHO-----+
      (Jr) 8- 13 Bout: 112 | -N1-Nick Wagner CHN-----+
- N1-Nick Wagner CHN-----+       Fall 1:35
      (Jr) 21- 3      |
- Place Winners -
5th E2-Jeff Baldonado BR      (Jr) 45- 9
6th W3-Devin Johnson RIV     (Sr) 27- 6
    
```

### Brackets

-W4-Mick Harmon RIV-----+ Bout: 221   -E3-Dwight Boyd BR-----+ -E3-Dwight Boyd BR-----+   M-Dec 2-15 Bout: 277   -S2-William McKaney SCZ-----+ -S2-William McKaney SCZ-----+ Bout: 335   -S1-Justin Felix SAF-----+ Bout: 363   -S1-Justin Felix SAF-----+ Dec 3-1		
-N3-Vince Jim GRH-----+ Bout: 222   -S4-Corey Noble SAH-----+ -S4-Corey Noble SAH-----+   Fall 1:47 Bout: 278   -E1-Oscar Chavez PAY-----+ -E1-Oscar Chavez PAY-----+ Fall 1:27		
-N4-Joshua Hoshnic MV-----+ Bout: 223   -S3-Josh Stricklin FL-----+ -S3-Josh Stricklin FL-----+   Fall 1:32 Bout: 279   -S3-Josh Stricklin FL-----+ -E2-Josh Curtis ROU-----+ Dec 5-2 Bout: 336   -N2-David Young WSL-----+ Fall 2:19		-S1-Justin Felix SAF-----+ Bout: 419   -S1-Justin Felix SAF-----+ 3rd Place Fall 1:27
-W3-Edgar Verdugo FH-----+ Bout: 224   -W3-Edgar Verdugo FH-----+ -E4-Jimmy Leech SHO-----+   Fall 3:28 Bout: 280   -N2-David Young WSL-----+ -N2-David Young WSL-----+ Fall		-N1-Nick Wagner CHN-----+ Fall 3:34
	-N1-Nick Wagner CHN-----+ Bout: 364   -N1-Nick Wagner CHN-----+ Fall 3:34	
	-S2-William McKaney SCZ-----+ Bout: 418   -N2-David Young WSL-----+ -N2-David Young WSL-----+ 5th Place Dec 3-6	
- Place Winners -	(Sr) 62- 2	- Place Winners -
1st W1-Brian Postma PK	(Jr) 39- 7	5th N2-David Young WSL
2nd W2-Aaron Heck EF	(Jr) 50- 7	6th S2-William McKaney SCZ
3rd S1-Justin Felix SAF	(Jr) 24- 5	
4th N1-Nick Wagner CHN		

**Preferred Educational Software**

9585 Woodgate Lane

Byron IL 61010

Phone: (888) 959-2016

e-mail: [cotterk@pes-sports.com](mailto:cotterk@pes-sports.com)

(c) 2001 - All rights reserved

## 2005-2006 4A Div. I State Wrestling Tournament

Place	School	Points	Place	School	Points
1	Thunderbird	194.5	28	Chaparral	1
2	Moon Valley	148.5	29	R.S.Kellis	0
3	Pueblo	135	29	0	0
4	Ironwood Rdg.	106	29	0	0
5	Independence	93	29	0	0
6	Marana	88	29	0	0
7	Prescott	73	29	0	0
8	Lake Havasu	69	29	0	0
9	Nogales	67	29	0	0
10	Greenway	55.5	29	0	0
11	Agua Fria	55	29	0	0
12	Amphi	54.5	29	0	0
13	Catalina Foot.	52	29	0	0
14	Canyon del Oro	51	29	0	0
15	Cienega	50.5	29	0	0
16	Millennium	49	29	0	0
17	Sahuaro	48	29	0	0
18	Pinnacle	46	29	0	0
19	McClintock	45	29	0	0
20	Saguaro	34	29	0	0
21	Catalina	29.5	29	0	0
22	Apollo	26	29	0	0
23	Copper Canyon	23	29	0	0
24	Sabino	20	29	0	0
25	Willow Canyon	15	29	0	0
26	Cactus	13	29	0	0
27	Rincon	11			

## 2005-2006 4A Div. I State Wrestling Tournament

<b>WT 103</b>	<b>YR</b>	<b>NAME</b>	<b>SCHOOL</b>	<b>W - L</b>	<b>Fall</b>	<b>Score</b>	<b>WT 145</b>	<b>YR</b>	<b>NAME</b>	<b>SCHOOL</b>	<b>W - L</b>	<b>Fall</b>	<b>Score</b>
<b>Champ</b>	FR	Brandon Horton	Lake Havasu	19 - 3	2:59	-	<b>Champ</b>	So	Jake Peterson	Pinnacle	21 - 2		2 - 1
<b>Second</b>	Fr	Yobel Muchang	Saguaro	21 - 2			<b>Second</b>	So	Adam Torres	Thunderbird	15 - 12		
<b>Third</b>	So	Herman, Brannon	Ironwood Rdg.	31 - 13			<b>Third</b>	Sr	Esparaza, Chris	Marana	45 - 6		
<b>Fourth</b>	So	Hughes, Andrea	Catalina Foot.	30 - 9			<b>Fourth</b>	Jr	Morris, Billy	Catalina Foot.	21 - 6		
<b>Fifth</b>	Fr	Trevor Bradley	McClintock	28 - 11			<b>Fifth</b>	So	Lor, Orson	Amphi	29 - 14		
<b>Sixth</b>	So	Cano, Andy	Canyon Del Oro	24 - 13			<b>Sixth</b>	Jr	Wilton, Garrett	Canyon Del Oro	21 - 9		
<b>WT 112</b>	<b>YR</b>	<b>NAME</b>	<b>SCHOOL</b>	<b>W - L</b>	<b>Fall</b>	<b>Score</b>	<b>WT 152</b>	<b>YR</b>	<b>NAME</b>	<b>SCHOOL</b>	<b>W - L</b>	<b>Fall</b>	<b>Score</b>
<b>Champ</b>	Sr	Matt Long	Moon Valley	34 - 1		7 - 2	<b>Champ</b>	Sr	Barron, Matt	Canyon Del Oro	40 - 4		10 - 4
<b>Second</b>	Sr	Nick Saenz	Thunderbird	28 - 4			<b>Second</b>	Sr	Esparza, Larry	Marana	42 - 8		
<b>Third</b>	Sr	Estillore, Robert	Pueblo	41 - 9			<b>Third</b>	Sr	Garcia, Mathew	Pueblo	38 - 14		
<b>Fourth</b>	Sr	Francisco Alatorre	McClintock	27 - 13			<b>Fourth</b>	Sr	Joey Martin	Prescott	15 - 17		
<b>Fifth</b>	Sr	Villa, Jesus	Nogales	35 - 6			<b>Fifth</b>	Sr	Sanchez, Tony	Nogales	30 - 9		
<b>Sixth</b>	So	Peters, Matt	Ironwood Rdg.	27 - 17			<b>Sixth</b>	Fr	Anthony Moya	Moon Valley	16 - 7		
<b>WT 119</b>	<b>YR</b>	<b>NAME</b>	<b>SCHOOL</b>	<b>W - L</b>	<b>Fall</b>	<b>Score</b>	<b>WT 160</b>	<b>YR</b>	<b>NAME</b>	<b>SCHOOL</b>	<b>W - L</b>	<b>Fall</b>	<b>Score</b>
<b>Champ</b>	Jr	Islas, David	Pueblo	49 - 2		11 - 2	<b>Champ</b>	Sr	Anaya, Dominick	Pueblo	43 - 10		9 - 5
<b>Second</b>	Jr	David Leaphart	Thunderbird	14 - 4			<b>Second</b>	Sr	Reedy, Ben	Ironwood Rdg.	34 - 6		
<b>Third</b>	So	Miles, Adam	Cienega	33 - 9			<b>Third</b>		Brennen Spratte	Lake Havasu	26 - 3		
<b>Fourth</b>		Freddy Torres	Millennium	30 - 8			<b>Fourth</b>	Sr	Eric Manoogian	Moon Valley	15 - 6		
<b>Fifth</b>	Jr	Ashton Lichlyter	Moon Valley	32 - 8			<b>Fifth</b>	Jr	Martinez, Fernando	Nogales	26 - 12		
<b>Sixth</b>	Jr	Linaker, Charlie	Catalina Foot.	8 - 8			<b>Sixth</b>	So	Adam Cherrington	Pinnacle	20 - 13		
<b>WT 125</b>	<b>YR</b>	<b>NAME</b>	<b>SCHOOL</b>	<b>W - L</b>	<b>Fall</b>	<b>Score</b>	<b>WT 171</b>	<b>YR</b>	<b>NAME</b>	<b>SCHOOL</b>	<b>W - L</b>	<b>Fall</b>	<b>Score</b>
<b>Champ</b>	Sr	Steve Aragon	Moon Valley	32 - 2		5 - 4	<b>Champ</b>	So	Diego Bencomo	Independence	34 - 1		18 - 9
<b>Second</b>	Jr	Jeremy Mazon	Prescott	36 - 7			<b>Second</b>	Sr	Comi, Troy	Ironwood Rdg.	32 - 7		
<b>Third</b>	Jr	Zach Mainez	Thunderbird	28 - 4			<b>Third</b>	Sr	Adam Webster	Greenway	16 - 4		
<b>Fourth</b>	Sr	Martinez, Tyler	Amphi	25 - 8			<b>Fourth</b>	Jr	Lopez, Robert	Pueblo	35 - 10		
<b>Fifth</b>	Sr	Gallardo, Jesus	Rincon	36 - 8			<b>Fifth</b>	Jr	Alentado, Vince	Catalina Foot.	18 - 13		
<b>Sixth</b>	So	Vincent Bradley	McClintock	32 - 11			<b>Sixth</b>	Sr	Eric Force	Thunderbird	25 - 10		
<b>WT 130</b>	<b>YR</b>	<b>NAME</b>	<b>SCHOOL</b>	<b>W - L</b>	<b>Fall</b>	<b>Score</b>	<b>WT 189</b>	<b>YR</b>	<b>NAME</b>	<b>SCHOOL</b>	<b>W - L</b>	<b>Fall</b>	<b>Score</b>
<b>Champ</b>	Jr	Jablonski, Mike	Cienega	19 - 4		8 - 7	<b>Champ</b>	Jr	Mack Surrell	Thunderbird	20 - 2		7 - 1
<b>Second</b>	Jr	Ricky Abril	Thunderbird	25 - 5			<b>Second</b>	Sr	Hoover, Ben	Sahuaro	28 - 8		
<b>Third</b>	Sr	Trent Tewers	Moon Valley	28 - 9			<b>Third</b>	Jr	Maestas, Mike	Amphi	34 - 10		
<b>Fourth</b>	So	Josh Hogan	Independence	16 - 6			<b>Fourth</b>	So	Moreno, Michael	Marana	31 - 15		
<b>Fifth</b>		Ronnie King	Lake Havasu	20 - 14			<b>Fifth</b>	Jr	Justin Busto	Greenway	21 - 12		
<b>Sixth</b>		Marquis Mitchell	Agua Fria	39 - 10			<b>Sixth</b>	Jr	Yribe, Mario	Pueblo	32 - 13		
<b>WT 135</b>	<b>YR</b>	<b>NAME</b>	<b>SCHOOL</b>	<b>W - L</b>	<b>Fall</b>	<b>Score</b>	<b>WT 215</b>	<b>YR</b>	<b>NAME</b>	<b>SCHOOL</b>	<b>W - L</b>	<b>Fall</b>	<b>Score</b>
<b>Champ</b>	Sr	Rishpal Saini	Thunderbird	17 - 2		7 - 2	<b>Champ</b>	Sr	Brunson, Lonnie	Sahuaro	36 - 5		7 - 3
<b>Second</b>		Daniel Iribe	Copper Canyon	21 - 3			<b>Second</b>	Jr	Jose Sanchez	Independence	28 - 3		
<b>Third</b>	Jr	Ryan Donaldson	Prescott	31 - 10			<b>Third</b>	Jr	Ian Smith	Thunderbird	12 - 3		
<b>Fourth</b>	Sr	Cameron Vannoy	Moon Valley	21 - 14			<b>Fourth</b>	So	Reichert, Eric	Ironwood Rdg.	17 - 7		
<b>Fifth</b>		David Baldonado	Agua Fria	34 - 10			<b>Fifth</b>	Sr	Santamaria, Jesus	Pueblo	29 - 16		
<b>Sixth</b>	Sr	Brett Whalen	Cactus	21 - 20			<b>Sixth</b>	Sr	Allen, Carlos	Catalina	15 - 8		
<b>WT 140</b>	<b>YR</b>	<b>NAME</b>	<b>SCHOOL</b>	<b>W - L</b>	<b>Fall</b>	<b>Score</b>	<b>WT HWT</b>	<b>YR</b>	<b>NAME</b>	<b>SCHOOL</b>	<b>W - L</b>	<b>Fall</b>	<b>Score</b>
<b>Champ</b>	Sr	Baker, Mitch	Marana	46 - 2	3:32	-	<b>Champ</b>	Sr	J. D. Hanley	Greenway	23 - 17	5:19	-
<b>Second</b>	So	Extract, Steve	Ironwood Rdg.	20 - 12			<b>Second</b>	Sr	Diamond Johnson	Independence	29 - 3		
<b>Third</b>	Jr	James Eastin	Moon Valley	34 - 6			<b>Third</b>		Chris Green	Millennium	29 - 5		
<b>Fourth</b>	Sr	Ryan Parman	Thunderbird	17 - 5			<b>Fourth</b>	Jr	Sobarzo, Marshal	Nogales	30 - 10		
<b>Fifth</b>		Doug Alexander	Agua Fria	22 - 6			<b>Fifth</b>	Sr	Romero, Robert	Amphi	34 - 12		
<b>Sixth</b>	Sr	Khuu, Dan	Catalina	16 - 5			<b>Sixth</b>	Sr	Petty, Mar-Kell	Sabino	33 - 7		

**2006 AIA 4A Division I State Wrestling**

**Weight Class**

**103lb**

1	Yobel Muchang	19	-	1
Fr	Saguaro			
	<b>1</b>			

1	Yobel Muchang	19	-	1
Fr	Saguaro	<b>Fall</b>	<b>Score</b>	
	Bye			

9	Damir Dautobic	1	-	13
Fr	Cactus			
	<b>2</b>			

8	Kevin Davis	12	-	23
0	Millennium	<b>Fall</b>	<b>Score</b>	
		0:39		

5	Tschirhart, Jake	18	-	9
So	Cienega			
	<b>3</b>			

5	Tschirhart, Jake	19	-	9
So	Cienega	<b>Fall</b>	<b>Score</b>	
		1:18		

13	Chris Kelly	8	-	11
So	Moon Valley			
	<b>4</b>			

4	Herman, Brannon	28	-	12
So	Ironwood Rdg.	<b>Fall</b>	<b>Score</b>	
		7		2

3	Robert Cortez	25	-	11
So	Apollo			
	<b>5</b>			

3	Robert Cortez	26	-	11
So	Apollo	<b>Fall</b>	<b>Score</b>	
		0:51		

11	Lopez, Brandon	4	-	3
So	Pueblo			
	<b>6</b>			

6	Trevor Bradley	26	-	9
Fr	McClintock	<b>Fall</b>	<b>Score</b>	
		1:56		

7	Cano, Andy	21	-	10
So	Canyon Del Oro			
	<b>7</b>			

7	Cano, Andy	22	-	10
So	Canyon Del Oro	<b>Fall</b>	<b>Score</b>	
		4		3

15	Travis Azevedo	14	-	7
Fr	Thunderbird			
	<b>8</b>			

2	Brandon Horton	16	-	3
FR	Lake Havasu	<b>Fall</b>	<b>Score</b>	
		13		7

**113**

1	Yobel Muchang	20	-	1
Fr	Saguaro	<b>Fall</b>	<b>Score</b>	
		11		5

**281**

1	Yobel Muchang	21	-	1
Fr	Saguaro	<b>Fall</b>	<b>Score</b>	
		1:58		

4	Herman, Brannon	29	-	12
So	Ironwood Rdg.	<b>Fall</b>	<b>Score</b>	
		6		4

**393**

2	<b>Brandon Horton</b>			
---	-----------------------	--	--	--

FR	Lake Havasu	<b>Fall</b>	<b>Score</b>	
		2:59		

Overall Record 19 - 3

6	Trevor Bradley	27	-	9
Fr	McClintock	<b>Fall</b>	<b>Score</b>	
		1:05		

**282**

2	Brandon Horton	18	-	3
FR	Lake Havasu	<b>Fall</b>	<b>Score</b>	
		1:58		

2	Brandon Horton	17	-	3
FR	Lake Havasu	<b>Fall</b>	<b>Score</b>	
		0:34		

**2006 AIA 4A Division I State Wrestling**

**Weight Class**

**112lb**

1	Matt Long	31	-	1
Sr	Moon Valley			
<b>9</b>				
16	BYE			

1	Matt Long	31	-	1
Sr	Moon Valley	<b>Fall</b>	<b>Score</b>	
		Bye	-	

9	Ortiz, Victor	4	-	2
So	Cienega			
<b>10</b>				
8	Ryan Steele	8	-	10
Jr	Saguaro			

8	Ryan Steele	9	-	10
Jr	Saguaro	<b>Fall</b>	<b>Score</b>	
		10	-	4

5	Armando Arrendondo	10	-	9
	Agua Fria			
<b>11</b>				
12	Francisco Alatorre	23	-	11
Sr	McClintock			

12	Francisco Alatorre	24	-	11
Sr	McClintock	<b>Fall</b>	<b>Score</b>	
		3:12	-	

13	Pisciotta, Matt	15	-	13
Jr	Catalina Foot.			
<b>12</b>				
4	Estillore, Robert	37	-	8
Sr	Pueblo			

4	Estillore, Robert	38	-	8
Sr	Pueblo	<b>Fall</b>	<b>Score</b>	
		1:40	-	

3	Villa, Jesus	32	-	4
Sr	Nogales			
<b>13</b>				
14	Joey Jimenez	11	-	9
	Copper Canyon			

3	Villa, Jesus	33	-	4
Sr	Nogales	<b>Fall</b>	<b>Score</b>	
		0:50	-	

11	Peters, Matt	24	-	14
So	Ironwood Rdg.			
<b>14</b>				
6	Nick Hosler	26	-	9
Jr	Prescott			

11	Peters, Matt	25	-	14
So	Ironwood Rdg.	<b>Fall</b>	<b>Score</b>	
		15	-	0

7	Dominguez, Steven	22	-	9
So	Canyon Del Oro			
<b>15</b>				
10	Nate Peterson	15	-	18
	Willow Canyon			

7	Dominguez, Steven	23	-	9
So	Canyon Del Oro	<b>Fall</b>	<b>Score</b>	
		5:26	-	

15	Anthony Wagner	9	-	7
Fr	Independence			
<b>16</b>				
2	Nick Saenz	25	-	3
Sr	Thunderbird			

2	Nick Saenz	26	-	3
Sr	Thunderbird	<b>Fall</b>	<b>Score</b>	
		0:30	-	

1	Matt Long	32	-	1
Sr	Moon Valley	<b>Fall</b>	<b>Score</b>	
		5:04	-	

1	Matt Long	33	-	1
Sr	Moon Valley	<b>Fall</b>	<b>Score</b>	
		3:18	-	

4	Estillore, Robert	39	-	8
Sr	Pueblo	<b>Fall</b>	<b>Score</b>	
		4:37	-	

1	Matt Long			
Sr	Moon Valley	<b>Fall</b>	<b>Score</b>	
		7	-	2

	Overall Record	34	-	1

3	Villa, Jesus	34	-	4
Sr	Nogales	<b>Fall</b>	<b>Score</b>	
		3:59	-	

2	Nick Saenz	28	-	3
Sr	Thunderbird	<b>Fall</b>	<b>Score</b>	
		11	-	1

2	Nick Saenz	27	-	3
Sr	Thunderbird	<b>Fall</b>	<b>Score</b>	
		16	-	0

285

394

286

121

122

123

124



**2006 AIA 4A Division I State Wrestling**

**Weight Class**

**119lb**

1	David Leaphart	12	-	3
Jr	Thunderbird			
	17			
16	BYE			

1	David Leaphart	12	-	3
Jr	Thunderbird	Fall	Score	
		Bye	-	

9	Daniel Felix	13	-	12
So	Independence			
	18			
8	Kent, Kevin	21	-	20
Fr	Marana			

9	Daniel Felix	14	-	12
So	Independence	Fall	Score	

5	Miles, Adam	28	-	8
So	Cienega			
	19			
12	Gorney, Ryan	13	-	8
Jr	Ironwood Rgd.			

5	Miles, Adam	29	-	8
So	Cienega	Fall	Score	

13	Daniel McCarty	24	-	9
Sr	Prescott			
	20			
4	Freddy Torres	27	-	6
	Millennium			

4	Freddy Torres	28	-	6
	Millennium	Fall	Score	
		3:41	-	

3	Ashton Lichlyter	29	-	6
Jr	Moon Valley			
	21			
14	Benitez, Justin	11	-	17
Fr	Amphi			

3	Ashton Lichlyter	30	-	6
Jr	Moon Valley	Fall	Score	
		1:15	-	

11	Derrick Wade	23	-	12
	Willow Canyon			
	22			
6	Mike Mailloux	3	-	15
So	Saguaro			

11	Derrick Wade	24	-	12
	Willow Canyon	Fall	Score	
		2:26	-	

7	Anthony Denofre	23	-	15
	Agua Fria			
	23			
10	Linaker, Charlie	5	-	5
Jr	Catalina Foot.			

10	Linaker, Charlie	6	-	5
Jr	Catalina Foot.	Fall	Score	

15	Jacob Ross	8	-	12
So	Pinnacle			
	24			
2	Islas, David	45	-	2
Jr	Pueblo			

2	Islas, David	46	-	2
Jr	Pueblo	Fall	Score	
		1:30	-	

1	David Leaphart	13	-	3
Jr	Thunderbird	Fall	Score	
		1:15	-	

1	David Leaphart	14	-	3
Jr	Thunderbird	Fall	Score	
		15	-	0

4	Freddy Torres	29	-	6
	Millennium	Fall	Score	
		2:46	-	

2	Islas, David	48	-	2
Jr	Pueblo	Fall	Score	
		12	-	0

3	Ashton Lichlyter	31	-	6
Jr	Moon Valley	Fall	Score	
		7	-	5

2	Islas, David	47	-	2
Jr	Pueblo	Fall	Score	
		5:10	-	

2	Islas, David	11	-	2
Jr	Pueblo	Fall	Score	

Overall Record 49 - 2

**2006 AIA 4A Division I State Wrestling**

**Weight Class**

**125lb**

1	Steve Aragon	29	-	2
Sr	Moon Valley			
	25			

1	Steve Aragon	29	-	2
Sr	Moon Valley	Fall	Score	
	Bye			

9	Nichols, Brandon	9	-	13
Jr	Ironwood Rdg.			
	26			

9	Nichols, Brandon	10	-	13
Jr	Ironwood Rdg.	Fall	Score	

8	Donny Kashat	12	-	18
Sr	Pinnacle			

		16	-	0
--	--	----	---	---

5	Matt Barajas	23	-	9
	Agua Fria			
	27			

12	Vincent Bradley	29	-	8
So	McClintock	Fall	Score	
		7	-	4

12	Vincent Bradley	29	-	8
So	McClintock			

13	Ramirez, Robert	24	-	16
Sr	Pueblo			
	28			

4	Martinez, Tyler	23	-	6
Sr	Amphi	Fall	Score	

4	Martinez, Tyler	22	-	6
Sr	Amphi			

		4	-	1
--	--	---	---	---

3	Gallardo, Jesus	32	-	6
Sr	Rincon			
	29			

3	Gallardo, Jesus	33	-	6
Sr	Rincon	Fall	Score	

14	Anthony Monroy	22	-	19
	Millennium			

		5	-	0
--	--	---	---	---

11	Ford, Sterling	6	-	2
Jr	Cienega			
	30			

6	Jeremy Mazon	34	-	6
Jr	Prescott	Fall	Score	

6	Jeremy Mazon	33	-	6
Jr	Prescott			

		Forfeit		

7	Stratton, Doug	26	-	6
Jr	Sahuaro			
	31			

10	Eric Johnson	16	-	10
	Lake Havasu	Fall	Score	
		Forfeit		

10	Eric Johnson	15	-	10
	Lake Havasu			

--	--	--	--	--

15	Garrison Feldman	15	-	7
Jr	Independence			
	32			

2	Zach Mainez	25	-	3
Jr	Thunderbird	Fall	Score	

2	Zach Mainez	24	-	3
Jr	Thunderbird			

		12	-	2
--	--	----	---	---

1	Steve Aragon	30	-	2
Sr	Moon Valley	Fall	Score	
		16	-	1

1	Steve Aragon	31	-	2
Sr	Moon Valley	Fall	Score	
		11	-	6

4	Martinez, Tyler	24	-	6
Sr	Amphi	Fall	Score	
		4:53		

1	Steve Aragon			
Sr	Moon Valley	Fall	Score	
		5	-	4

6	Jeremy Mazon	35	-	6
Jr	Prescott	Fall	Score	
		9	-	1

6	Jeremy Mazon	36	-	6
Jr	Prescott	Fall	Score	
		10	-	9

2	Zach Mainez	26	-	3
Jr	Thunderbird	Fall	Score	
		1:19		

1	Steve Aragon	31	-	2
Sr	Moon Valley	Fall	Score	
		11	-	6

1	Steve Aragon			
Sr	Moon Valley	Fall	Score	
		5	-	4

		Overall Record	32	-	2
--	--	----------------	----	---	---

6	Jeremy Mazon	36	-	6
Jr	Prescott	Fall	Score	
		10	-	9

**2006 AIA 4A Division I State Wrestling**

**Weight Class**

**130lb**

1	Ricky Abril	23	-	4
Jr	Thunderbird			
	<b>33</b>			
16	BYE			

1	Ricky Abril	23	-	4
Jr	Thunderbird	<b>Fall</b>	<b>Score</b>	
	Bye			

9	Parra, Malik	10	-	5
Fr	Nogales			
	<b>34</b>			
8	Jaron Marigliano	15	-	6
	Copper Canyon			

8	Jaron Marigliano	16	-	6
	Copper Canyon	<b>Fall</b>	<b>Score</b>	
		10	-	8

5	Trent Tewers	23	-	8
Sr	Moon Valley			
	<b>35</b>			
12	Ronnie King	17	-	12
	Lake Havasu			

12	Ronnie King	18	-	12
	Lake Havasu	<b>Fall</b>	<b>Score</b>	
		5	-	3

13	Acorn, Nick	25	-	10
Sr	Sahuaro			
	<b>36</b>			
4	Robles, Robert	9	-	3
Jr	Pueblo			

4	Robles, Robert	10	-	3
Jr	Pueblo	<b>Fall</b>	<b>Score</b>	
		9	-	3

3	Jablonski, Mike	15	-	4
Jr	Cienega			
	<b>37</b>			
14	Josh Hogan	12	-	4
So	Independence			

3	Jablonski, Mike	16	-	4
Jr	Cienega	<b>Fall</b>	<b>Score</b>	
		6	-	2

11	Otero, Niko	12	-	7
Sr	Canyon Del Oro			
	<b>38</b>			
6	Mike Moore	27	-	5
Sr	McClintock			

6	Mike Moore	28	-	5
Sr	McClintock	<b>Score</b>		
		18	-	7

7	Bourquet, Treyvor	35	-	9
Fr	Marana			
	<b>39</b>			
10	Max Payne	11	-	4
Fr	Prescott			

7	Bourquet, Treyvor	36	-	9
Fr	Marana	<b>Fall</b>	<b>Score</b>	
		5:42		-

15	Kyle Carfagna	10	-	15
Jr	Pinnacle			
	<b>40</b>			
2	Marquis Mitchell	37	-	7
	Agua Fria			

2	Marquis Mitchell	38	-	7
	Agua Fria	<b>Fall</b>	<b>Score</b>	
		1:17		-

1	Ricky Abril	24	-	4
Jr	Thunderbird	<b>Fall</b>	<b>Score</b>	
		9	-	3

1	Ricky Abril	25	-	4
Jr	Thunderbird	<b>Fall</b>	<b>Score</b>	
		14	-	6

12	Ronnie King	19	-	12
	Lake Havasu	<b>Fall</b>	<b>Score</b>	
		7	-	1

3	Jablonski, Mike	17	-	4
Jr	Cienega	<b>Fall</b>	<b>Score</b>	
		4	-	2

3	Jablonski, Mike	18	-	4
Jr	Cienega	<b>Fall</b>	<b>Score</b>	
		8	-	3

2	Marquis Mitchell	39	-	7
	Agua Fria	<b>Fall</b>	<b>Score</b>	
		5:33		-

1	Ricky Abril	25	-	4
Jr	Thunderbird	<b>Fall</b>	<b>Score</b>	
		14	-	6

3	Jablonski, Mike	18	-	4
Jr	Cienega	<b>Fall</b>	<b>Score</b>	
		8	-	3

3	Jablonski, Mike	18	-	4
Jr	Cienega	<b>Fall</b>	<b>Score</b>	
		8	-	3

397

3	Jablonski, Mike	19	-	4
Jr	Cienega	<b>Fall</b>	<b>Score</b>	
		8	-	7
	Overall Record	19	-	4

**2006 AIA 4A Division I State Wrestling**

**Weight Class**

**135lb**

1 Daniel Iribe 19 - 2

Copper Canyon  
41

1 Daniel Iribe 19 - 2

Copper Canyon Fall Score  
Bye -

16 BYE

153

1 Daniel Iribe 20 - 2

Copper Canyon Fall Score  
16 - 7

9 Brett Whalen 18 - 17

Sr Cactus  
42

9 Brett Whalen 19 - 17

Sr Cactus Fall Score  
9 - 5

8 Blake Arland 11 - 14

So Pinnacle

301

1 Daniel Iribe 21 - 2

Copper Canyon Fall Score  
14 - 7

5 Veramontes, Emilio 13 - 22

So Amphi  
43

12 Daniel Muchang 25 - 4

Jr Saguaro Fall Score  
1:40 -

12 Daniel Muchang 24 - 4

Jr Saguaro

154

13 Cameron Vannoy 20 - 12

Sr Moon Valley Fall Score  
Default -

13 Cameron Vannoy 18 - 12

Sr Moon Valley  
44

13 Cameron Vannoy 19 - 12

Sr Moon Valley Fall Score  
1:53 -

4 Cutright, Mark 23 - 16

So Pueblo

398

2 Rishpal Saini

Sr Thunderbird Fall Score  
7 - 2

3 Ryan Donaldson 27 - 9

Jr Prescott  
45

3 Ryan Donaldson 28 - 9

Jr Prescott Fall Score  
4:32 -

14 Brubaker, Bobby 19 - 12

Jr Nogales

155

3 Ryan Donaldson 29 - 9

Jr Prescott Fall Score  
5:42 -

11 Ballinger, Kyle 15 - 13

Fr Canyon Del Oro  
46

6 David Baldonado 31 - 8

Agua Fria Fall Score  
1:30 -

6 David Baldonado 30 - 8

Agua Fria

302

2 Rishpal Saini 16 - 2

Sr Thunderbird Fall Score  
5:55 -

7 Higuera, Alex 22 - 18

Sr Marana  
47

7 Higuera, Alex 23 - 18

Sr Marana Fall Score  
7 - 2

10 Riddle, Jason 4 - 7

Sr Cienega

156

2 Rishpal Saini 15 - 2

Sr Thunderbird Fall Score  
18 - 3

15 Steve Taylor 19 - 16

Millennium  
48

2 Rishpal Saini 14 - 2

Sr Thunderbird Fall Score  
3:04 -

2 Rishpal Saini 13 - 2

Sr Thunderbird

**2006 AIA 4A Division I State Wrestling**

**Weight Class**

**140lb**

1 Baker, Mitch 43 - 2

Sr Marana  
49

16 BYE

9 Mark Malleo 9 - 11

Sr Cactus  
50

8 Dickerson, Layton 15 - 18

So Amphi

5 Ryan Parman 13 - 3

Sr Thunderbird  
51

12 May, Ryan 22 - 17

So Cienega

13 Josh Wolfe 26 - 10

Jr Prescott  
52

4 Doug Alexander 19 - 4

Agua Fria

3 James Eastin 29 - 5

Jr Moon Valley  
53

14 Adam Carey 11 - 15

So Saguaro

11 Justin Draper 14 - 7

Willow Canyon  
54

6 Extract, Steve 17 - 11

So Ironwood Rdg.

7 Kyle Clark 22 - 8

Lake Havasu  
55

10 Tyler Roberts 2 - 6

So McClintock

15 Honan, Paul 7 - 8

Fr Canyon Del Oro  
56

2 Khuu, Dan 14 - 2

Sr Catalina

1 Baker, Mitch 43 - 2

Sr Marana  
Fall Score  
Bye -

161

9 Mark Malleo 10 - 11

Sr Cactus  
Fall Score  
7 - 2

5 Ryan Parman 14 - 3

Sr Thunderbird  
Fall Score  
14 - 3

162

4 Doug Alexander 20 - 4

Agua Fria  
Fall Score  
12 - 4

3 James Eastin 30 - 5

Jr Moon Valley  
Fall Score  
1:19 -

163

6 Extract, Steve 18 - 11

So Ironwood Rdg.  
Fall Score  
4:06 -

7 Kyle Clark 23 - 8

Lake Havasu  
Fall Score  
6 - 2

164

2 Khuu, Dan 15 - 2

Sr Catalina  
Fall Score  
5 - 4

1 Baker, Mitch 44 - 2

Sr Marana  
Fall Score  
1:15 -

305

4 Doug Alexander 21 - 4

Agua Fria  
Fall Score  
12 - 5

1 Baker, Mitch 45 - 2

Sr Marana  
Fall Score  
14 - 5

399

1 Baker, Mitch

Sr Marana  
Fall Score  
3:32 -

Overall Record 46 - 2

6 Extract, Steve 19 - 11

So Ironwood Rdg.  
Fall Score  
6 - 5

306

6 Extract, Steve 20 - 11

So Ironwood Rdg.  
Fall Score  
6 - 4

2 Khuu, Dan 16 - 2

Sr Catalina  
Fall Score  
9 - 7

**2006 AIA 4A Division I State Wrestling**

**Weight Class**

**145lb**

1 Jake Peterson 18 - 2

So Pinnacle  
57

16 BYE

1 Jake Peterson 18 - 2  
So Pinnacle **Fall** **Score**  
Bye -

169

9 Michael Gartner 13 - 15

So Greenway  
58

8 Wilton, Garrett 18 - 6

Jr Canyon Del Oro

8 Wilton, Garrett 19 - 6  
Jr Canyon Del Oro **Fall** **Score**  
6 - 2

309

5 Lor, Orson 26 - 12

So Amphi  
59

12 Castillo, Carlos 23 - 5

Sr Pueblo

5 Lor, Orson 27 - 12  
So Amphi **Fall** **Score**  
15 - 5

170

13 Carlton Carson 17 - 12

Sr Moon Valley  
60

4 Job Mills 31 - 7

Agua Fria

13 Carlton Carson 18 - 12  
Sr Moon Valley **Fall** **Score**  
Default -

1 Jake Peterson 19 - 2

So Pinnacle **Fall** **Score**  
12 - 0

1 Jake Peterson 20 - 2

So Pinnacle **Fall** **Score**  
12 - 0

400

3 Jimmy Lee 11 - 3

Jr Apollo  
61

14 Ochoa, Adam 17 - 15

Jr Nogales

3 Jimmy Lee 12 - 3  
Jr Apollo **Fall** **Score**  
0:48 -

171

11 Tristan Tyson 14 - 6

Copper Canyon  
62

6 Adam Torres 12 - 11

So Thunderbird

6 Adam Torres 13 - 11  
So Thunderbird **Fall** **Score**  
Forfeit -

310

7 Cody Taylor 12 - 3

Willow Canyon  
63

10 Morris, Billy 18 - 4

Jr Catalina Foot.

10 Morris, Billy 19 - 4  
Jr Catalina Foot. **Fall** **Score**  
3:04 -

172

15 Michel Espinoza 9 - 17

So McClintock  
64

2 Esparaza, Chris 40 - 5

Sr Marana

2 Esparaza, Chris 41 - 5  
Sr Marana **Fall** **Score**  
1:51 -

6 Adam Torres 14 - 11  
So Thunderbird **Fall** **Score**  
7 - 2

10 Morris, Billy 20 - 4  
Jr Catalina Foot. **Fall** **Score**  
1:45 -

1 Jake Peterson  
So Pinnacle **Fall** **Score**

2 - 1

Overall Record 21 - 2

6 Adam Torres 15 - 11

So Thunderbird **Fall** **Score**  
7 - 5

**2006 AIA 4A Division I State Wrestling**

**Weight Class**

**152lb**

1 Barron, Matt 37 - 4

Sr Canyon Del Oro  
65

16 BYE

9 Kendon Hatch 15 - 15

So Cactus  
66

8 Homer, Brandon 11 - 9

Jr Cienega

5 Judah Montenegro 2 - 0

Millennium  
67

12 Khan, Dilwar 9 - 4

Sr Catalina

13 Joey Martin 12 - 15

Sr Prescott  
68

4 Colin Keleher 16 - 5

Jr Chaparral

3 Anthony Moya 13 - 4

Fr Moon Valley  
69

14 Ian Blazek 4 - 10

Agua Fria

11 Bobby Baker 6 - 11

Sr Thunderbird  
70

6 Esparza, Larry 39 - 7

Sr Marana

7 Mike Schutz 3 - 2

Jr Saguaro  
71

10 Andy Chavez 10 - 2

Copper Canyon

15 Garcia, Mathew 34 - 13

Sr Pueblo  
72

2 Sanchez, Tony 26 - 7

Sr Nogales

1 Barron, Matt 37 - 4

Sr Canyon Del Oro  
Fall Score  
Bye -

177

8 Homer, Brandon 12 - 9

Jr Cienega  
Fall Score  
8 - 2

12 Khan, Dilwar 10 - 4

Sr Catalina  
Fall Score  
16 - 9

178

13 Joey Martin 13 - 15

Sr Prescott  
Fall Score  
19 - 5

3 Anthony Moya 14 - 4

Fr Moon Valley  
Fall Score  
15 - 5

179

6 Esparza, Larry 40 - 7

Sr Marana  
Fall Score  
5:51 -

10 Andy Chavez 11 - 2

Copper Canyon  
Fall Score  
7 - 6

180

15 Garcia, Mathew 35 - 13

Sr Pueblo  
Fall Score  
9 - 2

1 Barron, Matt 38 - 4

Sr Canyon Del Oro  
Fall Score  
1:57 -

313

13 Joey Martin 14 - 15

Sr Prescott  
Fall Score  
5:44 -

401

6 Esparza, Larry 41 - 7

Sr Marana  
Fall Score  
8 - 6

314

6 Esparza, Larry 42 - 7

Sr Marana  
Fall Score  
8 - 4

15 Garcia, Mathew 36 - 13

Sr Pueblo  
Fall Score  
0:40 -

1 Barron, Matt 39 - 4

Sr Canyon Del Oro  
Fall Score  
1:47 -

1 Barron, Matt

Sr Canyon Del Oro  
Fall Score  
10 - 4

Overall Record 40 - 4

**2006 AIA 4A Division I State Wrestling**

**Weight Class**

**160lb**

1 Brennen Spratte 23 - 2

Lake Havasu  
73

1 Brennen Spratte 23 - 2

Lake Havasu Fall Score  
Bye -

16 BYE

185

1 Brennen Spratte 24 - 2

Lake Havasu Fall Score  
4:53 -

9 Luis Guerra 14 - 12

So Independence  
74

8 Goodman, Jacob 24 - 9

Sr Sabino Fall Score  
2:30 -

8 Goodman, Jacob 23 - 9

Sr Sabino

317

12 Reedy, Ben 34 - 5

Sr Ironwood Rdg. Fall Score  
4 - 2

5 Adam Cherrington 17 - 10

So Pinnacle  
75

12 Reedy, Ben 32 - 5

Sr Ironwood Rdg. Fall Score  
15 - 2

12 Reedy, Ben 31 - 5

Sr Ironwood Rdg.

186

12 Reedy, Ben 33 - 5

Sr Ironwood Rdg. Fall Score  
11 - 0

13 Jacob Jarvis 17 - 8

Fr Prescott  
76

4 Martinez, Fernando 23 - 10

Jr Nogales Fall Score  
16 - 8

4 Martinez, Fernando 22 - 10

Jr Nogales

402

2 Anaya, Dominick

Sr Pueblo Fall Score  
9 - 5

3 Eric Manoogian 12 - 4

Sr Moon Valley  
77

3 Eric Manoogian 13 - 4

Sr Moon Valley Fall Score  
1:30 -

14 Keaton Benson 8 - 12

Sr Thunderbird

187

3 Eric Manoogian 14 - 4

Sr Moon Valley Fall Score  
1:21 -

11 Gudeman, Brock 13 - 9

So Cienega  
78

6 Pat Marshall 22 - 14

Willow Canyon Fall Score  
3 - 2

6 Pat Marshall 21 - 14

Willow Canyon

318

2 Anaya, Dominick 42 - 10

Sr Pueblo Fall Score  
5:59 -

7 Morales, Zoar 19 - 12

So Catalina  
79

10 Lowen Sniff 15 - 8

Sr Saguaro Fall Score  
3:47 -

10 Lowen Sniff 14 - 8

Sr Saguaro

188

2 Anaya, Dominick 41 - 10

Sr Pueblo Fall Score  
2:25 -

15 Tony Ventura 17 - 11

Agua Fria  
80

2 Anaya, Dominick 40 - 10

Sr Pueblo Fall Score  
1:47 -

2 Anaya, Dominick 39 - 10

Sr Pueblo

Overall Record 43 - 10



**2006 AIA 4A Division I State Wrestling**

**Weight Class 171lb**

1	Diego Bencomo	31	-	1
So	Independence			
<b>81</b>				
16	BYE			

1	Diego Bencomo	31	-	1
So	Independence	<b>Fall</b>	<b>Score</b>	
		Bye	-	
<b>193</b>				

9	Eric Force	22	-	7
Sr	Thunderbird			
<b>82</b>				
8	Belding, Ryab	13	-	5
Sr	Marana			

9	Eric Force	23	-	7
Sr	Thunderbird	<b>Fall</b>	<b>Score</b>	

5	Alentado, Vince	14	-	11
Jr	Catalina Foot.			
<b>83</b>				
12	Lopez, Robert	32	-	8
Jr	Pueblo			

12	Lopez, Robert	33	-	8
Jr	Pueblo	<b>Fall</b>	<b>Score</b>	
		8	-	2
<b>194</b>				

13	Robert Slaughter	23	-	10
Sr	McClintock			
<b>84</b>				
4	Nick Caporrino	18	-	6
	Millennium			

13	Robert Slaughter	24	-	10
Sr	McClintock	<b>Fall</b>	<b>Score</b>	
		0:55	-	

3	Sean Land	26	-	8
So	Pinnacle			
<b>85</b>				
14	Marrufo, Josh	23	-	12
Jr	Sahuaro			

3	Sean Land	27	-	8
So	Pinnacle	<b>Fall</b>	<b>Score</b>	
		5:07	-	
<b>195</b>				

11	Johnny Cordova	8	-	10
	Copper Canyon			
<b>86</b>				
6	Adam Webster	12	-	3
Sr	Greenway			

6	Adam Webster	13	-	3
Sr	Greenway	<b>Fall</b>	<b>Score</b>	
		17	-	2

7	Eric Burger	31	-	9
	Agua Fria			
<b>87</b>				
10	Sullivan, Justin	25	-	11
Jr	Cienega			

10	Sullivan, Justin	26	-	11
Jr	Cienega	<b>Fall</b>	<b>Score</b>	
		11	-	3
<b>196</b>				

15	Ben Monarrez	11	-	15
Fr	Cactus			
<b>88</b>				
2	Comi, Troy	29	-	6
Sr	Ironwood Rdg.			

2	Comi, Troy	30	-	6
Sr	Ironwood Rdg.	<b>Fall</b>	<b>Score</b>	
		Default	-	

1	Diego Bencomo	32	-	1
So	Independence	<b>Fall</b>	<b>Score</b>	
		8	-	4

12	Lopez, Robert	34	-	8
Jr	Pueblo	<b>Fall</b>	<b>Score</b>	
		9	-	4

6	Adam Webster	14	-	3
Sr	Greenway	<b>Fall</b>	<b>Score</b>	
		5:21	-	

2	Comi, Troy	31	-	6
Sr	Ironwood Rdg.	<b>Fall</b>	<b>Score</b>	
		5	-	4

1	Diego Bencomo	33	-	1
So	Independence	<b>Fall</b>	<b>Score</b>	
		16	-	7

1	Diego Bencomo	34	-	1
So	Independence	<b>Fall</b>	<b>Score</b>	
		18	-	9
Overall Record				
		34	-	1

2	Comi, Troy	32	-	6
Sr	Ironwood Rdg.	<b>Fall</b>	<b>Score</b>	
		11	-	5

**2006 AIA 4A Division I State Wrestling**

**Weight Class**

**189lb**

1	Mack Surrell	17	-	2
Jr	Thunderbird			
	<b>89</b>			
16	BYE			

1	Mack Surrell	17	-	2
Jr	Thunderbird	<b>Fall</b>	<b>Score</b>	
	Bye			

**201**

9	Borbon, Jeremy	19	-	9
Sr	Catalina			
	<b>90</b>			
8	Roy Horstman	3	-	7
	Lake Havasu			

9	Borbon, Jeremy	20	-	9
Sr	Catalina	<b>Fall</b>	<b>Score</b>	
		2:25		

1	Mack Surrell	18	-	2
Jr	Thunderbird	<b>Fall</b>	<b>Score</b>	
		0:58		

**325**

5	Justin Busto	17	-	10
Jr	Greenway			
	<b>91</b>			
12	Johnny Coraso	10	-	12
	Millennium			

5	Justin Busto	18	-	10
Jr	Greenway	<b>Fall</b>	<b>Score</b>	
		10		1

**202**

13	Maestas, Mike	30	-	9
Jr	Amphi			
	<b>92</b>			
4	Yribe, Mario	29	-	10
Jr	Pueblo			

13	Maestas, Mike	31	-	9
Jr	Amphi	<b>Fall</b>	<b>Score</b>	
		16		1

13	Maestas, Mike	32	-	9
Jr	Amphi	<b>Fall</b>	<b>Score</b>	
		5:43		

**404**

3	Hoover, Ben	25	-	7
Sr	Sahuaro			
	<b>93</b>			
14	Bryant Green	18	-	8
Jr	Apollo			

3	Hoover, Ben	26	-	7
Sr	Sahuaro	<b>Fall</b>	<b>Score</b>	
		4:47		

**203**

11	Short, Michael	22	-	16
So	Ironwood Rdg.			
	<b>94</b>			
6	Eric Johnson	9	-	7
Sr	Pinnacle			

6	Eric Johnson	10	-	7
Sr	Pinnacle	<b>Fall</b>	<b>Score</b>	
		12		2

3	Hoover, Ben	27	-	7
Sr	Sahuaro	<b>Fall</b>	<b>Score</b>	
		8		0

**326**

7	Moreno, Michael	28	-	13
So	Marana			
	<b>95</b>			
10	Josh Martinez	24	-	11
Sr	Prescott			

7	Moreno, Michael	29	-	13
So	Marana	<b>Fall</b>	<b>Score</b>	
		6:24		

**204**

15	Koree Simpson	3	-	8
Jr	McClintock			
	<b>96</b>			
2	George Espinoza	32	-	7
	Agua Fria			

2	George Espinoza	33	-	7
	Agua Fria	<b>Fall</b>	<b>Score</b>	
		3:43		

7	Moreno, Michael	30	-	13
So	Marana	<b>Fall</b>	<b>Score</b>	
		3		1

1	Mack Surrell	19	-	2
Jr	Thunderbird	<b>Fall</b>	<b>Score</b>	
		1:22		

1	Mack Surrell			
Jr	Thunderbird	<b>Fall</b>	<b>Score</b>	
		7		1
	Overall Record	20		2

**2006 AIA 4A Division I State Wrestling**

**Weight Class**

**215lb**

1	Jose Sanchez	26	-	2
Jr	Independence			
	<b>97</b>			
16	BYE			

1	Jose Sanchez	26	-	2
Jr	Independence	<b>Fall</b>	<b>Score</b>	
		Bye	-	

**209**

9	Tim Glover	12	-	15
Sr	McClintock			
	<b>98</b>			
8	Allen, Carlos	12	-	5
Sr	Catalina			

8	Allen, Carlos	13	-	5
Sr	Catalina	<b>Fall</b>	<b>Score</b>	
		3:16	-	

**329**

5	John Strawther	11	-	5
	Millennium			
	<b>99</b>			
12	Grijalva, Frank	16	-	6
Sr	Nogales			

12	Grijalva, Frank	17	-	6
Sr	Nogales	<b>Fall</b>	<b>Score</b>	
		4:15	-	

**210**

13	Omar Khalil	20	-	8
Sr	Saguaro			
	<b>100</b>			
4	Reichert, Eric	14	-	5
So	Ironwood Rdg.			

4	Reichert, Eric	15	-	5
So	Ironwood Rdg.	<b>Fall</b>	<b>Score</b>	
		3:04	-	

**405**

3	Ian Smith	8	-	2
Jr	Thunderbird			
	<b>101</b>			
14	Mike Ligouri-Reid	13	-	19
	Willow Canyon			

3	Ian Smith	9	-	2
Jr	Thunderbird	<b>Fall</b>	<b>Score</b>	
		0:33	-	

**211**

11	Nichols, James	11	-	8
So	Canyon Del Oro			
	<b>102</b>			
6	Jose Munoz	24	-	8
Sr	Moon Valley			

6	Jose Munoz	25	-	8
Sr	Moon Valley	<b>Fall</b>	<b>Score</b>	
		13	-	1

**330**

7	Santamaria, Jesus	25	-	14
Sr	Pueblo			
	<b>103</b>			
10	Edgar Patino	13	-	12
	Lake Havasu			

7	Santamaria, Jesus	26	-	14
Sr	Pueblo	<b>Fall</b>	<b>Score</b>	
		14	-	1

**212**

15	Nick Thurman	16	-	10
Jr	Apollo			
	<b>104</b>			
2	Brunson, Lonnie	32	-	5
Sr	Sahuaro			

2	Brunson, Lonnie	33	-	5
Sr	Sahuaro	<b>Fall</b>	<b>Score</b>	
		1:10	-	

1	Jose Sanchez	27	-	2
Jr	Independence	<b>Fall</b>	<b>Score</b>	
		9	-	3

4	Reichert, Eric	16	-	5
So	Ironwood Rdg.	<b>Fall</b>	<b>Score</b>	
		7	-	2

1	Jose Sanchez	28	-	2
Jr	Independence	<b>Fall</b>	<b>Score</b>	
		6	-	4

2	<b>Brunson, Lonnie</b>			
Sr	Sahuaro	<b>Fall</b>	<b>Score</b>	
		7	-	3
	Overall Record	36	-	5

2	Brunson, Lonnie	35	-	5
Sr	Sahuaro	<b>Fall</b>	<b>Score</b>	
		8	-	6

2	Brunson, Lonnie	34	-	5
Sr	Sahuaro	<b>Fall</b>	<b>Score</b>	
		14	-	6

**2006 AIA 4A Division I State Wrestling**

**Weight Class**

**HWT**

1 Miranda-Fitzgerald, Sean 29 - 0

Sr Catalina  
105

16 BYE

9 Brown, Cliff 12 - 14

So Canyon Del Oro  
106

8 J. D. Hanley 19 - 17

Sr Greenway

5 Mike Hernandez 18 - 14

Jr McClintock  
107

12 Cory Cavazos 18 - 11

Jr Apollo

13 Coroando, Edgar 23 - 13

Sr Pueblo  
108

4 Chris Green 25 - 4

Millennium

3 Petty, Mar-Kell 30 - 4

Sr Sabino  
109

14 Thomas Arigi 6 - 10

Sr Pinnacle

11 Guillermo Loyola 16 - 12

Willow Canyon  
110

6 Sobarzo, Marshal 27 - 8

Jr Nogales

7 Jake Stucky 29 - 7

Agua Fria  
111

10 Pat Sparks 1 - 2

Sr Thunderbird

15 Romero, Robert 30 - 10

Sr Amphi  
112

2 Diamond Johnson 26 - 2

Sr Independence

1 Miranda-Fitzgerald, Sean 29 - 0

Sr Catalina **Fall** **Score**  
Bye -

217

8 J. D. Hanley 20 - 17

Sr Greenway **Fall** **Score**  
2:38 -

12 Cory Cavazos 19 - 11

Jr Apollo **Fall** **Score**  
1:46 -

218

4 Chris Green 26 - 4

Millennium **Fall** **Score**  
2:52 -

3 Petty, Mar-Kell 31 - 4

Sr Sabino **Fall** **Score**  
1:10 -

219

6 Sobarzo, Marshal 28 - 8

Jr Nogales **Fall** **Score**  
1:03 -

7 Jake Stucky 30 - 7

Agua Fria **Fall** **Score**  
3:40 -

220

2 Diamond Johnson 27 - 2

Sr Independence **Fall** **Score**  
2:42 -

8 J. D. Hanley 21 - 17

Sr Greenway **Fall** **Score**  
4 - 3

333

4 Chris Green 27 - 4

Millennium **Fall** **Score**  
4:22 -

406

6 Sobarzo, Marshal 29 - 8

Jr Nogales **Fall** **Score**  
2:32 -

334

2 Diamond Johnson 29 - 2

Sr Independence **Fall** **Score**  
0:52 -

2 Diamond Johnson 28 - 2

Sr Independence **Fall** **Score**  
2:28 -

8 J. D. Hanley 22 - 17

Sr Greenway **Fall** **Score**  
2 - 1

8 J. D. Hanley

Sr Greenway **Fall** **Score**  
5:19 -

Overall Record 23 - 17

2006 AIA 4A Division I State Wrestling

Weight Class 103lb

Consolation

16	BYE				
117					

9	Damir Dautobic	2	-	14
Fr	Cactus	Fall	Score	
			BYE	-

9	Damir Dautobic	1	-	14
Fr	Cactus			

225				
-----	--	--	--	--

7	Cano, Andy	23	-	11
So	Canyon Del Oro	Fall	Score	
		2:29		-

Loser of Bout 116

7	Cano, Andy	22	-	11
So	Canyon Del Oro			

12	Cole Marr	17	-	16
0	Willow Canyon			

12	Cole Marr	18	-	16
0	Willow Canyon	Fall	Score	
		8		5

13	Chris Kelly	8	-	12
So	Moon Valley			

226				
-----	--	--	--	--

3	Robert Cortez	27	-	12
So	Apollo	Fall	Score	
		2:25		-

Loser of Bout 115

3	Robert Cortez	26	-	12
So	Apollo			

14	Acorn, Adam	1	-	2
So	Sahuaro			

11	Lopez, Brandon	5	-	4
So	Pueblo	Fall	Score	
		17		3

11	Lopez, Brandon	4	-	4
So	Pueblo			

227				
-----	--	--	--	--

5	Tschirhart, Jake	20	-	10
So	Cienega	Fall	Score	
		10		5

Loser of Bout 114

5	Tschirhart, Jake	19	-	10
So	Cienega			

10	Hughes, Andrea	26	-	8
So	Catalina Foot.			

10	Hughes, Andrea	27	-	8
So	Catalina Foot.	Fall	Score	
		9		3

15	Travis Azevedo	14	-	8
Fr	Thunderbird			

228				
-----	--	--	--	--

10	Hughes, Andrea	28	-	8
So	Catalina Foot.	Fall	Score	
		12		0

Loser of Bout 113

8	Kevin Davis	12	-	24
0	Millennium			

283

281

282

284

7	Cano, Andy	24	-	11
So	Canyon Del Oro	Fall	Score	
		11		5

7	Cano, Andy	24	-	11
So	Canyon Del Oro	Fall	Score	
		11		5

4	Herman, Brannon	30	-	13
So	Ironwood Rdg.	Fall	Score	
		2:49		-

4	Herman, Brannon	29	-	13
So	Ironwood Rdg.			

6	Trevor Bradley	27	-	10
Fr	McClintock			

10	Hughes, Andrea	30	-	8
So	Catalina Foot.	Fall	Score	
		5		4

10	Hughes, Andrea	29	-	8
So	Catalina Foot.	Fall	Score	
		7		5

4	Herman, Brannon	31	-	13
So	Ironwood Rdg.	Fall	Score	
		8		4

4	Herman, Brannon	29	-	13
So	Ironwood Rdg.			

10	Hughes, Andrea	30	-	8
So	Catalina Foot.	Fall	Score	
		5		4

7	Cano, Andy	24	-	12
So	Canyon Del Oro			

6	Trevor Bradley	27	-	11
Fr	McClintock			

*Handwritten signature*

*Handwritten signature*

2006 AIA 4A Division I State Wrestling

Weight Class 112lb

Consolation

16	BYE				
	125				

9	Ortiz, Victor	5	-	3
So	Cienega	Fall	Score	
		BYE	-	

9	Ortiz, Victor	4	-	3
So	Cienega			

Loser of Bout 124

7	Dominguez, Steven	23	-	10
So	Canyon Del Oro			

7	Dominguez, Steven	24	-	10
So	Canyon Del Oro	Fall	Score	
		4:14	-	

5	Armando Arrendondo	10	-	10
	Agua Fria			

	126			
--	-----	--	--	--

13	Pisciotta, Matt	16	-	14
Jr	Catalina Foot.	Fall	Score	
		2:16	-	

13	Pisciotta, Matt	15	-	14
Jr	Catalina Foot.			

Loser of Bout 123

11	Peters, Matt	25	-	15
So	Ironwood Rdg.			

	287			
--	-----	--	--	--

11	Peters, Matt	26	-	15
So	Ironwood Rdg.	Fall	Score	
		4:42	-	

Loser of Bout 285

11	Peters, Matt	27	-	15
So	Ironwood Rdg.	Fall	Score	
		2	-	1

	339			
--	-----	--	--	--

Loser of Bout 286

4	Estillore, Robert	39	-	9
Sr	Pueblo			

3	Villa, Jesus	34	-	5
Sr	Nogales			

14	Joey Jimenez	11	-	10
	Copper Canyon			

	127			
--	-----	--	--	--

6	Nick Hosler	27	-	10
Jr	Prescott	Fall	Score	
		4:01	-	

6	Nick Hosler	26	-	10
Jr	Prescott			

Loser of Bout 122

12	Francisco Alatorre	24	-	12
Sr	McClintock			

12	Francisco Alatorre	25	-	12
Sr	McClintock	Fall	Score	
		4	-	1

12	Francisco Alatorre	27	-	12
Sr	McClintock	Fall	Score	
		4	-	3

12	Francisco Alatorre	26	-	12
Sr	McClintock	Fall	Score	
		5	-	1

10	Nate Peterson	15	-	19
	Willow Canyon			

	128			
--	-----	--	--	--

15	Anthony Wagner	10	-	8
Fr	Independence	Fall	Score	
		8	-	4

15	Anthony Wagner	9	-	8
Fr	Independence			

Loser of Bout 121

8	Ryan Steele	9	-	11
Jr	Saguaro			

8	Ryan Steele	10	-	11
Jr	Saguaro	Fall	Score	
		9	-	6

4	Estillore, Robert	40	-	9
Sr	Pueblo	Fall	Score	
		7	-	3

	367			
--	-----	--	--	--

12	Francisco Alatorre	27	-	12
Sr	McClintock	Fall	Score	
		4	-	3

*Francisco Alatorre*

4	Estillore, Robert	41	-	9
Sr	Pueblo	Fall	Score	
		4	-	2

11	Peters, Matt	27	-	16
So	Ironwood Rdg.			

	368			
--	-----	--	--	--

3	Villa, Jesus	34	-	6
Sr	Nogales			

*Francisco Alatorre*

3	Villa, Jesus	35	-	6
Sr	Nogales	Fall	Score	
		1	-	0

2006 AIA 4A Division I State Wrestling

Weight Class

119lb

Consolation

16	BYE
133	

8	Kent, Kevin	22	-	21
Fr	Marana	Fall	Score	
		BYE	-	

8	Kent, Kevin	21	-	21
Fr	Marana			

233	
-----	--

10	Linaker, Charlie	7	-	6
Jr	Catalina Foot.	Fall	Score	
		2:54	-	

Loser of Bout 132

10	Linaker, Charlie	6	-	6
Jr	Catalina Foot.			

12	Gorney, Ryan	13	-	9
Jr	Ironwood Rdg.			

12	Gorney, Ryan	14	-	9
Jr	Ironwood Rdg.	Fall	Score	
		13	-	5

13	Daniel McCarty	24	-	10
Sr	Prescott			

234	
-----	--

11	Derrick Wade	25	-	13
	Willow Canyon	Fall	Score	
		4:08	-	

Loser of Bout 131

11	Derrick Wade	24	-	13
	Willow Canyon			

14	Benitez, Justin	11	-	18
Fr	Amphi			

6	Mike Mailloux	4	-	16
So	Saguaro	Fall	Score	
		0:55	-	

6	Mike Mailloux	3	-	16
So	Saguaro			

235	
-----	--

5	Miles, Adam	30	-	9
So	Cienega	Fall	Score	
		8	-	3

Loser of Bout 130

5	Miles, Adam	29	-	9
So	Cienega			

7	Anthony Denofre	23	-	16
	Agua Fria			

7	Anthony Denofre	24	-	16
	Agua Fria	Fall	Score	
		2:43	-	

15	Jacob Ross	8	-	13
So	Pinnacle			

236	
-----	--

7	Anthony Denofre	25	-	16
	Agua Fria	Fall	Score	
		10	-	6

Loser of Bout 129

9	Daniel Felix	14	-	13
So	Independence			

291

10	Linaker, Charlie	8	-	6
Jr	Catalina Foot.	Fall	Score	
		4	-	2

341

4	Freddy Torres	30	-	7
	Millennium	Fall	Score	
		5	-	2

Loser of Bout 289

4	Freddy Torres	29	-	7
	Millennium			

Loser of Bout 290

3	Ashton Lichlyter	31	-	7
Jr	Moon Valley			

342

5	Miles, Adam	32	-	9
So	Cienega	Fall	Score	
		6	-	1

5	Miles, Adam	31	-	9
So	Cienega	Fall	Score	
		9	-	0

*Travis Williams*

5	Miles, Adam	33	-	9
So	Cienega	Fall	Score	
		9	-	6

10	Linaker, Charlie	8	-	7
Jr	Catalina Foot.			
		370		

*Travis Williams*

3	Ashton Lichlyter	31	-	8
Jr	Moon Valley			

3	Ashton Lichlyter	32	-	8
Jr	Moon Valley	Fall	Score	
		7	-	2

2006 AIA 4A Division I State Wrestling

Weight Class 125lb

Consolation

16	BYE				
	141				

8	Donny Kashat	13	-	19
Sr	Pinnacle	Fall	Score	
		BYE	-	

8	Donny Kashat	12	-	19
Sr	Pinnacle			

10	Eric Johnson	17	-	11
	Lake Havasu	Fall	Score	
		9	-	4

Loser of Bout 140

10	Eric Johnson	16	-	11
	Lake Havasu			

5	Matt Barajas	23	-	10
	Agua Fria			

5	Matt Barajas	24	-	10
	Agua Fria	Fall	Score	
		11	-	10

13	Ramirez, Robert	24	-	17
Sr	Pueblo			

3	Gallardo, Jesus	34	-	7
Sr	Rincon	Fall	Score	
		2:33	-	

Loser of Bout 139

3	Gallardo, Jesus	33	-	7
Sr	Rincon			

14	Anthony Monroy	22	-	20
	Millennium			

14	Anthony Monroy	23	-	20
	Millennium	Fall	Score	
		Forfeit	-	

11	Ford, Sterling	6	-	3
Jr	Cienega			

12	Vincent Bradley	31	-	9
So	McClintock	Fall	Score	
		4	-	0

Loser of Bout 138

12	Vincent Bradley	30	-	9
So	McClintock			

7	Stratton, Doug	26	-	7
Jr	Sahuaro			

15	Garrison Feldman	16	-	8
Jr	Independence	Fall	Score	
		Forfeit	-	

15	Garrison Feldman	15	-	8
Jr	Independence			

15	Garrison Feldman	17	-	8
Jr	Independence	Fall	Score	
		4:08	-	

Loser of Bout 137

9	Nichols, Brandon	10	-	14
Jr	Ironwood Rdg.			

295				
-----	--	--	--	--

295				
-----	--	--	--	--

293				
-----	--	--	--	--

294				
-----	--	--	--	--

344				
-----	--	--	--	--

344				
-----	--	--	--	--

344				
-----	--	--	--	--

3	Gallardo, Jesus	35	-	7
Sr	Rincon	Fall	Score	
		5	-	1

343				
-----	--	--	--	--

4	Martinez, Tyler	25	-	7
Sr	Amphi	Fall	Score	
		2	-	1

4	Martinez, Tyler	24	-	7
Sr	Amphi			

2	Zach Mainez	26	-	4
Jr	Thunderbird			

2	Zach Mainez	27	-	4
Jr	Thunderbird	Fall	Score	
		9	-	4

12	Vincent Bradley	32	-	9
So	McClintock	Fall	Score	
		11	-	4

3	Gallardo, Jesus	35	-	8
Sr	Rincon			

12	Vincent Bradley	32	-	10
So	McClintock			

4	Martinez, Tyler	25	-	7
Sr	Amphi	Fall	Score	
		2	-	1

2	Zach Mainez	28	-	4
Jr	Thunderbird	Fall	Score	
		Default	-	

2	Zach Mainez	27	-	4
Jr	Thunderbird	Fall	Score	
		9	-	4

3	Gallardo, Jesus	35	-	8
Sr	Rincon			

3	Gallardo, Jesus	36	-	8
Sr	Rincon	Fall	Score	
		9	-	3

*Thunderbird*

*Thunderbird*



2006 AIA 4A Division I State Wrestling

Weight Class 130lb

Consolation

16	BYE				
		149			

9	Parra, Malik	11	-	6	
Fr	Nogales	Fall	Score		
		BYE	-		

9	Parra, Malik	10	-	6	
Fr	Nogales				

241					
-----	--	--	--	--	--

7	Bourquet, Treyvor	37	-	10	
Fr	Marana	Fall	Score		
		4:15	-		

Loser of Bout 148

7	Bourquet, Treyvor	36	-	10	
Fr	Marana				

5	Trent Tewers	23	-	9	
Sr	Moon Valley				

5	Trent Tewers	24	-	9	
Sr	Moon Valley	Fall	Score		
		8	-	2	

13	Acorn, Nick	25	-	11	
Sr	Sahuaro				

242					
-----	--	--	--	--	--

5	Trent Tewers	25	-	9	
Sr	Moon Valley	Fall	Score		
		Default	-		

Loser of Bout 147

6	Mike Moore	28	-	6	
Sr	McClintock				

14	Josh Hogan	12	-	5	
So	Independence				

14	Josh Hogan	13	-	5	
So	Independence	Fall	Score		
		8	-	6	

11	Otero, Niko	12	-	8	
Sr	Canyon Del Oro				

243					
-----	--	--	--	--	--

14	Josh Hogan	14	-	5	
So	Independence	Fall	Score		
		16	-	11	

Loser of Bout 146

4	Robles, Robert	10	-	4	
Jr	Pueblo				

10	Max Payne	11	-	5	
Fr	Prescott				

10	Max Payne	12	-	5	
Fr	Prescott	Fall	Score		
		2:20	-		

15	Kyle Carfagna	10	-	16	
Jr	Pinnacle				

244					
-----	--	--	--	--	--

10	Max Payne	13	-	5	
Fr	Prescott	Fall	Score		
		9	-	7	

Loser of Bout 145

8	Jaron Marigliano	16	-	7	
	Copper Canyon				

299

345

300

346

Loser of Bout 297

12	Ronnie King	19	-	13	
	Lake Havasu				

Loser of Bout 298

2	Marquis Mitchell	39	-	8	
	Agua Fria				

5	Trent Tewers	26	-	9	
Sr	Moon Valley	Fall	Score		
		Default	-		

5	Trent Tewers	27	-	9	
Sr	Moon Valley	Fall	Score		
		8	-	5	

373					
-----	--	--	--	--	--

14	Josh Hogan	15	-	5	
So	Independence	Fall	Score		
		8	-	6	

14	Josh Hogan	16	-	5	
So	Independence	Fall	Score		
		Default	-		

5	Trent Tewers	27	-	9	
Sr	Moon Valley	Fall	Score		
		8	-	5	

*Travis Delance*

5	Trent Tewers	28	-	9	
Sr	Moon Valley	Fall	Score		
		2:57	-		

12	Ronnie King	19	-	14	
	Lake Havasu				
	374				

2	Marquis Mitchell	39	-	9	
	Agua Fria				

*Travis Delance*

*Travis Delance*

12	Ronnie King	20	-	14	
	Lake Havasu	Fall	Score		
		Default	-		

2006 AIA 4A Division I State Wrestling

Weight Class 135lb

Consolation

16	BYE				
	157				

8	Blake Arland	12	-	15
So	Pinnacle	Fall	Score	
		BYE	-	

8	Blake Arland	11	-	15
So	Pinnacle			

Loser of Bout 156

7	Higuera, Alex	23	-	19
Sr	Marana			

5	Veramontes, Emilio	13	-	23
So	Amphi			

	158			
--	-----	--	--	--

4	Cutright, Mark	24	-	17
So	Pueblo	Fall	Score	
		12	-	2

4	Cutright, Mark	23	-	17
So	Pueblo			

Loser of Bout 155

6	David Baldonado	31	-	9
	Agua Fria			

14	Brubaker, Bobby	19	-	13
Jr	Nogales			

	159			
--	-----	--	--	--

14	Brubaker, Bobby	20	-	13
Jr	Nogales	Fall	Score	
		6	-	3

11	Ballinger, Kyle	15	-	14
Fr	Canyon Del Oro			

Loser of Bout 154

12	Daniel Muchang	25	-	5
Jr	Saguaro			

10	Riddle, Jason	4	-	8
Sr	Cienega			

	160			
--	-----	--	--	--

15	Steve Taylor	20	-	17
	Millennium	Fall	Score	
		4:01	-	

15	Steve Taylor	19	-	17
	Millennium			

Loser of Bout 153

9	Brett Whalen	19	-	18
Sr	Cactus			

8	Blake Arland	13	-	15
So	Pinnacle	Fall	Score	
		2:31	-	

	303			
--	-----	--	--	--

6	David Baldonado	33	-	9
	Agua Fria	Fall	Score	
		5	-	4

	347			
--	-----	--	--	--

6	David Baldonado	32	-	9
	Agua Fria	Fall	Score	
		9	-	3

Loser of Bout 301

13	Cameron Vannoy	20	-	13
Sr	Moon Valley			

Loser of Bout 302

3	Ryan Donaldson	29	-	10
Jr	Prescott			

14	Brubaker, Bobby	21	-	13
Jr	Nogales	Fall	Score	
		Default	-	

	348			
--	-----	--	--	--

9	Brett Whalen	21	-	18
Sr	Cactus	Fall	Score	
		9	-	3

	304			
--	-----	--	--	--

9	Brett Whalen	20	-	18
Sr	Cactus	Fall	Score	
		3:49	-	

6	David Baldonado	33	-	9
	Agua Fria	Fall	Score	
		5	-	4

	347			
--	-----	--	--	--

13	Cameron Vannoy	21	-	13
Sr	Moon Valley	Fall	Score	
		8	-	6

	375			
--	-----	--	--	--

3	Ryan Donaldson	31	-	10
Jr	Prescott	Fall	Score	
		7	-	3

3	Ryan Donaldson	29	-	10
Jr	Prescott			

3	Ryan Donaldson	30	-	10
Jr	Prescott	Fall	Score	
		14	-	4

	348			
--	-----	--	--	--

9	Brett Whalen	21	-	18
Sr	Cactus	Fall	Score	
		9	-	3

	304			
--	-----	--	--	--

6	David Baldonado	33	-	10
	Agua Fria			
	376			

9	Brett Whalen	21	-	19
Sr	Cactus			

*Travis White*

*Travis White*

6	David Baldonado	34	-	10
	Agua Fria	Fall	Score	
		4:13	-	

2006 AIA 4A Division I State Wrestling

Weight Class 140lb

Consolation

16	BYE				
		165			

8	Dickerson, Layton	16	-	19
So	Amphi	Fall	Score	
		BYE	-	

8	Dickerson, Layton	15	-	19
So	Amphi			

249				
-----	--	--	--	--

7	Kyle Clark	24	-	9
	Lake Havasu	Fall	Score	
		1:51	-	

Loser of Bout 164

7	Kyle Clark	23	-	9
	Lake Havasu			

12	May, Ryan	22	-	18
So	Cienega			

13	Josh Wolfe	27	-	11
Jr	Prescott	Fall	Score	
		3:50	-	

13	Josh Wolfe	26	-	11
Jr	Prescott			

250				
-----	--	--	--	--

3	James Eastin	31	-	6
Jr	Moon Valley	Fall	Score	
		8	-	4

Loser of Bout 163

3	James Eastin	30	-	6
Jr	Moon Valley			

14	Adam Carey	11	-	16
So	Saguaro			

11	Justin Draper	15	-	8
	Willow Canyon	Fall	Score	
		10	-	6

11	Justin Draper	14	-	8
	Willow Canyon			

251				
-----	--	--	--	--

5	Ryan Parman	15	-	4
Sr	Thunderbird	Fall	Score	
		4	-	1

Loser of Bout 162

5	Ryan Parman	14	-	4
Sr	Thunderbird			

10	Tyler Roberts	2	-	7
So	McClintock			

15	Honan, Paul	8	-	9
Fr	Canyon Del Oro	Fall	Score	
		8	-	3

15	Honan, Paul	7	-	9
Fr	Canyon Del Oro			

252				
-----	--	--	--	--

15	Honan, Paul	9	-	9
Fr	Canyon Del Oro	Fall	Score	
		8	-	6

Loser of Bout 161

9	Mark Malleo	10	-	12
Sr	Cactus			

307

3	James Eastin	32	-	6
Jr	Moon Valley	Fall	Score	
		3:50	-	

349

3	James Eastin	33	-	6
Jr	Moon Valley	Fall	Score	
		11	-	9

Loser of Bout 305

4	Doug Alexander	21	-	5
	Agua Fria			

Loser of Bout 306

2	Khau, Dan	16	-	3
Sr	Catalina			

350

5	Ryan Parman	17	-	4
Sr	Thunderbird	Fall	Score	
		6	-	2

5	Ryan Parman	16	-	4
Sr	Thunderbird	Fall	Score	
		5	-	2

377

*Mark Malleo*

3	James Eastin	34	-	6
Jr	Moon Valley	Fall	Score	
		10	-	4

4	Doug Alexander	21	-	6
	Agua Fria			

378

*Mark Malleo*

4	Doug Alexander	22	-	6
	Agua Fria	Fall	Score	
		7	-	3

2	Khau, Dan	16	-	4
Sr	Catalina			

**2006 AIA 4A Division I State Wrestling**

**Weight Class 145lb**

**Consolation**

16	BYE				
	173				

9	Michael Gartner	14	-	16
So	Greenway	Fall	Score	
		BYE	-	

9	Michael Gartner	13	-	16
So	Greenway			

253				
-----	--	--	--	--

2	Esparaza, Chris	42	-	6
Sr	Marana	Fall	Score	
		10	-	1

Loser of Bout 172

2	Esparaza, Chris	41	-	6
Sr	Marana			

12	Castillo, Carlos	23	-	6
Sr	Pueblo			

12	Castillo, Carlos	24	-	6
Sr	Pueblo	Fall	Score	
		1:59	-	

4	Job Mills	31	-	8
	Agua Fria			

254				
-----	--	--	--	--

3	Jimmy Lee	13	-	4
Jr	Apollo	Fall	Score	
		23	-	11

Loser of Bout 171

3	Jimmy Lee	12	-	4
Jr	Apollo			

14	Ochoa, Adam	17	-	16
Jr	Nogales			

14	Ochoa, Adam	18	-	16
Jr	Nogales	Fall	Score	
		Forfeit	-	

11	Tristan Tyson	14	-	7
	Copper Canyon			

255				
-----	--	--	--	--

14	Ochoa, Adam	19	-	16
Jr	Nogales	Fall	Score	
		4:31	-	

Loser of Bout 170

13	Carlton Carson	18	-	13
Sr	Moon Valley			

7	Cody Taylor	12	-	4
	Willow Canyon			

15	Michel Espinoza	10	-	18
So	McClintock	Fall	Score	
		8	-	5

15	Michel Espinoza	9	-	18
So	McClintock			

256				
-----	--	--	--	--

8	Wilton, Garrett	20	-	7
Jr	Canyon Del Oro	Fall	Score	
		5	-	2

Loser of Bout 169

8	Wilton, Garrett	19	-	7
Jr	Canyon Del Oro			

311

309

310

312

2	Esparaza, Chris	43	-	6
Sr	Marana	Fall	Score	
		7	-	2

2	Esparaza, Chris	44	-	6
Sr	Marana	Fall	Score	
		10	-	2

5	Lor, Orson	28	-	13
So	Amphi			

10	Morris, Billy	20	-	5
Jr	Catalina Foot.			

10	Morris, Billy	21	-	5
Jr	Catalina Foot.	Fall	Score	
		9	-	1

8	Wilton, Garrett	21	-	7
Jr	Canyon Del Oro	Fall	Score	
		5	-	0

2	Esparaza, Chris	43	-	6
Sr	Marana	Fall	Score	
		7	-	2

2	Esparaza, Chris	44	-	6
Sr	Marana	Fall	Score	
		10	-	2

5	Lor, Orson	28	-	13
So	Amphi			

10	Morris, Billy	20	-	5
Jr	Catalina Foot.			

10	Morris, Billy	21	-	5
Jr	Catalina Foot.	Fall	Score	
		9	-	1

8	Wilton, Garrett	21	-	7
Jr	Canyon Del Oro	Fall	Score	
		5	-	0

5	Lor, Orson	28	-	14
So	Amphi			
	380			

8	Wilton, Garrett	21	-	8
Jr	Canyon Del Oro			

*Tristan Tyson*

*Tristan Tyson*

2	Esparaza, Chris	45	-	6
Sr	Marana	Fall	Score	
		7	-	2

5	Lor, Orson	29	-	14
So	Amphi	Fall	Score	
		3	-	1

2006 AIA 4A Division I State Wrestling

Weight Class 152lb

Consolation

16	BYE				
	181				

9	Kendon Hatch	16	-	16
So	Cactus	Fall	Score	
		BYE	-	

9	Kendon Hatch	15	-	16
So	Cactus			

9	Kendon Hatch	17	-	16
So	Cactus	Fall	Score	
		4	-	1

Loser of Bout 180

10	Andy Chavez	11	-	3
	Copper Canyon			

5	Jadah Montenegro	2	-	1
	Millennium			

4	Colin Keleher	17	-	6
Jr	Chaparral	Fall	Score	
		9	-	8

4	Colin Keleher	16	-	6
Jr	Chaparral			

3	Anthony Moya	15	-	5
Fr	Moon Valley	Fall	Score	
		6	-	5

Loser of Bout 179

3	Anthony Moya	14	-	5
Fr	Moon Valley			

14	Ian Blazek	4	-	11
	Agua Fria			

11	Bobby Baker	7	-	12
Sr	Thunderbird	Fall	Score	
		2:19	-	

11	Bobby Baker	6	-	12
Sr	Thunderbird			

12	Khan, Dilwar	11	-	5
Sr	Catalina	Fall	Score	
		13	-	11

Loser of Bout 178

12	Khan, Dilwar	10	-	5
Sr	Catalina			

7	Mike Schutz	3	-	3
Jr	Saguaro			

2	Sanchez, Tony	27	-	8
Sr	Nogales	Fall	Score	
		5	-	4

2	Sanchez, Tony	26	-	8
Sr	Nogales			

2	Sanchez, Tony	28	-	8
Sr	Nogales	Fall	Score	
		9	-	7

Loser of Bout 177

8	Homer, Brandon	12	-	10
Jr	Cienega			

315

3	Anthony Moya	16	-	5
Fr	Moon Valley	Fall	Score	
		11	-	0

353

13	Joey Martin	15	-	16
Sr	Prescott	Fall	Score	
		3:39	-	

Loser of Bout 313

13	Joey Martin	14	-	16
Sr	Prescott			

Loser of Bout 314

15	Garcia, Mathew	36	-	14
Sr	Pueblo			

381

*Thunderbird*

15	Garcia, Mathew	38	-	14
Sr	Pueblo	Fall	Score	
		2:16	-	

354

15	Garcia, Mathew	37	-	14
Sr	Pueblo	Fall	Score	
		9	-	2

2	Sanchez, Tony	29	-	8
Sr	Nogales	Fall	Score	
		11	-	1

3	Anthony Moya	16	-	6
Fr	Moon Valley			

382

*Thunderbird*

2	Sanchez, Tony	30	-	9
Sr	Nogales	Fall	Score	
		4	-	2

2	Sanchez, Tony	29	-	9
Sr	Nogales			

**2006 AIA 4A Division I State Wrestling**

**Weight Class 160lb**

**Consolation**

16	BYE				
189					

9	Luis Guerra	15	-	13
So	Independence	Fall	Score	
		BYE		-

9	Luis Guerra	14	-	13
So	Independence			

261				
-----	--	--	--	--

9	Luis Guerra	16	-	13
So	Independence	Fall	Score	
		Default		-

Loser of Bout 188

10	Lowen Sniff	15	-	9
Sr	Saguaro			

5	Adam Cherrington	17	-	11
So	Pinnacle			

5	Adam Cherrington	18	-	11
So	Pinnacle	Fall	Score	
		10		0

13	Jacob Jarvis	17	-	9
Fr	Prescott			

262				
-----	--	--	--	--

5	Adam Cherrington	19	-	11
So	Pinnacle	Fall	Score	
		2:50		-

Loser of Bout 187

6	Pat Marshall	22	-	15
	Willow Canyon			

14	Keaton Benson	8	-	13
Sr	Thunderbird			

11	Gudeman, Brock	14	-	10
So	Cienega	Fall	Score	
		4		3

11	Gudeman, Brock	13	-	10
So	Cienega			

263				
-----	--	--	--	--

4	Martinez, Fernando	24	-	11
Jr	Nogales	Fall	Score	
		3		2

Loser of Bout 186

4	Martinez, Fernando	23	-	11
Jr	Nogales			

7	Morales, Zoar	19	-	13
So	Catalina			

7	Morales, Zoar	20	-	13
So	Catalina	Fall	Score	
		17		1

15	Tony Ventura	17	-	12
	Agua Fria			

264				
-----	--	--	--	--

8	Goodman, Jacob	25	-	10
Sr	Sabino	Fall	Score	
		2:16		-

Loser of Bout 185

8	Goodman, Jacob	24	-	10
Sr	Sabino			

319

355

Loser of Bout 317

1	Brennen Spratte	24	-	3
	Lake Havasu			

Loser of Bout 318

3	Eric Manoogian	14	-	5
Sr	Moon Valley			

356

4	Martinez, Fernando	25	-	11
Jr	Nogales	Fall	Score	
		5		4

320

383

1	Brennen Spratte	25	-	3
	Lake Havasu	Fall	Score	
		2:21		-

383

*Thomas Delance*

1	Brennen Spratte	26	-	3
	Lake Havasu	Fall	Score	
		1:39		-

3	Eric Manoogian	15	-	5
Sr	Moon Valley	Fall	Score	
		6		5

5	Adam Cherrington	20	-	12
So	Pinnacle			

4	Martinez, Fernando	25	-	12
Jr	Nogales			

*Thomas Delance*

4	Martinez, Fernando	26	-	12
Jr	Nogales	Fall	Score	
		6		5

2006 AIA 4A Division I State Wrestling

Weight Class 171lb

Consolation

16	BYE				
		197			

8	Belding, Ryab	14	-	6
Sr	Marana	Fall	Score	
		BYE	-	

8	Belding, Ryab	13	-	6
Sr	Marana			

265				
-----	--	--	--	--

10	Sullivan, Justin	27	-	12
Jr	Cienega	Fall	Score	
		10	-	3

Loser of Bout 196

10	Sullivan, Justin	26	-	12
Jr	Cienega			

5	Alentado, Vince	14	-	12
Jr	Catalina Foot.			

5	Alentado, Vince	15	-	12
Jr	Catalina Foot.	Fall	Score	
		4:12	-	

4	Nick Caporrimo	18	-	7
	Millennium			

266				
-----	--	--	--	--

5	Alentado, Vince	16	-	12
Jr	Catalina Foot.	Fall	Score	
		Default	-	

Loser of Bout 195

3	Sean Land	27	-	9
So	Pinnacle			

323

5	Alentado, Vince	17	-	12
Jr	Catalina Foot.	Fall	Score	
		6	-	5

357

12	Lopez, Robert	35	-	9
Jr	Pueblo	Fall	Score	
		7	-	6

Loser of Bout 321

12	Lopez, Robert	34	-	9
Jr	Pueblo			

*Thunderbird*

14	Marrufo, Josh	23	-	13
Jr	Sahuaro			

14	Marrufo, Josh	24	-	13
Jr	Sahuaro	Fall	Score	
		19	-	6

11	Johnny Cordova	8	-	11
	Copper Canyon			

267				
-----	--	--	--	--

13	Robert Slaughter	25	-	11
Sr	McClintock	Fall	Score	
		2:12	-	

Loser of Bout 322

6	Adam Webster	14	-	4
Sr	Greenway			

385

6	Adam Webster	16	-	4
Sr	Greenway	Fall	Score	
		3:44	-	

Loser of Bout 194

13	Robert Slaughter	24	-	11
Sr	McClintock			

7	Eric Burger	31	-	10
	Agua Fria			

7	Eric Burger	32	-	10
	Agua Fria	Fall	Score	
		Default	-	

15	Ben Monarrez	11	-	16
Fr	Cactus			

268				
-----	--	--	--	--

9	Eric Force	24	-	8
Sr	Thunderbird	Fall	Score	
		3	-	2

324

9	Eric Force	25	-	8
Sr	Thunderbird	Fall	Score	
		5	-	3

6	Adam Webster	15	-	4
Sr	Greenway	Fall	Score	
		10	-	3

Loser of Bout 193

9	Eric Force	23	-	8
Sr	Thunderbird			

5	Alentado, Vince	17	-	13
Jr	Catalina Foot.			
		3:06		

*Thunderbird*

5	Alentado, Vince	18	-	13
Jr	Catalina Foot.	Fall	Score	
		5	-	1

2006 AIA 4A Division I State Wrestling

Weight Class 189lb

Consolation

16	BYE				
	205				

8	Roy Horstman	4	-	8
	Lake Havasu	Fall	Score	
		BYE	-	

8	Roy Horstman	3	-	8
	Lake Havasu			

269				
-----	--	--	--	--

2	George Espinoza	34	-	8
	Agua Fria	Fall	Score	
		1:27	-	

Loser of Bout 204

2	George Espinoza	33	-	8
	Agua Fria			

12	Johnny Coraso	10	-	13
	Millennium			
	206			

4	Yribe, Mario	30	-	11
	Jr Pueblo	Fall	Score	
		8	-	2

4	Yribe, Mario	29	-	11
	Jr Pueblo			

270				
-----	--	--	--	--

4	Yribe, Mario	31	-	11
	Jr Pueblo	Fall	Score	
		1:31	-	

Loser of Bout 203

6	Eric Johnson	10	-	8
	Sr Pinnacle			

14	Bryant Green	18	-	9
	Jr Apollo			
	207			

14	Bryant Green	19	-	9
	Jr Apollo	Fall	Score	
		0:47	-	

11	Short, Michael	22	-	17
	So Ironwood Rdg.			

271				
-----	--	--	--	--

5	Justin Busto	19	-	11
	Jr Greenway	Fall	Score	
		8	-	7

Loser of Bout 202

5	Justin Busto	18	-	11
	Jr Greenway			

10	Josh Martinez	24	-	12
	Sr Prescott			
	208			

10	Josh Martinez	25	-	12
	Sr Prescott	Fall	Score	
		2:25	-	

15	Koree Simpson	3	-	9
	Jr McClintock			

272				
-----	--	--	--	--

10	Josh Martinez	26	-	12
	Sr Prescott	Fall	Score	
		3:36	-	

Loser of Bout 201

9	Borbon, Jeremy	20	-	10
	Sr Catalina			

327				
-----	--	--	--	--

4	Yribe, Mario	32	-	11
	Jr Pueblo	Fall	Score	
		2:11	-	

359				
-----	--	--	--	--

Loser of Bout 325

13	Maestas, Mike	32	-	10
	Jr Amphi			

Loser of Bout 326

7	Moreno, Michael	30	-	14
	So Marana			

360				
-----	--	--	--	--

5	Justin Busto	20	-	11
	Jr Greenway	Fall	Score	
		9	-	4

13	Maestas, Mike	33	-	10
	Jr Amphi	Fall	Score	
		4:42	-	

387				
-----	--	--	--	--

*Travis Wallace*

13	Maestas, Mike	34	-	10
	Jr Amphi	Fall	Score	
		3	-	1

7	Moreno, Michael	31	-	14
	So Marana	Fall	Score	
		3	-	1

4	Yribe, Mario	32	-	12
	Jr Pueblo			
	388			

*Travis Wallace*

5	Justin Busto	20	-	12
	Jr Greenway			

5	Justin Busto	21	-	12
	Jr Greenway	Fall	Score	
		6	-	4



2006 AIA 4A Division I State Wrestling

Weight Class 215lb

Consolation

16	BYE				
	213				
9	Tim Glover	12	-	16	
Sr	McClintock				

9	Tim Glover	13	-	16	
Sr	McClintock	Fall	Score		
		BYE	-		

9	Tim Glover	12	-	16	
Sr	McClintock				

273					
-----	--	--	--	--	--

7	Santamaria, Jesus	27	-	15	
Sr	Pueblo	Fall	Score		
		3:39	-		

Loser of Bout 212

7	Santamaria, Jesus	26	-	15	
Sr	Pueblo				

5	John Strawther	11	-	6	
	Millennium				
	214				

5	John Strawther	12	-	6	
	Millennium	Fall	Score		
		1:58	-		

13	Omar Khalil	20	-	9	
Sr	Saguaro				

274					
-----	--	--	--	--	--

6	Jose Munoz	26	-	9	
Sr	Moon Valley	Fall	Score		
		1:13	-		

Loser of Bout 211

6	Jose Munoz	25	-	9	
Sr	Moon Valley				

14	Mike Ligouri-Reid	13	-	20	
	Willow Canyon				
	215				

14	Mike Ligouri-Reid	14	-	20	
	Willow Canyon	Fall	Score		
		6	-	3	

11	Nichols, James	11	-	9	
So	Canyon Del Oro				

275					
-----	--	--	--	--	--

12	Grijalva, Frank	18	-	7	
Sr	Nogales	Fall	Score		
		1:40	-		

Loser of Bout 210

12	Grijalva, Frank	17	-	7	
Sr	Nogales				

10	Edgar Patino	13	-	13	
	Lake Havasu				
	216				

15	Nick Thurman	17	-	11	
Jr	Apollo	Fall	Score		
		2:38	-		

15	Nick Thurman	16	-	11	
Jr	Apollo				

276					
-----	--	--	--	--	--

8	Allen, Carlos	14	-	6	
Sr	Catalina	Fall	Score		
		2:11	-		

Loser of Bout 209

8	Allen, Carlos	13	-	6	
Sr	Catalina				

331					
-----	--	--	--	--	--

7	Santamaria, Jesus	28	-	15	
Sr	Pueblo	Fall	Score		
		4	-	1	

361					
-----	--	--	--	--	--

7	Santamaria, Jesus	28	-	15	
Sr	Pueblo	Fall	Score		
		4	-	1	

361					
-----	--	--	--	--	--

6	Jose Munoz	26	-	9	
Sr	Moon Valley	Fall	Score		
		1:13	-		

329					
-----	--	--	--	--	--

4	Reichert, Eric	16	-	6	
So	Ironwood Rdg.				

339					
-----	--	--	--	--	--

4	Reichert, Eric	16	-	6	
So	Ironwood Rdg.				

330					
-----	--	--	--	--	--

3	Ian Smith	10	-	3	
Jr	Thunderbird				

362					
-----	--	--	--	--	--

3	Ian Smith	11	-	3	
Jr	Thunderbird	Fall	Score		
		5	-	4	

362					
-----	--	--	--	--	--

8	Allen, Carlos	15	-	6	
Sr	Catalina	Fall	Score		
		Default	-		

332					
-----	--	--	--	--	--

8	Allen, Carlos	15	-	6	
Sr	Catalina	Fall	Score		
		Default	-		

332					
-----	--	--	--	--	--

8	Allen, Carlos	14	-	6	
Sr	Catalina	Fall	Score		
		2:11	-		

332					
-----	--	--	--	--	--

7	Santamaria, Jesus	28	-	16	
Sr	Pueblo				
	390				

8	Allen, Carlos	15	-	7	
Sr	Catalina				

4	Reichert, Eric	17	-	6	
So	Ironwood Rdg.	Fall	Score		
		5	-	4	

389					
-----	--	--	--	--	--

4	Reichert, Eric	16	-	6	
So	Ironwood Rdg.				

389					
-----	--	--	--	--	--

3	Ian Smith	10	-	3	
Jr	Thunderbird				

3	Ian Smith	11	-	3	
Jr	Thunderbird	Fall	Score		
		5	-	4	

3	Ian Smith	11	-	3	
Jr	Thunderbird	Fall	Score		
		5	-	4	

3	Ian Smith	11	-	3	
Jr	Thunderbird	Fall	Score		
		5	-	4	

3	Ian Smith	11	-	3	
Jr	Thunderbird	Fall	Score		
		5	-	4	

8	Allen, Carlos	15	-	6	
Sr	Catalina	Fall	Score		
		Default	-		

8	Allen, Carlos	15	-	6	
Sr	Catalina	Fall	Score		
		Default	-		

8	Allen, Carlos	15	-	6	
Sr	Catalina	Fall	Score		
		Default	-		

7	Santamaria, Jesus	28	-	16	
Sr	Pueblo				
	390				

7	Santamaria, Jesus	29	-	16	
Sr	Pueblo	Fall	Score		
		10	-	5	

7	Santamaria, Jesus	29	-	16	
Sr	Pueblo	Fall	Score		
		10	-	5	

8	Allen, Carlos	15	-	7	
Sr	Catalina				

*Thunderbird*

*Thunderbird*

**2006 AIA 4A Division I State Wrestling**

**Weight Class**

**Consolation**

16	BYE			
221				

9	Brown, Cliff	13	-	15
So	Canyon Del Oro	Fall	Score	
		BYE	-	

9	Brown, Cliff	12	-	15
So	Canyon Del Oro			

277				
-----	--	--	--	--

Loser of Bout 220

7	Jake Stucky	30	-	8
	Agua Fria			

7	Jake Stucky	31	-	8
	Agua Fria	Fall	Score	
		0:41	-	

5	Mike Hernandez	18	-	15
Jr	McClintock			

5	Mike Hernandez	19	-	15
Jr	McClintock	Fall	Score	
		4	-	2

13	Coroando, Edgar	23	-	14
Sr	Pueblo			

278				
-----	--	--	--	--

Loser of Bout 219

3	Petty, Mar-Kell	31	-	5
Sr	Sabino			

335				
-----	--	--	--	--

3	Petty, Mar-Kell	33	-	5
Sr	Sabino	Fall	Score	
		2:43	-	

363				
-----	--	--	--	--

Loser of Bout 333

4	Chris Green	27	-	5
	Millennium			

Loser of Bout 334

6	Sobarzo, Marshal	29	-	9
Jr	Nogales			

14	Thomas Arigi	6	-	11
Sr	Pinnacle			

11	Guillermo Loyola	17	-	13
	Willow Canyon	Fall	Score	
		2:33	-	

11	Guillermo Loyola	16	-	13
	Willow Canyon			

Loser of Bout 218

12	Cory Cavazos	19	-	12
Jr	Apollo			

12	Cory Cavazos	20	-	12
Jr	Apollo	Fall	Score	
		3:53	-	

364				
-----	--	--	--	--

6	Sobarzo, Marshal	30	-	9
Jr	Nogales	Fall	Score	
		0:37	-	

10	Pat Sparks	1	-	3
Sr	Thunderbird			

15	Romero, Robert	31	-	11
Sr	Amphi	Fall	Score	
		1:31	-	

15	Romero, Robert	30	-	11
Sr	Amphi			

Loser of Bout 217

1	Miranda-Fitzgerald, Sean	29	-	1
Sr	Catalina			

336				
-----	--	--	--	--

15	Romero, Robert	33	-	11
Sr	Amphi	Fall	Score	
		13	-	2

15	Romero, Robert	32	-	11
Sr	Amphi	Fall	Score	
		3	-	2

4	Chris Green	28	-	5
	Millennium	Fall	Score	
		8	-	3

*Thomas Arigi*

391				
-----	--	--	--	--

4	Chris Green	29	-	5
	Millennium	Fall	Score	
		2:15	-	

15	Romero, Robert	33	-	11
Sr	Amphi	Fall	Score	
		13	-	2

3	Petty, Mar-Kell	33	-	6
Sr	Sabino			

*Pat Sparks*

392				
-----	--	--	--	--

15	Romero, Robert	34	-	12
Sr	Amphi	Fall	Score	
		4	-	1

## 2005-2006 4A Div. II State Wrestling Tournament after Championship Finals

Place	Total	SCHOOL	Coach	Wt 103	Wt 112	Wt 119	Wt 125	Wt 130	Wt 135	Wt 140	Wt 145	Wt 152	Wt 160	Wt 171	Wt 189	Wt 215	Wt HWt	Total
1	221	Mingus		29		14	22	28	24	26	10	14	9	26	7	4	8	221
2	135.5	Sunnyslope		11	12		3		17		22	22	7	18.5	20		3	135.5
3	125	Buckeye		18		8	12	3	3	9	15		19	19	4		15	125
4	117.5	Apache Jct.		1	3.5	25	5		9	21.5	15.5					17	20	117.5
4	117.5	Queen Creek							14	21.5	4	3	18	22	25	6	4	117.5
6	89	Tempe		13	21	1	9			4.5		23.5	17					89
7	88.5	Cholla						22		14		2		11	16	23.5		88.5
8	87	Mohave	-1	7		12	24	14		1							30	87
9	79	Rio Rico		19		17			4		26	9		4				79
10	76.5	Coconino		4	1			12	19				3	12	21.5	4		76.5
11	75.5	Higley				3	7	3			1	14	11	3	16	10.5	7	75.5
12	68	Douglas			4			1	7				24	3	3	26		68
13	62	Desert View			19.5	1		4					19.5				18	62
14	57.5	Desert Edge			26						10.5		3	5	6		7	57.5
15	54.5	Washington		3	4		3					3			12.5	9	20	54.5
16	43.5	Cortez					1		14.5				5			23		43.5
17	36	Dysart			12			13		3	6	2						36
18	33	Page					22							7		4		33
19	31.5	Coronado		2	10.5			16	3									31.5
20	30	Flagstaff			2	20		2	5	2		-1						30
21	25	Notre Dame					10			11		4						25
22	11.5	Cactus Shad.				4.5										4	3	11.5
23	8	Palo Verde									5		3					8
24	7	Bradshaw Mtn.								7								7
25	6	Glendale										3			3			6
26	5	Santa Rita				5												5
27	3	Sinagua									3							3
28	0	Arcadia																0
28	0	Chinle																0
Place	Total	SCHOOL	Coach	Wt 103	Wt 112	Wt 119	Wt 125	Wt 130	Wt 135	Wt 140	Wt 145	Wt 152	Wt 160	Wt 171	Wt 189	Wt 215	Wt HWt	Total

**2006 AIA 4A Division I State Wrestling**

**Weight Class**

**103lb**

1	SHANE DALY	36	-	6
FR	MOHAVE			
	1			

1	SHANE DALY	36	-	6
FR	MOHAVE	Fall	Score	
	Bye			

16	BYE			
----	-----	--	--	--

113

9	BYE			
	2			

8	Crockwell, Josh	5	-	2
Fr	Desert View	Fall	Score	
	Bye			

8	Crockwell, Josh	4	-	2
Fr	Desert View			

281

5	Josh Chang	6	-	0
Fr	Mingus			
	3			

5	Josh Chang	7	-	0
Fr	Mingus	Fall	Score	
	1:38			

12	Gomez, Victor	15	-	17
Fr	Douglas			

114

13	Fabian Parra Jr	23	-	9
	Sunnyslope			
	4			

4	Jacob Villa	25	-	11
So	Tempe	Fall	Score	
	5:58			

4	Jacob Villa	24	-	11
So	Tempe			

1	SHANE DALY	37	-	6
FR	MOHAVE	Fall	Score	
	10			4

5	Josh Chang	8	-	0
Fr	Mingus	Fall	Score	
	1:23			

393

3	Marcus Williams	23	-	8
	Washington			
	5			

3	Marcus Williams	24	-	8
	Washington	Fall	Score	
	8			0

14	Chanty Fowler	19	-	15
Fr	Page			

115

11	Nate Galvan	28	-	10
So	Apache Jct.			
	6			

6	ZAYNE KARSTETTER	32	-	8
FR	BUCKEYE	Fall	Score	
	5			2

6	ZAYNE KARSTETTER	31	-	8
FR	BUCKEYE			

282

7	Ben Peterson	13	-	16
Fr	Coronado			
	7			

10	Shawna Isabell	15	-	10
Fr	Coconino	Fall	Score	
	5:14			

10	Shawna Isabell	14	-	10
Fr	Coconino			

116

15	JOHNNY SALDANA	6	-	11
0	DESERT EDGE			
	8			

2	Esteban, Celis	11	-	3
So	Rio Rico	Fall	Score	
	0:58			

2	Esteban, Celis	10	-	3
So	Rio Rico			

6	ZAYNE KARSTETTER	33	-	8
FR	BUCKEYE	Fall	Score	
	2			1

5	Josh Chang	9	-	0
Fr	Mingus	Fall	Score	
	1:08			

6	ZAYNE KARSTETTER	34	-	8
FR	BUCKEYE	Fall	Score	
	5			1

5	Josh Chang			
Fr	Mingus	Fall	Score	
		15		- 2
	Overall Record	10		- 0

**2006 AIA 4A Division I State Wrestling**

**Weight Class**

**112lb**

1	Gabe Gomez	24	-	4
Sr	Tempe			
	9			
16	BYE			
9	Andrade, Ali	15	-	10
Fr	Douglas			
	10			
8	TROY NAHRGANG	24	-	13
FR	BUCKEYE			
5	Adam Ulibarri	18	-	17
Jr	Coconino			
	11			
12	JEREMY VALLEJO	26	-	12
	DYSART			
13	McDaniel, Bryce	21	-	10
Sr	Cholla			
	12			
4	Francisco Mora	16	-	7
Sr	Sunnyslope			
3	Garcia, Matt	36	-	3
Sr	Desert View			
	13			
14	Nick Sepulveda	12	-	8
Jr	Flagstaff			
11	Riley O'Neal	10	-	12
Jr	Cactus Shad.			
	14			
6	Travis Huff	28	-	4
So	Coronado			
7	Raymond Camacho	18	-	12
	Washington			
	15			
10	Phil Williams	20	-	18
Fr	Mingus			
15	Kyle McMinn	25	-	15
So	Apache Jct.			
	16			
2	THERON APODACA	21	-	1
SO	DESERT EDGE			

1	Gabe Gomez	24	-	4
Sr	Tempe			
	Fall			
	Score			
	Bye			
	-			
	121			
1	Gabe Gomez	25	-	4
Sr	Tempe			
	Fall			
	Score			
	16			
	-			
	0			
9	Andrade, Ali	16	-	10
Fr	Douglas			
	Fall			
	Score			
	5:56			
	-			
	285			
1	Gabe Gomez	26	-	4
Sr	Tempe			
	Fall			
	Score			
	21			
	-			
	4			
12	JEREMY VALLEJO	27	-	12
	DYSART			
	Fall			
	Score			
	14			
	-			
	4			
	122			
4	Francisco Mora	18	-	7
Sr	Sunnyslope			
	Fall			
	Score			
	9			
	-			
	7			
	394			
4	Francisco Mora	17	-	7
Sr	Sunnyslope			
	Fall			
	Score			
	9			
	-			
	2			
3	Garcia, Matt	37	-	3
Sr	Desert View			
	Fall			
	Score			
	1:14			
	-			
	123			
3	Garcia, Matt	38	-	3
Sr	Desert View			
	Fall			
	Score			
	5:48			
	-			
	286			
6	Travis Huff	29	-	4
So	Coronado			
	Fall			
	Score			
	1:30			
	-			
	2			
2	THERON APODACA	22	-	1
SO	DESERT EDGE			
	Fall			
	Score			
	0:53			
	-			
	2			
2	THERON APODACA	23	-	1
SO	DESERT EDGE			
	Fall			
	Score			
	1:27			
	-			
	2			
2	THERON APODACA	24	-	1
SO	DESERT EDGE			
	Fall			
	Score			
	7			
	-			
	2			

2	<b>Theron Apodaca</b>			
So	Desert Edge			
	Fall			
	Score			
	12			
	-			
	9			
	Overall Record			
	25			
	-			
	1			
2	THERON APODACA	24	-	1
SO	DESERT EDGE			
	Fall			
	Score			
	7			
	-			
	2			

**2006 AIA 4A Division I State Wrestling**

**Weight Class**

**119lb**

1	Mike Armagost	37	-	2
Sr	Apache Jct.			
	<b>17</b>			
16	BYE			

1	Mike Armagost	37	-	2
Sr	Apache Jct.	<b>Fall</b>	<b>Score</b>	
	Bye			

9	Roman Isabell	11	-	16
So	Coconino			
	<b>18</b>			
8	TROY GANLEY	33	-	7
SO	BUCKEYE			

8	TROY GANLEY	34	-	7
SO	BUCKEYE	<b>Fall</b>	<b>Score</b>	
		21	-	10

5	Zach O'Kane	17	-	10
Jr	Cactus Shad.			
	<b>19</b>			
12	TERRENCE HUSKON	4	-	6
FR	DESERT EDGE			

5	Zach O'Kane	18	-	10
Jr	Cactus Shad.	<b>Fall</b>	<b>Score</b>	
		15	-	0

13	Wes Lymangrover	25	-	14
Fr	Mingus			
	<b>20</b>			
4	Mesa, Valentin	8	-	4
So	Desert View			

13	Wes Lymangrover	26	-	14
Fr	Mingus	<b>Fall</b>	<b>Score</b>	
		11	-	5

3	Cameron Alvarado	34	-	7
Jr	Flagstaff			
	<b>21</b>			
14	Boris Suleymanov	5	-	7
	Washington			

3	Cameron Alvarado	35	-	7
Jr	Flagstaff	<b>Fall</b>	<b>Score</b>	
		2:42	-	

11	Sean, Bryan	27	-	6
Jr	Santa Rita			
	<b>22</b>			
6	Long Le	10	-	10
Sr	Higley			

11	Sean, Bryan	28	-	6
Jr	Santa Rita	<b>Fall</b>	<b>Score</b>	
		3:36	-	

7	Clapeck, JJ	18	-	3
Jr	Rio Rico			
	<b>23</b>			
10	Sam Houston	12	-	10
So	Sunnyslope			

7	Clapeck, JJ	19	-	3
Jr	Rio Rico	<b>Fall</b>	<b>Score</b>	
		10	-	6

15	Tony Rodriguez	19	-	12
So	Tempe			
	<b>24</b>			
2	JARED HIGGINS	40	-	5
JR	MOHAVE			

2	JARED HIGGINS	41	-	5
JR	MOHAVE	<b>Fall</b>	<b>Score</b>	
		1:40	-	

1	Mike Armagost	38	-	2
Sr	Apache Jct.	<b>Fall</b>	<b>Score</b>	
		4:56	-	

1	Mike Armagost	39	-	2
Sr	Apache Jct.	<b>Fall</b>	<b>Score</b>	
		11	-	3

13	Wes Lymangrover	27	-	14
Fr	Mingus	<b>Fall</b>	<b>Score</b>	
		4:33	-	

1	Mike Armagost			
Sr	Apache Jct.	<b>Fall</b>	<b>Score</b>	
		7	-	2
		Overall Record	40	-
				2

3	Cameron Alvarado	36	-	7
Jr	Flagstaff	<b>Fall</b>	<b>Score</b>	
		7	-	1

3	Cameron Alvarado	37	-	7
Jr	Flagstaff	<b>Fall</b>	<b>Score</b>	
		3	-	2

7	Clapeck, JJ	20	-	3
Jr	Rio Rico	<b>Fall</b>	<b>Score</b>	
		1:18	-	

129

289

130

395

290

132

**2006 AIA 4A Division I State Wrestling**

**Weight Class**

**125lb**

1	DONALD TEJADA	38	-	6
SR	MOHAVE			
	25			
16	BYE			

1	DONALD TEJADA	38	-	6
SR	MOHAVE	Fall	Score	
		Bye	-	

9	Taylor McArthur	13	-	14
So	Higley			
	26			

9	Taylor McArthur	14	-	14
So	Higley	Fall	Score	

8	Harrie Baker	20	-	14
Sr	Flagstaff			

		2:50	-	
--	--	------	---	--

5	Sandoval, Victor	2	-	0
So	Desert View			
	27			

12	Brian Lymangrover	11	-	9
Jr	Mingus	Fall	Score	
		0:54	-	

12	Brian Lymangrover	10	-	9
Jr	Mingus			

12	Brian Lymangrover	12	-	9
Jr	Mingus	Fall	Score	
		5:05	-	

13	Christian Espinoza	11	-	7
Jr	Tempe			
	28			

13	Christian Espinoza	12	-	7
Jr	Tempe	Fall	Score	
		8	-	6

4	Thomas Colyar	17	-	11
	Washington			

3	Alex Freed	15	-	7
Jr	Apache Jct.			
	29			

3	Alex Freed	16	-	7
Jr	Apache Jct.	Fall	Score	
		1:16	-	

14	Beeston, Steven	8	-	13
Fr	Santa Rita			

11	Mylo Parra	9	-	9
Sr	Sunnyslope			
	30			

6	JEREMY SCHWIESOW	18	-	3
SO	BUCKEYE	Fall	Score	
		2	-	1

6	JEREMY SCHWIESOW	17	-	3
SO	BUCKEYE			

7	Enrico Fabiani	17	-	4
Jr	Notre Dame			
	31			

7	Enrico Fabiani	18	-	4
Jr	Notre Dame	Fall	Score	
		1:33	-	

10	Fraijo, Rocky	7	-	7
Jr	Douglas			

15	MIKE RUHE	7	-	13
	CORTEZ			
	32			

2	Shane Fredrick	31	-	5
Sr	Page	Fall	Score	
		2:44	-	

2	Shane Fredrick	30	-	5
Sr	Page			

1	DONALD TEJADA	39	-	6
SR	MOHAVE	Fall	Score	
		3:42	-	

9	Taylor McArthur	14	-	14
So	Higley	Fall	Score	
		2:50	-	

1	DONALD TEJADA	40	-	6
SR	MOHAVE	Fall	Score	
		6	-	4

12	Brian Lymangrover	11	-	9
Jr	Mingus	Fall	Score	
		0:54	-	

12	Brian Lymangrover	12	-	9
Jr	Mingus	Fall	Score	
		5:05	-	

13	Christian Espinoza	12	-	7
Jr	Tempe	Fall	Score	
		8	-	6

1	Donald Tejada				
Sr	Mohave	Fall	Score		
		10	-	6	
		Overall Record	41	-	6

6	JEREMY SCHWIESOW	19	-	3
SO	BUCKEYE	Fall	Score	
		7	-	5

6	JEREMY SCHWIESOW	18	-	3
SO	BUCKEYE	Fall	Score	
		2	-	1

2	Shane Fredrick	33	-	5
Sr	Page	Fall	Score	
		9	-	2

7	Enrico Fabiani	18	-	4
Jr	Notre Dame	Fall	Score	
		1:33	-	

2	Shane Fredrick	32	-	5
Sr	Page	Fall	Score	
		3:21	-	

2	Shane Fredrick	31	-	5
Sr	Page	Fall	Score	
		2:44	-	

**2006 AIA 4A Division I State Wrestling**

**Weight Class**

**130lb**

1	Tyler Chang	23	-	1
Jr	Mingus			
	<b>33</b>			

1	Tyler Chang	23	-	1
Jr	Mingus	<b>Fall</b>	<b>Score</b>	
		Bye	-	

16	BYE			
----	-----	--	--	--

**145**

9	Ryan Yates	16	-	18
Jr	Apache Jct.			
	<b>34</b>			

8	Ramirez, Cody	22	-	13
So	Douglas	<b>Fall</b>	<b>Score</b>	

8	Ramirez, Cody	21	-	13
So	Douglas			

1	Tyler Chang	24	-	1
Jr	Mingus	<b>Fall</b>	<b>Score</b>	
		1:07	-	

**297**

5	Jonathan Camacho	13	-	4
	Washington			
	<b>35</b>			

12	Manuel, Jose	8	-	5
So	Desert View	<b>Fall</b>	<b>Score</b>	
		3:57	-	

12	Manuel, Jose	7	-	5
So	Desert View			

**146**

13	Cris Ries	13	-	13
So	Higley			
	<b>36</b>			

4	CHRIS PUGH	38	-	7
SR	MOHAVE	<b>Fall</b>	<b>Score</b>	

4	CHRIS PUGH	37	-	7
SR	MOHAVE			

4	CHRIS PUGH	39	-	7
SR	MOHAVE	<b>Fall</b>	<b>Score</b>	
		5:41	-	

**397**

3	Ceenan Jackson	27	-	5
Sr	Coronado			
	<b>37</b>			

3	Ceenan Jackson	28	-	5
Sr	Coronado	<b>Fall</b>	<b>Score</b>	
		3:20	-	

14	Keith Howell	5	-	11
Jr	Cactus Shad.			

**147**

11	AMMON BYBEE	19	-	13
So	BUCKEYE			
	<b>38</b>			

11	AMMON BYBEE	20	-	13
So	BUCKEYE			

6	Joel Giannola	17	-	11
Fr	Flagstaff			

3	Ceenan Jackson	29	-	5
Sr	Coronado	<b>Fall</b>	<b>Score</b>	
		8	-	7

**298**

7	DANIEL CORONADO	14	-	11
	DYSART			
	<b>39</b>			

7	DANIEL CORONADO	15	-	11
	DYSART	<b>Fall</b>	<b>Score</b>	
		3:28	-	

10	Alec Schmelling	11	-	19
Jr	Sunnyslope			

**148**

15	Matt Dyer	12	-	11
Jr	Coconino			
	<b>40</b>			

2	Stienbach, TJ	30	-	4
Sr	Cholla	<b>Fall</b>	<b>Score</b>	

2	Stienbach, TJ	29	-	4
Sr	Cholla			

2	Stienbach, TJ	31	-	4
Sr	Cholla	<b>Fall</b>	<b>Score</b>	
		3:48	-	

1	Tyler Chang	25	-	1
Jr	Mingus	<b>Fall</b>	<b>Score</b>	
		17	-	1

1	Tyler Chang			
Jr	Mingus	<b>Fall</b>	<b>Score</b>	
		4:54	-	
		Overall Record	26	-
				1



**2006 AIA 4A Division I State Wrestling**

**Weight Class**

**135lb**

1 Rob Loehr 30 - 1

Sr Mingus  
41

16 BYE

1 Rob Loehr 30 - 1

Sr Mingus Fall Score  
Bye -

153

9 ANDREW PARRA 30 - 13

FR MOHAVE  
42

8 Velasco, Luis 4 - 16

Fr Rio Rico

8 Velasco, Luis 5 - 16

Fr Rio Rico Fall Score  
0:54 -

301

5 Roby Owsley 15 - 5

Jr Sunnyslope  
43

12 Rascon, Orlando 22 - 9

So Santa Rita

5 Roby Owsley 16 - 5

Jr Sunnyslope Fall Score  
0:51 -

154

13 BRYAN PETERSON 26 - 8

SR BUCKEYE  
44

4 Tod Workman 32 - 10

So Queen Creek

4 Tod Workman 33 - 10

So Queen Creek Fall Score  
11 - 9

398

3 ISSAC SELIN 29 - 5

SR CORTEZ  
45

14 Jeremy Vick 9 - 16

So Bradshaw Mtn.

3 ISSAC SELIN 30 - 5

SR CORTEZ Fall Score  
0:48 -

155

11 Danny Parado 22 - 9

So Coronado  
46

6 Jerald Lewis 25 - 11

Sr Coconino

6 Jerald Lewis 26 - 11

Sr Coconino Fall Score  
11 - 1

302

7 Traston Yates 16 - 9

Sr Apache Jct.  
47

10 Brian Colan 9 - 6

So Cactus Shad.

7 Traston Yates 17 - 9

Sr Apache Jct. Fall Score  
9 - 1

156

15 Mike Roberts 7 - 6

Sr Flagstaff  
48

2 Barroso, John Paul 22 - 3

Sr Douglas

2 Barroso, John Paul 23 - 3

Sr Douglas Fall Score  
4:30 -

1 Rob Loehr 31 - 1

Sr Mingus Fall Score  
1:19 -

4 Tod Workman 34 - 10

So Queen Creek Fall Score  
5 - 3

1 Rod Loehr 32 - 1

Sr Mingus Fall Score  
9 - 3

1 Rod Loehr

Sr Mingus Fall Score  
9 - 2

Overall Record 33 - 1

6 Jerald Lewis 27 - 11

Sr Coconino Fall Score  
11 - 6

6 Jerald Lewis 28 - 11

Sr Coconino Fall Score  
13 - 6

7 Traston Yates 18 - 9

Sr Apache Jct. Fall Score  
15 - 2

**2006 AIA 4A Division I State Wrestling**

**Weight Class**

**140lb**

1	Travis Wokasch	12	-	1
Jr	Mingus			
<b>49</b>				
16	BYE			

1	Travis Wokasch	12	-	1
Jr	Mingus	<b>Fall</b>	<b>Score</b>	
		Bye	-	

**161**

9	Nathan Selman	15	-	10
Fr	Tempe			
<b>50</b>				

9	Nathan Selman	16	-	10
Fr	Tempe	<b>Fall</b>	<b>Score</b>	

8	Miller, Mark	6	-	7
So	Rio Rico			

		17	-	2
--	--	----	---	---

**305**

5	CURTIS WRIGHT	25	-	11
JR	BUCKEYE			
<b>51</b>				

5	CURTIS WRIGHT	26	-	11
JR	BUCKEYE	<b>Fall</b>	<b>Score</b>	

12	Navarrete, Adrain	15	-	11
Jr	Douglas			

		8	-	4
--	--	---	---	---

**162**

13	Sam Harlan	29	-	8
Sr	Apache Jct.			
<b>52</b>				

4	Peter Danjczek	19	-	3
Sr	Notre Dame	<b>Fall</b>	<b>Score</b>	
		3:48	-	

4	Peter Danjczek	18	-	3
Sr	Notre Dame			

--	--	--	--	--

**399**

3	Andy Wickizer	25	-	6
Sr	Queen Creek			
<b>53</b>				

3	Andy Wickizer	26	-	6
Sr	Queen Creek	<b>Fall</b>	<b>Score</b>	

14	JOESEPH BRADSHAW	20	-	13
	DYSART			

		16	-	1
--	--	----	---	---

**163**

11	Bryce Altaffer	1	-	1
Fr	Sunnyslope			
<b>54</b>				

6	Rudy Kovac	15	-	10
Sr	Flagstaff	<b>Fall</b>	<b>Score</b>	

6	Rudy Kovac	14	-	10
Sr	Flagstaff			

		13	-	7
--	--	----	---	---

**306**

7	Danny Montoya	6	-	13
So	Bradshaw Mtn.			
<b>55</b>				

7	Danny Montoya	7	-	13
So	Bradshaw Mtn.	<b>Fall</b>	<b>Score</b>	
		1:09	-	

10	RANDY QUEEN	19	-	8
FR	MOHAVE			

--	--	--	--	--

**164**

15	Anthony Lucero	14	-	13
So	Page			
<b>56</b>				

2	Vallejo, Daniel	33	-	4
Fr	Cholla	<b>Fall</b>	<b>Score</b>	

2	Vallejo, Daniel	32	-	4
Fr	Cholla			

		8	-	4
--	--	---	---	---

1	Travis Wokasch	13	-	1
Jr	Mingus	<b>Fall</b>	<b>Score</b>	
		1:47	-	

1	Travis Wokasch	14	-	1
Jr	Mingus	<b>Fall</b>	<b>Score</b>	
		3:28	-	

5	CURTIS WRIGHT	27	-	11
JR	BUCKEYE	<b>Fall</b>	<b>Score</b>	
		8	-	6

1	Travis Wokasch			
Jr	Mingus	<b>Fall</b>	<b>Score</b>	
		7	-	1

Overall Record 15 - 1

**2006 AIA 4A Division I State Wrestling**

**Weight Class**

**145lb**

1	Jake DeVree	24	-	3
Sr	Apache Jct.			
<b>57</b>				
16	BYE			

1	Jake DeVree	24	-	3
Sr	Apache Jct.	<b>Fall</b>	<b>Score</b>	
		Bye	-	

**169**

9	Matt Delagarza	9	-	12
	Washington			
<b>58</b>				
8	SETH LOWRY	25	-	13
	DYSART			

8	SETH LOWRY	26	-	13
	DYSART	<b>Fall</b>	<b>Score</b>	
		1:28	-	

**309**

5	Adam Earls	18	-	5
Jr	Mingus			
<b>59</b>				
12	LOGAN YOUNG	21	-	4
JR	BUCKEYE			

12	LOGAN YOUNG	22	-	4
JR	BUCKEYE	<b>Fall</b>	<b>Score</b>	
		16	-	6

**170**

13	Eric Herrin	12	-	14
Sr	Bradshaw Mtn.			
<b>60</b>				
4	Copper, DeWitt	13	-	3
Jr	Rio Rico			

4	Copper, DeWitt	14	-	3
Jr	Rio Rico	<b>Fall</b>	<b>Score</b>	
		1:13	-	

**400**

3	Jason Holtgrewe	29	-	6
Sr	Sunnyslope			
<b>61</b>				
14	Ben Conklin	14	-	6
S0	Sinagua			

3	Jason Holtgrewe	30	-	6
Sr	Sunnyslope	<b>Fall</b>	<b>Score</b>	
		0:54	-	

**171**

11	Goble, Andy	18	-	10
So	Santa Rita			
<b>62</b>				
6	Cody DeGroot	32	-	13
Sr	Queen Creek			

6	Cody DeGroot	33	-	13
Sr	Queen Creek	<b>Fall</b>	<b>Score</b>	
		1:32	-	

**310**

7	Brown, Jeff	19	-	6
Sr	Palo Verde			
<b>63</b>				
10	Jared Marks	8	-	7
Jr	Coconino			

7	Brown, Jeff	20	-	6
Sr	Palo Verde	<b>Fall</b>	<b>Score</b>	
		4	-	2

**172**

15	John Zuniga	13	-	10
Jr	Higley			
<b>64</b>				
2	PAT LAHAIE	18	-	3
	DESERT EDGE			

2	PAT LAHAIE	19	-	3
	DESERT EDGE	<b>Fall</b>	<b>Score</b>	
		18	-	2

1	Jake DeVree	25	-	3
Sr	Apache Jct.	<b>Fall</b>	<b>Score</b>	
		18	-	3

4	Copper, DeWitt	15	-	3
Jr	Rio Rico	<b>Fall</b>	<b>Score</b>	
		1:59	-	

4	Copper, DeWitt	16	-	3
Jr	Rio Rico	<b>Fall</b>	<b>Score</b>	
		4	-	3

4	Cooper, DeWitt			
Jr	Rio Rico	<b>Fall</b>	<b>Score</b>	
		8	-	6
			Overtime	
	Overall Record	17	-	3

3	Jason Holtgrewe	32	-	6
Sr	Sunnyslope	<b>Fall</b>	<b>Score</b>	
		8	-	4

2	PAT LAHAIE	20	-	3
	DESERT EDGE	<b>Fall</b>	<b>Score</b>	
		6	-	0

**2006 AIA 4A Division I State Wrestling**

**Weight Class**

**152lb**

1	Sam Ciurdar	32	-	3
Jr	Sunnyslope			
	<b>65</b>			
16	BYE			
9	RYAN ESPARZA	14	-	16
	DYSART			
	<b>66</b>			
8	Jake Goddard	22	-	13
Fr	Queen Creek			
5	Palacio, Daniel	5	-	1
Sr	Desert View			
	<b>67</b>			
12	Andrew Roper	18	-	6
Sr	Higley			
13	ABRAHAM PARRA	31	-	13
FR	MOHAVE			
	<b>68</b>			
4	Cody Rader	22	-	14
Jr	Mingus			
3	TRAVIS HARDON	11	-	4
SR	GLENDALE			
	<b>69</b>			
14	Kingsford, David	13	-	9
Fr	Rio Rico			
11	Keith Ryan	12	-	16
Jr	Flagstaff			
	<b>70</b>			
6	Joe Mlachak	8	-	8
Jr	Notre Dame			
7	Tyson Bigman	2	-	1
Jr	Page			
	<b>71</b>			
10	Enriquez, Luis	19	-	16
Fr	Cholla			
15	David Romero	5	-	1
	Washington			
	<b>72</b>			
2	Steven Whittle	28	-	3
Sr	Tempe			

1	Sam Ciurdar	32	-	3
Jr	Sunnyslope			
	<b>Fall</b>			
	<b>Score</b>			
	Bye			
	-			

**177**

1	Sam Ciurdar	33	-	3
Jr	Sunnyslope			
	<b>Fall</b>			
	<b>Score</b>			
	4			
	-			
	2			

8	Jake Goddard	23	-	13
Fr	Queen Creek			
	<b>Fall</b>			
	<b>Score</b>			
	8			
	-			
	6			

**313**

5	Palacio, Daniel	6	-	1
Sr	Desert View			
	<b>Fall</b>			
	<b>Score</b>			
	9			
	-			
	0			

**178**

4	Cody Rader	23	-	14
Jr	Mingus			
	<b>Fall</b>			
	<b>Score</b>			
	5:50			
	-			
	-			

4	Cody Rader	24	-	14
Jr	Mingus			
	<b>Fall</b>			
	<b>Score</b>			
	2			
	-			
	1			

**401**

1	Sam Ciurdar	34	-	3
Jr	Sunnyslope			
	<b>Fall</b>			
	<b>Score</b>			
	9			
	-			
	6			

1	Sam Ciurdar			
Jr	Sunnyslope			
	<b>Fall</b>			
	<b>Score</b>			
	8			
	-			
	6			
	Overall Record	35		
		-		
		3		

14	Kingsford, David	14	-	9
Fr	Rio Rico			
	<b>Fall</b>			
	<b>Score</b>			
	13			
	-			
	12			

**179**

6	Joe Mlachak	9	-	8
Jr	Notre Dame			
	<b>Fall</b>			
	<b>Score</b>			
	0:43			
	-			

14	Kingsford, David	15	-	9
Fr	Rio Rico			
	<b>Fall</b>			
	<b>Score</b>			
	3:39			
	-			

**314**

10	Enriquez, Luis	20	-	16
Fr	Cholla			
	<b>Fall</b>			
	<b>Score</b>			
	9			
	-			
	5			

**180**

2	Steven Whittle	29	-	3
Sr	Tempe			
	<b>Fall</b>			
	<b>Score</b>			
	1:50			
	-			

2	Steven Whittle	30	-	3
Sr	Tempe			
	<b>Fall</b>			
	<b>Score</b>			
	4:33			
	-			

2	Steven Whittle	31	-	3
Sr	Tempe			
	<b>Fall</b>			
	<b>Score</b>			
	17			
	-			
	2			

**2006 AIA 4A Division I State Wrestling**

**Weight Class**

**160lb**

1	Ramirez, Austin	33	-	2
Sr	Douglas			
	73			

1	Ramirez, Austin	33	-	2
Sr	Douglas	Fall	Score	
	Bye			

9	JACOB HALL	19	-	12
	CORTEZ			
	74			

9	JACOB HALL	20	-	12
	CORTEZ	Fall	Score	

8	Earl Langendorf	3	-	5
	Washington			

		3:58		

5	Rowdy Scott	9	-	9
So	Mingus			
	75			

5	Rowdy Scott	10	-	9
So	Mingus	Fall	Score	

12	Chance Meeks	8	-	12
So	Notre Dame			

		2:49		

13	TONY MORNEAU	16	-	2
SR	DESERT EDGE			
	76			

4	Kyle Lebtich	20	-	5
Sr	Higley	Fall	Score	

4	Kyle Lebtich	19	-	5
Sr	Higley			

		4:46		

3	TREY NAHRGANG	27	-	7
SO	BUCKEYE			
	77			

3	TREY NAHRGANG	28	-	7
SO	BUCKEYE	Fall	Score	

14	Soto FORFEIT	9	-	8
So	Flagstaff			

		Forfeit		

11	Angel Rodriguez	29	-	10
Sr	Tempe			
	78			

11	Angel Rodriguez	30	-	10
Sr	Tempe	Fall	Score	

6	Hunt, Kevin	11	-	10
Sr	Palo Verde			

		1:37		

7	Roberto Villalpando	29	-	7
Sr	Queen Creek			
	79			

7	Roberto Villalpando	30	-	7
Sr	Queen Creek	Fall	Score	

10	Mitchell Buchanan	11	-	13
Sr	Coconino			

		8	-	1

15	Valdez, Mario	5	-	12
Fr	Rio Rico			
	80			

2	Zhani Doko	27	-	6
Jr	Sunnyslope	Fall	Score	

2	Zhani Doko	26	-	6
Jr	Sunnyslope			

		1:32		

1	Ramirez, Austin	34	-	2
Sr	Douglas	Fall	Score	
		1:28		

1	Ramirez, Austin	35	-	2
Sr	Douglas	Fall	Score	
		6	-	0

5	Rowdy Scott	11	-	9
So	Mingus	Fall	Score	
		3	-	1

1	Ramirez, Austin			
Sr	Douglas	Fall	Score	

		11	-	8

		Overall Record	36	-	2
--	--	----------------	----	---	---

11	Angel Rodriguez	31	-	10
Sr	Tempe	Fall	Score	
		12	-	10

7	Roberto Villalpando	32	-	7
Sr	Queen Creek	Fall	Score	
		7	-	6

7	Roberto Villalpando	31	-	7
Sr	Queen Creek	Fall	Score	
		5	-	4

**2006 AIA 4A Division I State Wrestling**

**Weight Class**

**171lb**

1	Adam Fager	38	-	3
So	Queen Creek			
<b>81</b>				
16	BYE			

1	Adam Fager	38	-	3
So	Queen Creek	<b>Fall</b>	<b>Score</b>	
		Bye	-	

9	Drake Luellen	2	-	3
Jr	Cactus Shad.			
<b>82</b>				
8	Isiah Whitehair	16	-	18
Jr	Page			

8	Isiah Whitehair	17	-	18
Jr	Page	<b>Fall</b>	<b>Score</b>	
		1:03	-	

5	CLINT GLADDEN	18	-	5
S0	BUCKEYE			
<b>83</b>				
12	Travis Walker	23	-	11
Sr	Coconino			

12	Travis Walker	24	-	11
Sr	Coconino	<b>Fall</b>	<b>Score</b>	
		3:14	-	

13	Mike Liberatore	10	-	12
Sr	Notre Dame			
<b>84</b>				
4	Gee, Kyle	11	-	3
Jr	Cholla			

4	Gee, Kyle	12	-	3
Jr	Cholla	<b>Fall</b>	<b>Score</b>	
		1:25	-	

3	Matt Schillington	22	-	3
Jr	Sunnyslope			
<b>85</b>				
14	LEROY FORFEIT	16	-	6
CORTEZ				

3	Matt Schillington	23	-	3
Jr	Sunnyslope	<b>Fall</b>	<b>Score</b>	
		Forfeit	-	

11	Miller, Ben	4	-	4
Jr	Rio Rico			
<b>86</b>				
6	Kyle Hunsaker	15	-	8
Sr	Higley			

11	Miller, Ben	5	-	4
Jr	Rio Rico	<b>Fall</b>	<b>Score</b>	
		0:52	-	

7	Lomeli, Ramon	16	-	9
Jr	Douglas			
<b>87</b>				
10	JEFF DEAN	6	-	4
DESERT EDGE				

10	JEFF DEAN	7	-	4
		<b>Fall</b>	<b>Score</b>	
		2:13	-	

15	Nate Carroll	8	-	22
Jr	Apache Jct.			
<b>88</b>				
2	Reece Roder	11	-	1
Sr	Mingus			

2	Reece Roder	12	-	1
Sr	Mingus	<b>Fall</b>	<b>Score</b>	
		1:24	-	

1	Adam Fager	39	-	3
So	Queen Creek	<b>Fall</b>	<b>Score</b>	
		1:18	-	

1	Adam Fager	40	-	3
So	Queen Creek	<b>Fall</b>	<b>Score</b>	
		4:47	-	

12	Travis Walker	25	-	11
Sr	Coconino	<b>Fall</b>	<b>Score</b>	
		12	-	8

2	Reece Roder	14	-	1
Sr	Mingus	<b>Fall</b>	<b>Score</b>	
		9	-	2

3	Matt Schillington	24	-	3
Jr	Sunnyslope	<b>Fall</b>	<b>Score</b>	
		16	-	1

2	Reece Roder	13	-	1
Sr	Mingus	<b>Fall</b>	<b>Score</b>	
		1:03	-	

2	Reece Roder	13	-	1
Sr	Mingus	<b>Fall</b>	<b>Score</b>	
		1:03	-	

1	Adam Fager	40	-	3
So	Queen Creek	<b>Fall</b>	<b>Score</b>	
		4:47	-	

2	Reece Roder	14	-	1
Sr	Mingus	<b>Fall</b>	<b>Score</b>	
		9	-	2

2	Reece Roder	14	-	1
Sr	Mingus	<b>Fall</b>	<b>Score</b>	
		9	-	2

2	Reece Roder	13	-	1
Sr	Mingus	<b>Fall</b>	<b>Score</b>	
		1:03	-	

2	Reece Roder			
Sr	Mingus	<b>Fall</b>	<b>Score</b>	
		11	-	4
Overall Record				
		15	-	1

321

403

322

193

194

195

196

**2006 AIA 4A Division I State Wrestling**

**Weight Class**

**189lb**

1	Frank Delagarza	21	-	1
Jr	Sunnyslope			
	<b>89</b>			

1	Frank Delagarza	21	-	1
Jr	Sunnyslope	<b>Fall</b>	<b>Score</b>	
	Bye			

9	Nick Serrano	19	-	9
Jr	Higley			
	<b>90</b>			

9	Nick Serrano	20	-	9
Jr	Higley	<b>Fall</b>	<b>Score</b>	
		1:08		

8	Figueroa, Hector	1	-	14
Sr	Rio Rico			

5	TYLER MILLER	17	-	5
SO	BUCKEYE			
	<b>91</b>			

5	TYLER MILLER	18	-	5
SO	BUCKEYE	<b>Fall</b>	<b>Score</b>	
		1:28		

12	Acosta, Paco	6	-	10
Sr	Douglas			

13	Jake Byers	20	-	4
Sr	Coronado			
	<b>92</b>			

4	Toby Hatcher	30	-	7
Sr	Coconino			

3	David Hollis	37	-	4
Jr	Queen Creek			
	<b>93</b>			

14	BRAD RACH	13	-	7
	DESERT EDGE			

11	Josh Benally	3	-	8
Fr	Page			
	<b>94</b>			

6	Fabian Esparza	16	-	13
	Washington			

7	Dalton Newell	17	-	10
Sr	Mingus			
	<b>95</b>			

10	FREDDY NAVARRETTE	8	-	5
	GLENDALE			

15	Tommy McLaughlin	6	-	13
So	Cactus Shad.			
	<b>96</b>			

2	House, Cody	35	-	2
Sr	Cholla			

**201**

**325**

**202**

**203**

**204**

1	Frank Delagarza	22	-	1
Jr	Sunnyslope	<b>Fall</b>	<b>Score</b>	
		3:22		

4	Toby Hatcher	33	-	7
Sr	Coconino	<b>Fall</b>	<b>Score</b>	
		9		7

4	Toby Hatcher	32	-	7
Sr	Coconino	<b>Fall</b>	<b>Score</b>	
		4:43		

4	Toby Hatcher	31	-	7
Sr	Coconino	<b>Fall</b>	<b>Score</b>	
		19		1

3	David Hollis	39	-	4
Jr	Queen Creek	<b>Fall</b>	<b>Score</b>	
		11		2

3	David Hollis	40	-	4
Jr	Queen Creek	<b>Fall</b>	<b>Score</b>	
		9		3

2	House, Cody	37	-	2
Sr	Cholla	<b>Fall</b>	<b>Score</b>	
		0:44		

**404**

3	David Hollis			
Jr	Queen Creek	<b>Fall</b>	<b>Score</b>	
		3		1
			Overtime	
	Overall Record	41		4

**2006 AIA 4A Division I State Wrestling**

**Weight Class**

**215lb**

1 Gonzales, Luciano 36 - 4

Sr Douglas  
97

16 BYE

9 Cory Ferguson 8 - 12

Jr Mingus  
98

8 TYLER GILMORE 14 - 9  
GLENDALE

5 Chris Sclafani 12 - 6

Jr Cactus Shad.  
99

12 JULIO GUZMAN 31 - 10

Mohave

13 Eric Mabes 22 - 10

Sr Coconino  
100

4 Robert Montano 17 - 5

Sr Higley

3 Nathan Tracy 17 - 3

Sr Page  
101

14 Brandon Sebahe 5 - 6

Jr Sunnyslope

11 Tim Harlan 16 - 17

So Apache Jct.  
102

6 House, Travis 34 - 3

Sr Cholla

7 Aulama Lemalu 15 - 21

So Queen Creek  
103

10 James Poag 18 - 10

Washington

15 Ahmad, Teleb 8 - 11

Jr Palo Verde  
104

2 BEN GARBETT 34 - 5

SR CORTEZ

1 Gonzales, Luciano 36 - 4

Sr Douglas **Fall** **Score**  
Bye -

209

9 Cory Ferguson 9 - 12

Jr Mingus **Fall** **Score**  
Default -

329

5 Chris Sclafani 13 - 6

Jr Cactus Shad. **Fall** **Score**  
5:30 -

210

4 Robert Montano 18 - 5

Sr Higley **Fall** **Score**  
11 - 8

1 Gonzales, Luciano 37 - 4

Sr Douglas **Fall** **Score**  
1:38 -

4 Robert Montano 19 - 5

Sr Higley **Fall** **Score**  
11 - 5

405

6 House, Travis 36 - 3

Sr Cholla **Fall** **Score**  
5:18 -

330

10 James Poag 20 - 10

Washington **Fall** **Score**  
10 - 5

1 Gonzales, Luciano 38 - 4

Sr Douglas **Fall** **Score**  
2:53 -

6 House, Travis 37 - 3

Sr Cholla **Fall** **Score**  
18 - 3

1 Gonzales, Luciano

Sr Douglas **Fall** **Score**  
4 -

Overall Record 39

Double Overtime -



**2006 AIA 4A Division I State Wrestling**

**Weight Class**

**HWT**

1	Daniel Gurrola	22	-	2
Washington				
<b>105</b>				

1	Daniel Gurrola	22	-	2
Washington				
<b>Fall</b>				
Bye				
<b>Score</b>				
-				

9	Bouscher, Taylor	5	-	15
Fr Palo Verde				
<b>106</b>				

8	MILTON WOOD	15	-	8
DESERT EDGE				
<b>Fall</b>				
0:29				
<b>Score</b>				
-				

5	Chris Settanni	7	-	9
So Mingus				
<b>107</b>				

12	KELLAND BROOKEVR	32	-	9
SO BUCKEYE				
<b>Fall</b>				
1:53				
<b>Score</b>				
-				

13	Fair, Mike	17	-	9
Sr Cholla				
<b>108</b>				

4	Zach Tourangeau	20	-	7
Jr Apache Jct.				
<b>Fall</b>				
4				
<b>Score</b>				
-				

3	Butierrez, Eddie	25	-	8
Sr Desert View				
<b>109</b>				

3	Butierrez, Eddie	26	-	8
Sr Desert View				
<b>Fall</b>				
1:15				
<b>Score</b>				
-				

11	Ian Spencer	19	-	17
So Queen Creek				
<b>110</b>				

11	Ian Spencer	20	-	17
So Queen Creek				
<b>Fall</b>				
0:39				
<b>Score</b>				
-				

6	Chris Daniels	5	-	5
So Sunnyslope				

7	Cody Taulton	15	-	3
Sr Higley				
<b>111</b>				

7	Cody Taulton	16	-	3
Sr Higley				
<b>Fall</b>				
0:15				
<b>Score</b>				
-				

10	Andrew Crook	9	-	14
Jr Coconino				

15	Cody Pinkerton	8	-	4
Jr Cactus Shad.				
<b>112</b>				

2	MATT GUYER	41	-	5
SR MOHAVE				
<b>Fall</b>				
0:35				
<b>Score</b>				
-				

2	MATT GUYER	40	-	5
SR MOHAVE				

1	Daniel Gurrola	23	-	2
Washington				
<b>Fall</b>				
0:35				
<b>Score</b>				
-				

1	Daniel Gurrola	24	-	2
Washington				
<b>Fall</b>				
8				
<b>Score</b>				
-				

4	Zach Tourangeau	21	-	7
Jr Apache Jct.				
<b>Fall</b>				
5:36				
<b>Score</b>				
-				

2	MATT GUYER	43	-	5
SR MOHAVE				
<b>Fall</b>				
1:31				
<b>Score</b>				
-				

3	Butierrez, Eddie	27	-	8
Sr Desert View				
<b>Fall</b>				
0:54				
<b>Score</b>				
-				

2	MATT GUYER	42	-	5
SR MOHAVE				
<b>Fall</b>				
1:02				
<b>Score</b>				
-				

2	MATT GUYER	43	-	5
SR MOHAVE				
<b>Fall</b>				
1:31				
<b>Score</b>				
-				

1	Daniel Gurrola	24	-	2
Washington				
<b>Fall</b>				
8				
<b>Score</b>				
-				

4	Zach Tourangeau	21	-	7
Jr Apache Jct.				
<b>Fall</b>				
5:36				
<b>Score</b>				
-				

2	MATT GUYER	43	-	5
SR MOHAVE				
<b>Fall</b>				
1:31				
<b>Score</b>				
-				

3	Butierrez, Eddie	27	-	8
Sr Desert View				
<b>Fall</b>				
0:54				
<b>Score</b>				
-				

2	MATT GUYER	42	-	5
SR MOHAVE				
<b>Fall</b>				
1:02				
<b>Score</b>				
-				

2	MATT GUYER	43	-	5
SR MOHAVE				
<b>Fall</b>				
1:31				
<b>Score</b>				
-				

2	Matt Guyer			
SR	Mohave	<b>Fall</b>	<b>Score</b>	
		0:54	-	
	Overall Record	44	-	5

2006 AIA 4A Division I State Wrestling

Weight Class

103lb

Consolation

16	BYE				
117					

9	BYE	#VALUE!	-	#VALUE!
		Fall	Score	
		Bye	-	
225				

9	BYE	-	#VALUE!
Loser of Bout	116		

10	Shawna Isabell	16	-	11
Fr	Coconino	Fall	Score	
		Bye	-	

12	Gomez, Victor	15	-	18
Fr	Douglas			
118				

13	Fabian Parra	24	-	10
Jr	Sunnyslope	Fall	Score	
			7	-
				1
226				

13	Fabian Parra	23	-	10
Jr	Sunnyslope			
Loser of Bout	115			

13	Fabian Parra	25	-	10
Jr	Sunnyslope	Fall	Score	
			5	-
				4

14	Chanty Fowler	19	-	16
Fr	Page			
119				

11	Nate Galvan	29	-	11
So	Apache Jct.	Fall	Score	
			6	-
				4
227				

11	Nate Galvan	28	-	11
So	Apache Jct.			
Loser of Bout	114			

4	Jacob Villa	26	-	12
So	Tempe	Fall	Score	
			2	-
				0

7	Ben Peterson	13	-	17
Fr	Coronado			
120				

7	Ben Peterson	14	-	17
Fr	Coronado	Fall	Score	
			9	-
				4
228				

15	JOHNNY SALDANA	6	-	12
0	DESERT EDGE			
Loser of Bout	113			

7	Ben Peterson	15	-	17
Fr	Coronado	Fall	Score	
			6	-
				3

8	Crockwell, Josh	5	-	3
Fr	Desert View			

283				
-----	--	--	--	--

13	Fabian Parra	26	-	10
Jr	Sunnyslope	Fall	Score	
			10	-
				6

337				
-----	--	--	--	--

13	Fabian Parra	27	-	10
Jr	Sunnyslope	Fall	Score	
			8	-
				5

1	SHANE DALY	37	-	7
FR	MOHAVE			
Loser of Bout	281			

2	Esteban, Celis	12	-	4
So	Rio Rico			
2:33				

2	Esteban, Celis	13	-	4
So	Rio Rico	Fall	Score	
			5	-
				2

4	Jacob Villa	27	-	12
So	Tempe	Fall	Score	
			10	-
				0

2	Esteban, Celis	13	-	4
So	Rio Rico	Fall	Score	
			5	-
				2

4	Jacob Villa	27	-	12
So	Tempe	Fall	Score	
			10	-
				0

1	SHANE DALY	37	-	8
FR	MOHAVE			
Loser of Bout	366			

*Thomas P. P. P.*

*Thomas P. P. P.*

4	Jacob Villa	28	-	13
So	Tempe	Fall	Score	
			12	-
				3

2006 AIA 4A Division I State Wrestling

Weight Class

112lb

Consolation

16	BYE				
	125				
8	TROY NAHRGANG	24	-	14	
FR	BUCKEYE				

8	TROY NAHRGANG	25	-	14	
FR	BUCKEYE	Fall	Score		
		Bye	-		
	229				

	Loser of Bout	124			
5	Adam Ulibarri	18	-	18	
Jr	Coconino				
	126				

5	Adam Ulibarri	19	-	18	
Jr	Coconino	Fall	Score		
		6	-	4	
	230				

13	McDaniel, Bryce	21	-	11	
Sr	Cholla				
	Loser of Bout	123			

6	Travis Huff	29	-	5	
So	Coronado				

14	Nick Sepulveda	12	-	9	
Jr	Flagstaff				
	127				

14	Nick Sepulveda	13	-	9	
Jr	Flagstaff	Fall	Score		
		13	-	5	
	231				

11	Riley O'Neal	10	-	13	
Jr	Cactus Shad.				
	Loser of Bout	122			

12	JEREMY VALLEJO	27	-	13	
	DYSART				

10	Phil Williams	20	-	19	
Fr	Mingus				
	128				

15	Kyle McMinn	26	-	16	
So	Apache Jct.	Fall	Score		
		16	-	0	
	232				

15	Kyle McMinn	25	-	16	
So	Apache Jct.				
	Loser of Bout	121			

9	Andrade, Ali	16	-	11	
Fr	Douglas				

7	Raymond Camacho	20	-	13	
	Washington	Fall	Score		
		5	-	1	

6	Travis Huff	31	-	5	
So	Coronado	Fall	Score		
		17	-	1	

6	Travis Huff	30	-	5	
So	Coronado	Fall	Score		
		12	-	8	

4	Francisco Mora	18	-	8	
Sr	Sunnyslope				

12	JEREMY VALLEJO	28	-	13	
	DYSART	Fall	Score		
		4:13	-		

12	JEREMY VALLEJO	29	-	13	
	DYSART	Fall	Score		
		1	-	0	

7	Raymond Camacho	20	-	13	
	Washington	Fall	Score		
		5	-	1	

6	Travis Huff	31	-	5	
So	Coronado	Fall	Score		
		17	-	1	

6	Travis Huff	30	-	5	
So	Coronado	Fall	Score		
		12	-	8	

4	Francisco Mora	18	-	8	
Sr	Sunnyslope				

12	JEREMY VALLEJO	28	-	13	
	DYSART	Fall	Score		
		4:13	-		

12	JEREMY VALLEJO	29	-	13	
	DYSART	Fall	Score		
		1	-	0	

7	Raymond Camacho	20	-	13	
	Washington	Fall	Score		
		5	-	1	

6	Travis Huff	31	-	5	
So	Coronado	Fall	Score		
		17	-	1	

4	Francisco Mora	19	-	8	
Sr	Sunnyslope	Fall	Score		
		3	-	0	

4	Francisco Mora	18	-	8	
Sr	Sunnyslope				

12	JEREMY VALLEJO	28	-	13	
	DYSART	Fall	Score		
		4:13	-		

12	JEREMY VALLEJO	29	-	13	
	DYSART	Fall	Score		
		1	-	0	

*Travis Huff*

3	Garcia, Matt	40	-	4	
Sr	Desert View	Fall	Score		
		18	-	0	

*Travis Huff*

12	JEREMY VALLEJO	30	-	14	
	DYSART	Fall	Score		
		3	-	1	

2006 AIA 4A Division I State Wrestling

Weight Class 119lb

Consolation

16	BYE				
	133				

9	Roman Isabell	12	-	17
So	Coconino	Fall	Score	
		Bye	-	
	233			

9	Roman Isabell	11	-	17
So	Coconino			

Loser of Bout 132

2	JARED HIGGINS	41	-	6
JR	MOHAVE			

12	TERRENCE HUSKON	4	-	7
FR	DESERT EDGE			

4	Mesa, Valentin	9	-	5
So	Desert View	Fall	Score	
		20	-	18
	234			

4	Mesa, Valentin	8	-	5
So	Desert View			

Loser of Bout 131

11	Sean, Bryan	28	-	7
Jr	Santa Rita			

14	Boris Suleymanov	5	-	8
	Washington			

6	Long Le	11	-	11
Sr	Higley	Fall	Score	
		1:40	-	
	235			

6	Long Le	10	-	11
Sr	Higley			

Loser of Bout 130

5	Zach O'Kane	18	-	11
Jr	Cactus Shad.			

10	Sam Houston	12	-	11
So	Sunnyslope			

15	Tony Rodriguez	20	-	13
So	Tempe	Fall	Score	
		3	-	1
	236			

15	Tony Rodriguez	19	-	13
So	Tempe			

Loser of Bout 129

8	TROY GANLEY	34	-	8
SO	BUCKEYE			

2	JARED HIGGINS	42	-	6
JR	MOHAVE	Fall	Score	
		12	-	6

2	JARED HIGGINS	43	-	6
JR	MOHAVE	Fall	Score	
		5	-	3

11	Sean, Bryan	29	-	7
Jr	Santa Rita	Fall	Score	
		5	-	4

Loser of Bout 289

13	Wes Lymangrover	27	-	15
Fr	Mingus			

Loser of Bout 290

7	Clapeck, JJ	20	-	4
Jr	Rio Rico			

5	Zach O'Kane	19	-	11
Jr	Cactus Shad.	Fall	Score	
		12	-	5

8	TROY GANLEY	36	-	8
SO	BUCKEYE	Fall	Score	
		7	-	1

8	TROY GANLEY	35	-	8
SO	BUCKEYE	Fall	Score	
		5	-	2

13	Wes Lymangrover	28	-	15
Fr	Mingus	Fall	Score	
		11	-	6

7	Clapeck, JJ	22	-	4
Jr	Rio Rico	Fall	Score	
		5	-	3

7	Clapeck, JJ	21	-	4
Jr	Rio Rico	Fall	Score	
		8	-	0

2	JARED HIGGINS	43	-	7
JR	MOHAVE			
	370			

8	TROY GANLEY	36	-	9
SO	BUCKEYE			

*Third Place*

7	Clapeck, JJ	22	-	4
Jr	Rio Rico	Fall	Score	
		5	-	3

*First Place*

2	JARED HIGGINS	44	-	7
JR	MOHAVE	Fall	Score	
		9	-	1

2006 AIA 4A Division I State Wrestling

Weight Class 125lb

Consolation

16	BYE				
	141				
8	Harrie Baker	20	-	15	
Sr	Flagstaff				

8	Harrie Baker	21	-	15	
Sr	Flagstaff	Fall	Score		
		Bye	-		
	237				
7	Enrico Fabiani	18	-	5	
Jr	Notre Dame				

5	Sandoval, Victor	2	-	1	
So	Desert View				
	142				
4	Thomas Colyar	17	-	12	
	Washington				

4	Thomas Colyar	18	-	12	
	Washington	Fall	Score		
		2:31	-		
	238				
3	Alex Freed	16	-	8	
Jr	Apache Jct.				

14	Beeston, Steven	8	-	14	
Fr	Santa Rita				
	143				
11	Mylo Parra	9	-	10	
Sr	Sunnyslope				

11	Mylo Parra	10	-	10	
Sr	Sunnyslope	Fall	Score		
		3:38	-		
	239				
13	Christian Espinoza	12	-	8	
Jr	Tempe				

10	Fraijo, Rocky	7	-	8	
Jr	Douglas				
	144				
15	MIKE RUHE	7	-	14	
	CORTEZ				

15	MIKE RUHE	8	-	14	
	CORTEZ	Fall	Score		
		7	-	6	
	240				
9	Taylor McArthur	14	-	15	
So	Higley				

7	Enrico Fabiani	19	-	5	
Jr	Notre Dame	Fall	Score		
		12	-	10	
	295				
3	Alex Freed	17	-	8	
Jr	Apache Jct.	Fall	Score		
		8	-	3	

3	Alex Freed	17	-	8	
Jr	Apache Jct.	Fall	Score		
		8	-	3	
	293				
12	Brian Lymangrover	12	-	10	
Jr	Mingus				

13	Christian Espinoza	13	-	8	
Jr	Tempe	Fall	Score		
		8	-	5	
	296				
13	Christian Espinoza	14	-	8	
Jr	Tempe	Fall	Score		
		15	-	12	

9	Taylor McArthur	15	-	15	
So	Higley	Fall	Score		
		1:42	-		
	294				
6	JEREMY SCHWIESOW	19	-	4	
SO	BUCKEYE				

7	Enrico Fabiani	20	-	5	
Jr	Notre Dame	Fall	Score		
		9	-	0	
	343				
12	Brian Lymangrover	13	-	10	
Jr	Mingus	Fall	Score		
		3:20	-		

12	Brian Lymangrover	12	-	10	
Jr	Mingus				
	371				
6	JEREMY SCHWIESOW	19	-	4	
SO	BUCKEYE				

6	JEREMY SCHWIESOW	20	-	4	
SO	BUCKEYE	Fall	Score		
		12	-	5	

7	Enrico Fabiani	20	-	6	
Jr	Notre Dame				
	372				
13	Christian Espinoza	14	-	9	
Jr	Tempe				

12	Brian Lymangrover	14	-	10	
Jr	Mingus	Fall	Score		
		1:56	-		

13	Christian Espinoza	15	-	9	
Jr	Tempe	Fall	Score		
		14	-	9	

*Thomas Colyar*

*Mylo Parra*

2006 AIA 4A Division I State Wrestling

Weight Class 130lb

Consolation

16	BYE				
	149				
9	Ryan Yates	17	-	19	
Jr	Apache Jct.	Fall	Score		
		Bye	-		

9	Ryan Yates	17	-	19	
Jr	Apache Jct.	Fall	Score		
		Bye	-		
	241				

9	Ryan Yates	16	-	19	
Jr	Apache Jct.				
	Loser of Bout	148			

7	DANIEL CORONADO	15	-	12	
	DYSART				

7	DANIEL CORONADO	16	-	12	
	DYSART	Fall	Score		
		2:58	-		

5	Jonathan Camacho	13	-	5	
	Washington				
	150				

13	Cris Ries	14	-	14	
So	Higley	Fall	Score		
		1:08	-		
	242				

13	Cris Ries	13	-	14	
So	Higley				
	Loser of Bout	147			

11	AMMON BYBEE	20	-	14	
So	BUCKEYE				

11	AMMON BYBEE	21	-	14	
So	BUCKEYE	Fall	Score		
		9	-	7	

14	Keith Howell	5	-	12	
Jr	Cactus Shad.				
	151				

6	Joel Giannola	18	-	12	
Fr	Flagstaff	Fall	Score		
		8	-	4	
	243				

6	Joel Giannola	17	-	12	
Fr	Flagstaff				
	Loser of Bout	146			

12	Manuel Jose	8	-	6	
So	Desert View				

6	Joel Giannola	19	-	12	
Fr	Flagstaff	Fall	Score		
		10	-	6	

10	Alec Schmelling	11	-	20	
Jr	Sunnyslope				
	152				

15	Matt Dyer	13	-	12	
Jr	Coconino	Fall	Score		
		4:07	-		
	244				

15	Matt Dyer	12	-	12	
Jr	Coconino				
	Loser of Bout	145			

8	Ramirez, Cody	22	-	14	
So	Douglas				

15	Matt Dyer	14	-	12	
Jr	Coconino	Fall	Score		
		2:58	-		

15	Matt Dyer	14	-	12	
Jr	Coconino	Fall	Score		
		2:58	-		

7	DANIEL CORONADO	17	-	12	
	DYSART	Fall	Score		
		2:36	-		

11	AMMON BYBEE	21	-	14	
So	BUCKEYE	Fall	Score		
		9	-	7	

4	CHRIS PUGH	39	-	8	
SR	MOHAVE				

4	CHRIS PUGH	39	-	8	
SR	MOHAVE				

3	Ceenan Jackson	29	-	6	
Sr	Coronado				

6	Joel Giannola	19	-	12	
Fr	Flagstaff	Fall	Score		
		10	-	6	

15	Matt Dyer	15	-	12	
Jr	Coconino	Fall	Score		
		5	-	1	

15	Matt Dyer	15	-	12	
Jr	Coconino	Fall	Score		
		5	-	1	

4	CHRIS PUGH	40	-	8	
SR	MOHAVE	Fall	Score		
		8	-	7	

4	CHRIS PUGH	39	-	8	
SR	MOHAVE				

3	Ceenan Jackson	31	-	6	
Sr	Coronado	Fall	Score		
		1	-	0	

3	Ceenan Jackson	29	-	6	
Sr	Coronado				

3	Ceenan Jackson	30	-	6	
Sr	Coronado	Fall	Score		
		12	-	5	

15	Matt Dyer	15	-	12	
Jr	Coconino	Fall	Score		
		5	-	1	

15	Matt Dyer	15	-	12	
Jr	Coconino	Fall	Score		
		5	-	1	

7	DANIEL CORONADO	17	-	13	
	DYSART				
	374				

15	Matt Dyer	16	-	13	
Jr	Coconino	Fall	Score		
		7	-	3	

*Third Place*

*Third Place*

2006 AIA 4A Division I State Wrestling

Weight Class 135lb

Consolation

16	BYE				
	157				
9	ANDREW PARRA	30	-	14	
FR	MOHAVE				

9	ANDREW PARRA	31	-	14	
FR	MOHAVE	Fall	Score		
		Bye	-		
	245				

	Loser of Bout	156			
--	---------------	-----	--	--	--

2	Barroso, John Paul	23	-	4	
Sr	Douglas				

12	Rascon, Orlando	22	-	10	
So	Santa Rita				
	158				
13	BRYAN PETERSON	26	-	9	
SR	BUCKEYE				

13	BRYAN PETERSON	27	-	9	
SR	BUCKEYE	Fall	Score		
		2:38	-		
	246				

	Loser of Bout	155			
--	---------------	-----	--	--	--

3	ISSAC SELIN	30	-	6	
SR	CORTEZ				

14	Jeremy Vick	9	-	17	
So	Bradshaw Mtn.				
	159				
11	Danny Parado	22	-	10	
So	Coronado				

11	Danny Parado	23	-	10	
So	Coronado	Fall	Score		
		1:09	-		
	247				

	Loser of Bout	154			
--	---------------	-----	--	--	--

5	Roby Owsley	16	-	6	
Jr	Sunnyslope				

10	Brian Colan	9	-	7	
So	Cactus Shad.				
	160				
15	Mike Roberts	7	-	7	
Sr	Flagstaff				

15	Mike Roberts	8	-	7	
Sr	Flagstaff	Fall	Score		
		12	-	4	
	248				

	Loser of Bout	153			
--	---------------	-----	--	--	--

8	Velasco, Luis	5	-	17	
Fr	Rio Rico				

2	Barroso, John Paul	24	-	4	
Sr	Douglas	Fall	Score		
		2:07	-		

3	ISSAC SELIN	31	-	6	
SR	CORTEZ	Fall	Score		
		3:40	-		

3	ISSAC SELIN	32	-	6	
SR	CORTEZ	Fall	Score		
		7	-	2	

	Loser of Bout	301			
--	---------------	-----	--	--	--

4	Tod Workman	34	-	11	
So	Queen Creek				

	Loser of Bout	302			
--	---------------	-----	--	--	--

7	Traston Yates	18	-	10	
Sr	Apache Jct.				

5	Roby Owsley	17	-	6	
Jr	Sunnyslope	Fall	Score		
		13	-	4	

5	Roby Owsley	18	-	6	
Jr	Sunnyslope	Fall	Score		
		9	-	0	

15	Mike Roberts	9	-	7	
Sr	Flagstaff	Fall	Score		
		4:27	-		

3	ISSAC SELIN	32	-	6	
SR	CORTEZ	Fall	Score		
		7	-	2	

3	ISSAC SELIN	31	-	6	
SR	CORTEZ	Fall	Score		
		3:40	-		

4	Tod Workman	35	-	11	
So	Queen Creek	Fall	Score		
		5	-	4	

4	Tod Workman	34	-	11	
So	Queen Creek				

7	Traston Yates	18	-	10	
Sr	Apache Jct.				

5	Roby Owsley	19	-	6	
Jr	Sunnyslope	Fall	Score		
		12	-	3	

5	Roby Owsley	18	-	6	
Jr	Sunnyslope	Fall	Score		
		9	-	0	

3	ISSAC SELIN	32	-	6	
SR	CORTEZ	Fall	Score		
		7	-	2	

4	Tod Workman	35	-	11	
So	Queen Creek	Fall	Score		
		5	-	4	

4	Tod Workman	34	-	11	
So	Queen Creek				

7	Traston Yates	18	-	10	
Sr	Apache Jct.				

5	Roby Owsley	19	-	6	
Jr	Sunnyslope	Fall	Score		
		12	-	3	

5	Roby Owsley	18	-	6	
Jr	Sunnyslope	Fall	Score		
		9	-	0	

3	ISSAC SELIN	32	-	7	
SR	CORTEZ	Fall	Score		
		376	-		

7	Traston Yates	18	-	11	
Sr	Apache Jct.				

4	Tod Workman	36	-	11	
So	Queen Creek	Fall	Score		
		4	-	2	

3	ISSAC SELIN	33	-	7	
SR	CORTEZ	Fall	Score		
		16	-	1	

*Traston Yates*

*Traston Yates*

2006 AIA 4A Division I State Wrestling

Weight Class 140lb

Consolation

16	BYE	165
----	-----	-----

8	Miller, Mark	7	-	8
So	Rio Rico	Fall	Score	-
		Bye		

8	Miller, Mark	6	-	8
So	Rio Rico			

Loser of Bout 164

7	Danny Montoya	7	-	14
So	Bradshaw Mtn.			

7	Danny Montoya	8	-	14
So	Bradshaw Mtn.	Fall	Score	-
		1:21		

12	Navarrete, Adrain Jr	15	-	12
	Douglas			

13	Sam Harlan	30	-	9
Sr	Apache Jct.	Fall	Score	-
		1:52		

13	Sam Harlan	29	-	9
Sr	Apache Jct.			

Loser of Bout 163

6	Rudy Kovac	15	-	11
Sr	Flagstaff			

13	Sam Harlan	31	-	9
Sr	Apache Jct.	Fall	Score	-
		19		3

Loser of Bout 305

5	CURTIS WRIGHT JR	27	-	12
	BUCKEYE			

14	JOESEPH BRADSHAW DYSART	20	-	14

14	JOESEPH BRADSHAW DYSART	21	-	14
		Fall	Score	-
		2:42		

11	Bryce Altaffer	1	-	2
Fr	Sunnyslope			

Loser of Bout 162

4	Peter Daniczek	19	-	4
Sr	Notre Dame			

13	Sam Harlan	31	-	9
Sr	Apache Jct.	Fall	Score	-
		19		3

Loser of Bout 306

2	Vallejo, Daniel	34	-	5
Fr	Cholla			

10	RANDY QUEEN FR MOHAVE	19	-	9

10	RANDY QUEEN FR MOHAVE	20	-	9
		Fall	Score	-
		7		2

15	Anthony Lucero	14	-	14
So	Page			

Loser of Bout 161

9	Nathan Selman	16	-	11
Fr	Tempe			

4	Peter Daniczek	20	-	4
Sr	Notre Dame	Fall	Score	-
		8		0

Loser of Bout 308

4	Peter Daniczek	21	-	4
Sr	Notre Dame	Fall	Score	-
		12		2

4	Peter Daniczek	20	-	4
Sr	Notre Dame	Fall	Score	-
		8		0

2	Vallejo, Daniel	35	-	5
Fr	Cholla	Fall	Score	-
		4		1

5	CURTIS WRIGHT JR	27	-	13
	BUCKEYE			

378

4	Peter Daniczek	21	-	5
Sr	Notre Dame			

13	Sam Harlan	34	-	9
Sr	Apache Jct.	Fall	Score	-
		2:00		

*Thomas Place*

*Thomas Place*

5	CURTIS WRIGHT JR	28	-	13
	BUCKEYE	Fall	Score	-
		5		4



2006 AIA 4A Division I State Wrestling

Weight Class 145lb

Consolation

16	BYE				
	173				

9	Matt Delagarza	10	-	13
	Washington	Fall	Score	
		Bye	-	
	253			

9	Matt Delagarza	9	-	13
	Washington			
	Loser of Bout	172		

7	Brown, Jeff	21	-	7
	Sr Palo Verde	Fall	Score	
		0:59	-	

5	Adam Earles	18	-	6
	Jr Mingus			
	174			

5	Adam Earles	19	-	6
	Jr Mingus	Fall	Score	
		0:47	-	
	254			

13	Eric Herrin	12	-	15
	Sr Bradshaw Mtn.			
	Loser of Bout	171		

7	Brown, Jeff	20	-	7
	Sr Palo Verde			
	311			

5	Adam Earles	21	-	6
	Jr Mingus	Fall	Score	
		4:35	-	
	351			

14	Ben Conklin	14	-	7
	S0 Sinagua			
	175			

14	Ben Conklin	15	-	7
	S0 Sinagua	Fall	Score	
		2:18	-	
	255			

11	Goble, Andy	18	-	11
	So Santa Rita			
	Loser of Bout	170		

5	Adam Earles	20	-	6
	Jr Mingus	Fall	Score	
		5	-	4
	Loser of Bout	309		

1	Jake DeVree	25	-	4
	Sr Apache Jct.			
	Loser of Bout	310		

1	Jake DeVree	26	-	4
	Sr Apache Jct.	Fall	Score	
		6	-	2

10	Jared Marks	8	-	8
	Jr Cococino			
	176			

15	John Zuniga	14	-	11
	Jr Higley	Fall	Score	
		12	-	9
	256			

15	John Zuniga	13	-	11
	Jr Higley			
	Loser of Bout	169		

12	LOGAN YOUNG	23	-	5
	JR BUCKEYE	Fall	Score	
		1:50	-	
	312			

2	PAT LAHAIE	20	-	4
	DESERT EDGE			
	Loser of Bout	310		

1	Jake DeVree	27	-	4
	Sr Apache Jct.	Fall	Score	
		5	-	0

8	SETH LOWRY	27	-	14
	DYSART	Fall	Score	
		15	-	6

12	LOGAN YOUNG	24	-	5
	JR BUCKEYE	Fall	Score	
		7	-	5

12	LOGAN YOUNG	25	-	5
	JR BUCKEYE	Fall	Score	
		10	-	7

5	Adam Earles	21	-	7
	Jr Mingus			
	380			
	Loser of Bout	169		

*Thomas Place*

1	Jake DeVree	27	-	4
	Sr Apache Jct.	Fall	Score	
		5	-	0

*Thomas Place*

2	PAT LAHAIE	21	-	5
	DESERT EDGE	Fall	Score	
		7	-	5

2006 AIA 4A Division I State Wrestling

Weight Class

152lb

Consolation

16	BYE				
	181				
9	RYAN ESPARZA	14	-	17	
	DYSART				

9	RYAN ESPARZA	15	-	17	
	DYSART	Fall	Score		
		Bye	-		
	257				

Loser of Bout 180

10	Enriquez, Luis	20	-	17	
	Fr	Cholla			

12	Andrew Roper	18	-	7	
	Sr	Higley			
	182				

12	Andrew Roper	19	-	7	
	Sr	Higley	Fall	Score	
			1:27	-	
	258				

13	ABRAHAM PARRA	31	-	14	
	FR	MOHAVE			
	183				

12	Andrew Roper	20	-	7	
	Sr	Higley	Fall	Score	
			3:38	-	
	259				

Loser of Bout 179

6	Joe Mlachak	9	-	9	
	Jr	Notre Dame			

3	TRAVIS HARDON	11	-	5	
	SR	GLENDALE			
	183				

3	TRAVIS HARDON	12	-	5	
	SR	GLENDALE	Fall	Score	
			0:46	-	
	259				

11	Keith Ryan	12	-	17	
	Jr	Flagstaff			
	183				

5	Palacio, Daniel	7	-	2	
	Sr	Desert View	Fall	Score	
				-	3
	259				

Loser of Bout 178

5	Palacio, Daniel	6	-	2	
	Sr	Desert View			

7	Tyson Bigman	2	-	2	
	Jr	Page			
	184				

15	David Romero	6	-	2	
		Washington	Fall	Score	
			3:18	-	
	260				

15	David Romero	5	-	2	
		Washington			
	184				

8	Jake Goddard	24	-	14	
	Fr	Queen Creek	Fall	Score	
				-	6
	260				

Loser of Bout 177

8	Jake Goddard	23	-	14	
	Fr	Queen Creek			

9	RYAN ESPARZA	16	-	17	
	DYSART	Fall	Score		
			6	-	5
	315				

12	Andrew Roper	21	-	7	
	Sr	Higley	Fall	Score	
				-	3
	353				

12	Andrew Roper	20	-	7	
	Sr	Higley	Fall	Score	
				-	
	353				

4	Cody Rader	25	-	15	
	Jr	Mingus	Fall	Score	
				-	1
	381				

4	Cody Rader	24	-	15	
	Jr	Mingus			
	313				

14	Kingsford, David	15	-	10	
	Fr	Rio Rico			
	314				

5	Palacio, Daniel	8	-	2	
	Sr	Desert View	Fall	Score	
				-	3
	354				

5	Palacio, Daniel	9	-	2	
	Sr	Desert View	Fall	Score	
				-	2
	354				

5	Palacio, Daniel	8	-	2	
	Sr	Desert View	Fall	Score	
				-	0
	316				

12	Andrew Roper	21	-	8	
	Sr	Higley			
	382				

14	Kingsford, David	15	-	11	
	Fr	Rio Rico			

4	Cody Rader	25	-	15	
	Jr	Mingus	Fall	Score	
				-	1
	381				

4	Cody Rader	24	-	15	
	Jr	Mingus			
	313				

14	Kingsford, David	15	-	10	
	Fr	Rio Rico			
	314				

5	Palacio, Daniel	9	-	2	
	Sr	Desert View	Fall	Score	
				-	2
	354				

5	Palacio, Daniel	8	-	2	
	Sr	Desert View	Fall	Score	
				-	0
	316				

12	Andrew Roper	21	-	8	
	Sr	Higley			
	382				

14	Kingsford, David	15	-	11	
	Fr	Rio Rico			

*Desert View*

5	Palacio, Daniel	10	-	2	
	Sr	Desert View	Fall	Score	
				-	
			3:40	-	

*Desert View*

12	Andrew Roper	22	-	8	
	Sr	Higley	Fall	Score	
				-	
			3:59	-	

2006 AIA 4A Division I State Wrestling

Weight Class

160lb

Consolation

16	BYE				
189					

8	Earl Langendorf	4	-	6
	Washington	Fall	Score	
		Bye	-	

8	Earl Langendorf	3	-	6
	Washington			

Loser of Bout 188

2	Zhami Doko	27	-	7
	Jr Sunnyslope			

12	Chance Meeks	8	-	13
	So Notre Dame			

13	TONY MORNEAU	17	-	3
	SR DESERT EDGE	Fall	Score	
		2:25	-	

13	TONY MORNEAU	16	-	3
	SR DESERT EDGE			

Loser of Bout 187

3	TREY NAHRGANG	28	-	8
	SO BUCKEYE			

14	Soto FORFEIT	9	-	9
	So Flagstaff			

6	Hunt, Kevin	12	-	11
	Sr Palo Verde	Fall	Score	
		Forfeit	-	

6	Hunt, Kevin	11	-	11
	Sr Palo Verde			

Loser of Bout 186

4	Kyle Lebtich	20	-	6
	Sr Higley			

10	Mitchell Buchanan	11	-	14
	Sr Coconino			

10	Mitchell Buchanan	12	-	14
	Sr Coconino	Fall	Score	
		1:46	-	

15	Valdez, Mario	5	-	13
	Fr Rio Rico			

Loser of Bout 185

9	JACOB HALL	20	-	13
	CORTEZ			

2	Zhami Doko	28	-	7
	Jr Sunnyslope	Fall	Score	
		1:36	-	

3	TREY NAHRGANG	30	-	8
	SO BUCKEYE	Fall	Score	
		20	-	7

3	TREY NAHRGANG	29	-	8
	SO BUCKEYE	Fall	Score	
		1:40	-	

Loser of Bout 317

5	Rowdy Scott	11	-	10
	So Mingus			

Loser of Bout 318

11	Angel Rodriguez	31	-	11
	Sr Tempe			

4	Kyle Lebtich	21	-	6
	Sr Higley	Fall	Score	
		6	-	2

4	Kyle Lebtich	22	-	6
	Sr Higley	Fall	Score	
		10	-	9

9	JACOB HALL	21	-	13
	CORTEZ	Fall	Score	
		17	-	10

3	TREY NAHRGANG	31	-	8
	SO BUCKEYE	Fall	Score	
		0:59	-	

3	TREY NAHRGANG	31	-	8
	SO BUCKEYE	Fall	Score	
		0:59	-	

11	Angel Rodriguez	32	-	11
	Sr Tempe	Fall	Score	
		6	-	4

5	Rowdy Scott	11	-	11
	So Mingus			

4	Kyle Lebtich	23	-	7
	Sr Higley	Fall	Score	
		3	-	1

*Temp Place*

*Temp Place*

2006 AIA 4A Division I State Wrestling

Weight Class

171lb

Consolation

16	BYE				
	197				

9	Drake Luellen	3	-	4
Jr	Cactus Shad.	Fall	Score	
		Bye	-	

9	Drake Luellen	2	-	4
Jr	Cactus Shad.			

Loser of Bout 196

10	JEFF DEAN	7	-	5
	DESERT EDGE			

10	JEFF DEAN	8	-	5
	DESERT EDGE	Fall	Score	
		2	-	0

5	CLINT GLADDEN	18	-	6
S0	BUCKEYE			
	198			

5	CLINT GLADDEN	19	-	6
S0	BUCKEYE	Fall	Score	
		0:56	-	

13	Mike Liberatore	10	-	13
Sr	Notre Dame			

Loser of Bout 195

11	Miller, Ben	5	-	5
Jr	Rio Rico			

5	CLINT GLADDEN	20	-	6
S0	BUCKEYE	Fall	Score	
		0:40	-	

Loser of Bout 321

5	CLINT GLADDEN	21	-	6
S0	BUCKEYE	Fall	Score	
		0:49	-	

357

5	CLINT GLADDEN	22	-	6
S0	BUCKEYE	Fall	Score	
		8	-	7

Loser of Bout 322

12	Travis Walker	25	-	12
Sr	Coconino			

385

*Travis Walker*

3	Matt Schillington	26	-	4
Jr	Sunnyslope	Fall	Score	
		11	-	1

14	LEROY FORFEIT	16	-	7
	CORTEZ			
	199			

6	Kyle Hunsaker	16	-	9
Sr	Higley	Fall	Score	
		Forfeit	-	

6	Kyle Hunsaker	15	-	9
Sr	Higley			

Loser of Bout 194

4	Gee, Kyle	12	-	4
Jr	Cholla			

4	Gee, Kyle	13	-	4
Jr	Cholla	Fall	Score	
		6	-	4

358

3	Matt Schillington	25	-	4
Jr	Sunnyslope	Fall	Score	
		8	-	5

7	Lomeli, Ramon	16	-	10
Jr	Douglas			
	200			

7	Lomeli, Ramon	17	-	10
Jr	Douglas	Fall	Score	
		0:57	-	

15	Nate Carroll	8	-	23
Jr	Apache Jct.			

Loser of Bout 193

8	Isiah Whitehair	17	-	19
Jr	Page			

8	Isiah Whitehair	18	-	19
Jr	Page	Fall	Score	
		4:44	-	

4	Gee, Kyle	14	-	4
Jr	Cholla	Fall	Score	
		4:21	-	

12	Travis Walker	25	-	13
Sr	Coconino			
	386			

*Travis Walker*

12	Travis Walker	26	-	13
Sr	Coconino	Fall	Score	
		11	-	2

2006 AIA 4A Division I State Wrestling

Weight Class 189lb

Consolation

16	BYE				
205					

8	Figueroa, Hector	2	-	15
Sr	Rio Rico	Fall	Score	-
		Bye		

8	Figueroa, Hector	1	-	15
Sr	Rio Rico			

Loser of Bout 204

7	Dalton Newell	18	-	11
Sr	Mingus			

7	Dalton Newell	19	-	11
Sr	Mingus	Fall	Score	-
		0:48		

12	Acosta, Paco	6	-	11
Sr	Douglas			
206				

12	Acosta, Paco	7	-	11
Sr	Douglas	Fall	Score	-
		2:40		

13	Jake Byers	20	-	5
Sr	Coronado			

Loser of Bout 203

6	Fabian Esparza	17	-	14
	Washington			

6	Fabian Esparza	18	-	14
	Washington	Fall	Score	-
		4:44		

Loser of Bout 325

6	Fabian Esparza	19	-	14
	Washington	Fall	Score	-
		1:24		

Loser of Bout 359

1	Frank Delagarza	23	-	2
Jr	Sunnyslope	Fall	Score	-
		3:55		

Loser of Bout 326

1	Frank Delagarza	22	-	2
Jr	Sunnyslope			

*Transferee*

1	Frank Delagarza	24	-	2
Jr	Sunnyslope	Fall	Score	-
		Default		

14	BRAD RACH	13	-	8
	DESERT EDGE			
207				

14	BRAD RACH	14	-	8
	DESERT EDGE	Fall	Score	-
		0:54		

11	Josh Benally	3	-	9
Fr	Page			

Loser of Bout 202

5	TYLER MILLER	18	-	6
SO	BUCKEYE			

14	BRAD RACH	15	-	8
	DESERT EDGE	Fall	Score	-
		1:36		

Loser of Bout 360

2	House, Cody	38	-	3
Sr	Cholla	Fall	Score	-
		5		2

10	FREDDY NAVARRETTE	8	-	6
	GLENDALE			
208				

10	FREDDY NAVARRETTE	9	-	6
	GLENDALE	Fall	Score	-
		2:13		

15	Tommy McLaughlin	6	-	14
So	Cactus Shad.			

Loser of Bout 201

9	Nick Serrano	20	-	10
Jr	Higley			

9	Nick Serrano	21	-	10
Jr	Higley	Fall	Score	-
		0:58		

9	Nick Serrano	22	-	10
Jr	Higley	Fall	Score	-
		2:53		

6	Fabian Esparza	19	-	15
	Washington			

*Transferee*

9	Nick Serrano	23	-	11
Jr	Higley	Fall	Score	-
		14		4

2006 AIA 4A Division I State Wrestling

Weight Class

215lb

Consolation

16	BYE				
213					

8	TYLER GILMORE	15	-	10
	GLENDALE	Fall	Score	
		Bye	-	
273				

8	TYLER GILMORE	14	-	10
	GLENDALE			
Loser of Bout	212			

2	BEN GARBETT	35	-	6
	SR CORTEZ			

12	JULIO GUZMAN	31	-	11
	Mohave			
214				

13	Eric Mabes	23	-	11
	Sr Coconino	Fall	Score	
		4:12	-	
274				

13	Eric Mabes	22	-	11
	Sr Coconino			
Loser of Bout	211			

3	Nathan Tracy	18	-	4
	Sr Page			

14	Brandon Sebabe	5	-	7
	Jr Sumyslope			
215				

11	Tim Harlan	17	-	18
	So Apache Jct.	Fall	Score	
		10	-	6
275				

11	Tim Harlan	16	-	18
	So Apache Jct.			
Loser of Bout	210			

5	Chris Sclafani	13	-	7
	Jr Cactus Shad.			

7	Aulama Lemalu	15	-	22
	So Queen Creek			
216				

7	Aulama Lemalu	16	-	22
	So Queen Creek	Fall	Score	
		1:48	-	
276				

15	Ahmad, Teleb	8	-	12
	Jr Palo Verde			
Loser of Bout	209			

9	Cory Ferguson	9	-	13
	Jr Mingus			

2	BEN GARBETT	36	-	6
	SR CORTEZ	Fall	Score	
		0:22	-	
331				

13	Eric Mabes	24	-	11
	Sr Coconino	Fall	Score	
		8	-	3
361				

Loser of Bout	329			
---------------	-----	--	--	--

4	Robert Montano	19	-	6
	Sr Higley			

Loser of Bout	330			
---------------	-----	--	--	--

10	James Poug	20	-	11
	Washington			

11	Tim Harlan	18	-	18
	So Apache Jct.	Fall	Score	
		4:24	-	
362				

11	Tim Harlan	19	-	18
	So Apache Jct.	Fall	Score	
		2:00	-	
332				

7	Aulama Lemalu	17	-	22
	So Queen Creek	Fall	Score	
		3:58	-	

2	BEN GARBETT	37	-	6
	SR CORTEZ	Fall	Score	
		0:45	-	
361				

2	BEN GARBETT	38	-	6
	SR CORTEZ	Fall	Score	
		9	-	0
389				

Loser of Bout	329			
---------------	-----	--	--	--

4	Robert Montano	19	-	6
	Sr Higley			

Loser of Bout	330			
---------------	-----	--	--	--

10	James Poug	20	-	11
	Washington			

11	Tim Harlan	20	-	18
	So Apache Jct.	Fall	Score	
		4:03	-	
362				

11	Tim Harlan	19	-	18
	So Apache Jct.	Fall	Score	
		2:00	-	
332				

4	Robert Montano	19	-	7
	Sr Higley			
390				

4	Robert Montano	20	-	7
	Sr Higley	Fall	Score	
		17	-	0

10	James Poug	20	-	12
	Washington			

*Tim Harlan*

*Robert Montano*

2006 AIA 4A Division I State Wrestling

Weight Class

HWT

Consolation

16	BYE				
221					

9	Bouscher, Taylor	6	-	16
Fr	Palo Verde	Fall	Score	-
		Bye		
277				

9	Bouscher, Taylor	5	-	16
Fr	Palo Verde			
Loser of Bout 220				

7	Cody Taulton	17	-	4
Sr	Higley	Fall	Score	-
		1:42		

5	Chris Settanni	7	-	10
So	Mingus			
222				

5	Chris Settanni	8	-	10
So	Mingus	Fall	Score	-
		6		0
278				

13	Fair, Mike	17	-	10
Sr	Cholla			
Loser of Bout 219				

5	Chris Settanni	9	-	10
So	Mingus	Fall	Score	-
		1:41		

11	Ian Spencer	20	-	18
So	Queen Creek			

14	Jeremy Smith	16	-	19
So	Flagstaff			
223				

6	Chris Daniels	6	-	6
So	Sunnyslope	Fall	Score	-
		1:45		
279				

6	Chris Daniels	5	-	6
So	Sunnyslope			
Loser of Bout 218				

12	Kelland Brookevr	34	-	10
SO	Buckeye	Fall	Score	-
		1:59		

10	Andrew Crook	9	-	15
Jr	Cococino			
224				

15	Cody Pinkerton	9	-	5
Jr	Cactus Shad.	Fall	Score	-
		0:16		
280				

15	Cody Pinkerton	8	-	5
Jr	Cactus Shad.			
Loser of Bout 217				

8	MILTON WOOD	16	-	9
	DESERT EDGE	Fall	Score	-
		1:54		

8	MILTON WOOD	15	-	9
	DESERT EDGE			

5	Chris Settanni	10	-	10
So	Mingus	Fall	Score	-
		7		0
363				

4	Zach Tourangeau	21	-	8
Jr	Apache Jct.			
Loser of Bout 333				

3	Butierrez, Eddie	27	-	9
Sr	Desert View			
Loser of Bout 334				

12	Kelland Brookevr	34	-	10
SO	Buckeye	Fall	Score	-
		1:59		

12	Kelland Brookevr	35	-	10
SO	Buckeye	Fall	Score	-
		2:38		

4	Zach Tourangeau	22	-	8
Jr	Apache Jct.	Fall	Score	-
		0:28		

4	Zach Tourangeau	23	-	8
Jr	Apache Jct.	Fall	Score	-
		0:42		

3	Butierrez, Eddie	28	-	9
Sr	Desert View	Fall	Score	-
		2:56		

5	Chris Settanni	10	-	11
So	Mingus			
392				

*Thomas Place*

*Thomas Place*

12	Kelland Brookevr	36	-	11
SO	Buckeye	Fall	Score	-
		10		3

Tuesday  
1/31/06

Tuesday  
1/31/06

Wednesday  
2/01/06

Wednesday  
2/01/06

Updated: 02/02/06: bb  
Prior Update: 01/31/06: bb  
Original Post: 12/23/05: bb

# 2006 AIA 5A Div. I State Wrestling Team Tournament



#1 Mesa Mtn. View				
Site: Mesa Mtn. View 6:00 pm	#1 Mesa Mtn. View (65-9)			
#16 Mountain Pointe	Site: Mesa Mtn. View 8:00 pm	#1 Mesa Mtn. View (66-3)		
#8 Cesar Chavez	#9 Dobson (40-20)			
Site: Mesa Mtn. View 6:00 pm		Site: Mesa Mtn. View H.S. 6:00 pm	#1 Mesa Mtn. View (42-21)	
#9 Dobson				
#5 Highland	#5 Highland (40-27)	#5 Highland (33-31)		
Site: Corona del Sol 6:00 pm	Site: Corona del Sol 8:00 pm			
#12 Cibola	#4 Corona del Sol (47-12)			
#4 Corona del Sol				
Site: Corona del Sol 6:00 pm				
#13 Basha				#2 Mesa (38-23)
#3 Red Mountain	#3 Red Mountain (50-15)			
Site: Red Mountain 6:00 pm	Site: Red Mountain 8:00 pm	#6 Desert Vista (31-22)		
#14 Casa Grande	#6 Desert Vista (54-7)			
#6 Desert Vista				
Site: Red Mountain 6:00 pm		Site: Mesa Mtn. View H.S. 6:00 pm	#2 Mesa (38-24)	
#11 Westwood				
#7 Horizon	#7 Horizon (37-27)			
Site: Mesa 6:00 pm	Site: Mesa 8:00 pm	#2 Mesa (57-9)		
#10 Mesquite	#2 Mesa (73-6)			
#2 Mesa				
Site: Mesa 6:00 pm				
#15 Buena				



Teams may weigh-in 2 wrestlers per weight class (maximum of 28 wrestlers). All wrestlers **must** weigh-in first day of tournament to be eligible to compete on the second day of the tournament.

**SITE: High Seed or in the area of highest seed**



# 5A State Wrestling Division I Arizona February 2006

Weight: 103

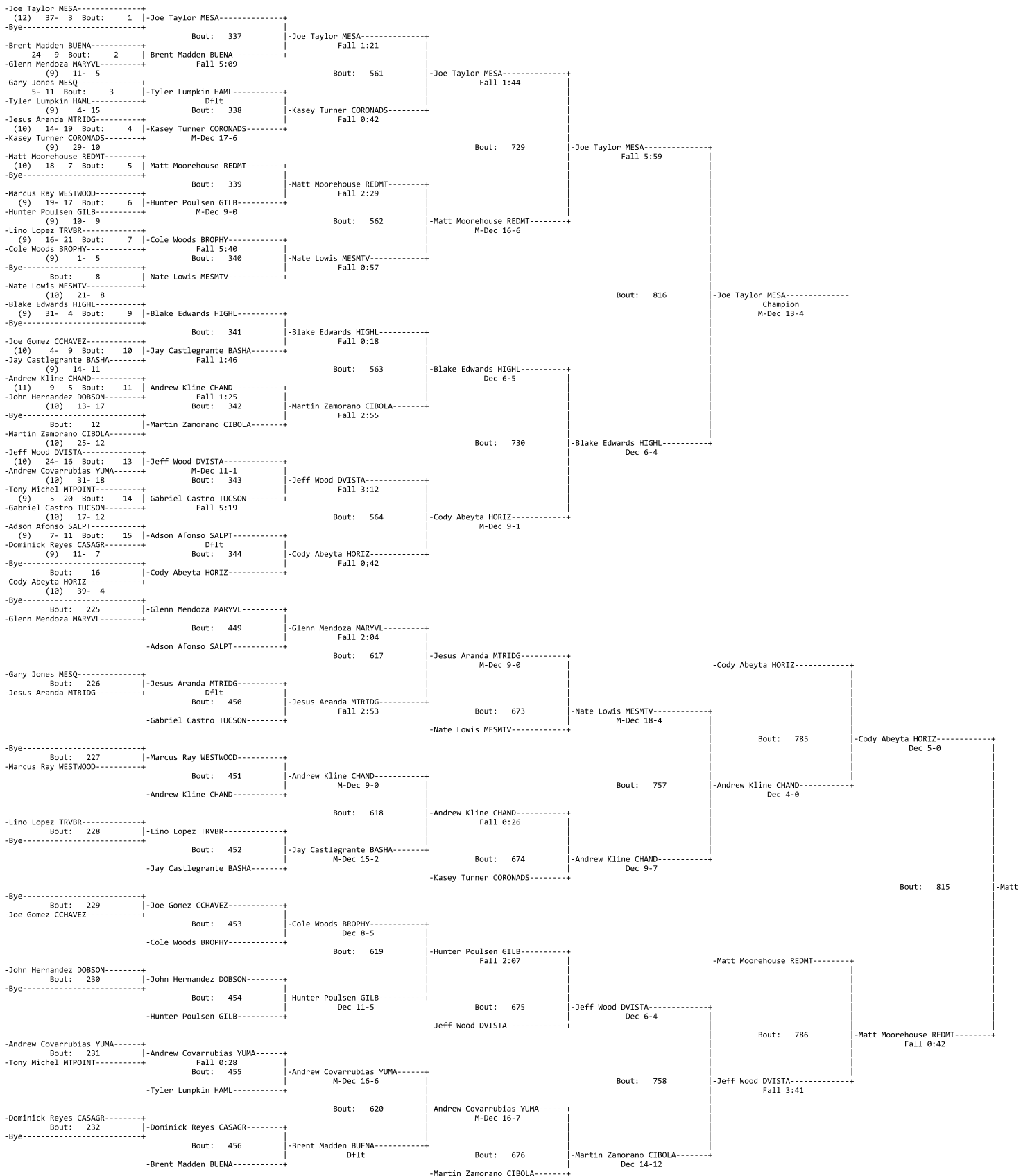

-Andrew Kline CHAND-----+  
 Bout: 814 | -Jeff Wood DVISTA-----+  
 -Jeff Wood DVISTA-----+  
 5th Place  
 M-Dec 15-4

- Place Winners -  
 1st Joe Taylor MESA (12) 41- 3  
 2nd Blake Edwards HIGHL (9) 34- 5  
 3rd Matt Moorehouse REDMT (10) 22- 8  
 4th Cody Abeyta HORIZ (10) 42- 6

- Place Winners -  
 5th Jeff Wood DVISTA (10) 29- 18  
 6th Andrew Kline CHAND (11) 14- 8

Weight: 112

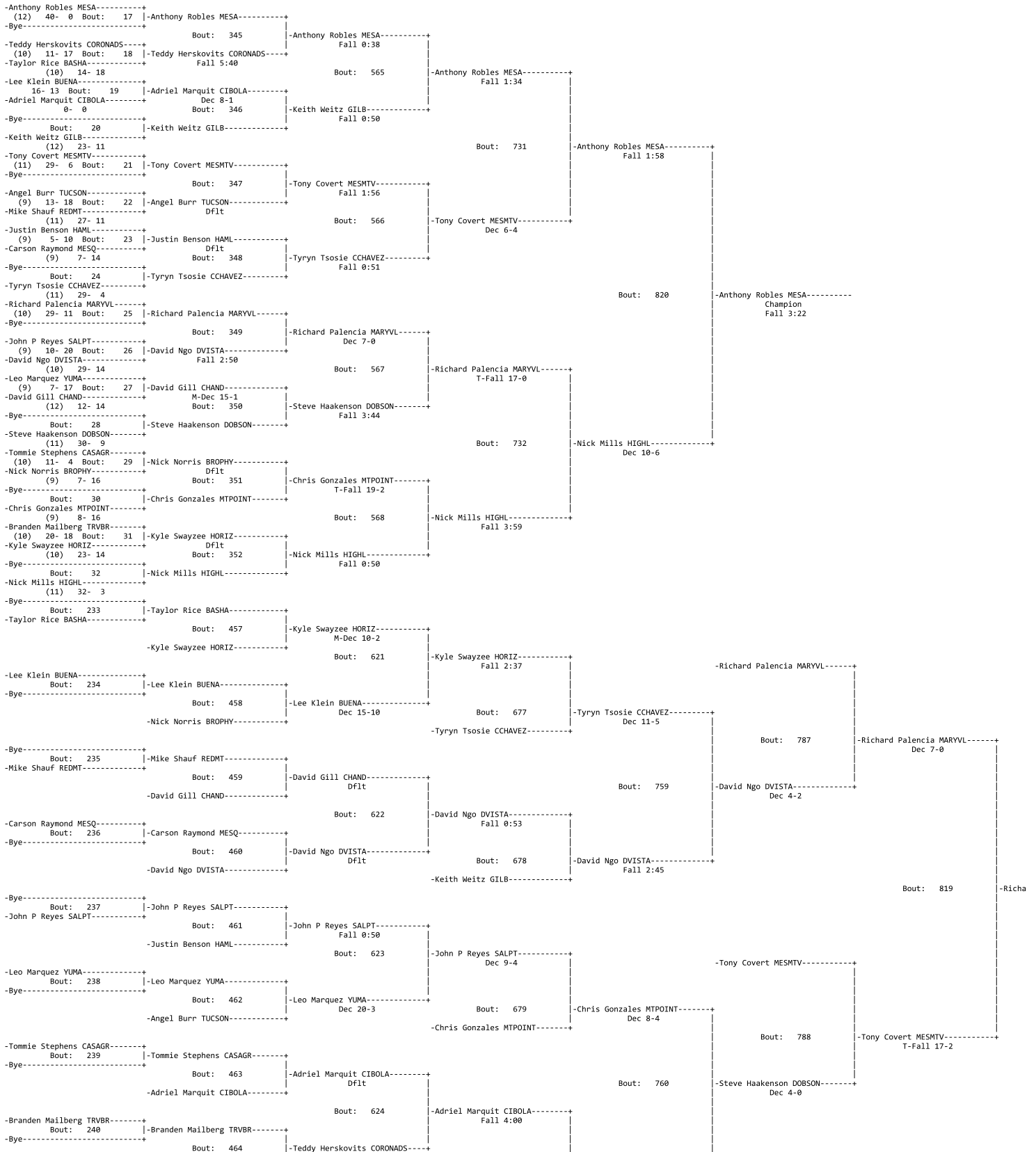

-Teddy Herskovits CORONADS-----+ Bout: 680	Dflit	-Steve Haakenson DOBSON-----+ Dec 5-1			
-Steve Haakenson DOBSON-----+ Bout: 818				-David Ngo DVISTA-----+ Bout: 818	-Steve Haakenson DOBSON-----+ 5th Place Dec 3-2
	- Place Winners -			- Place Winners -	
	1st Anthony Robles MESA (12) 44- 0			5th Steve Haakenson DOBSON (11) 34- 11	
	2nd Nick Mills HIGHL (11) 35- 4			6th David Ngo DVISTA (10) 34- 17	
	3rd Richard Palencia MARYVL (10) 33- 12				
	4th Tony Covert MESMTV (11) 32- 8				

Weight: 119

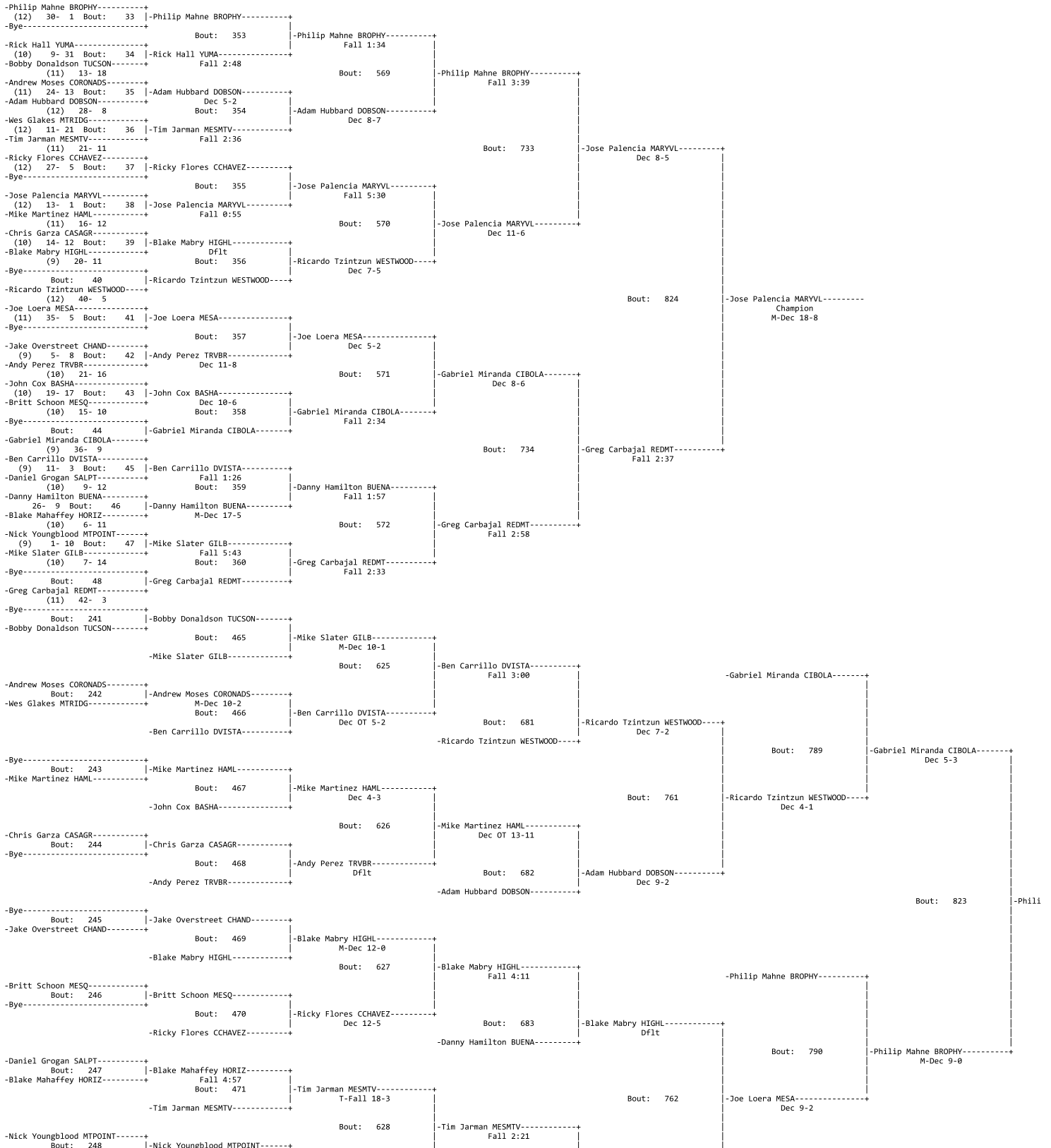

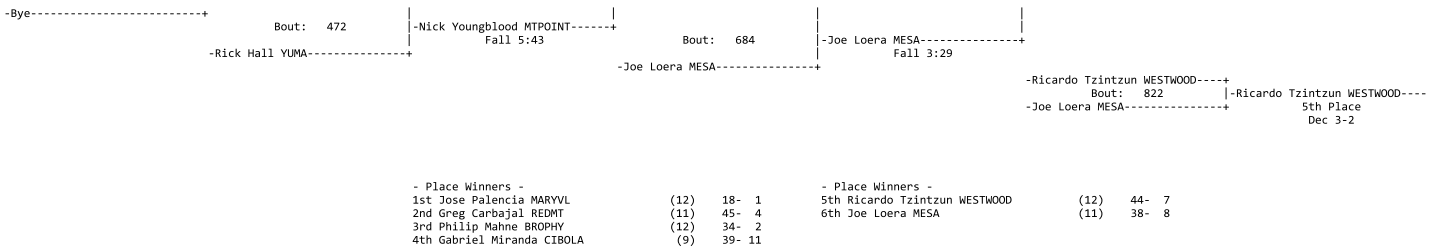

Weight: 125

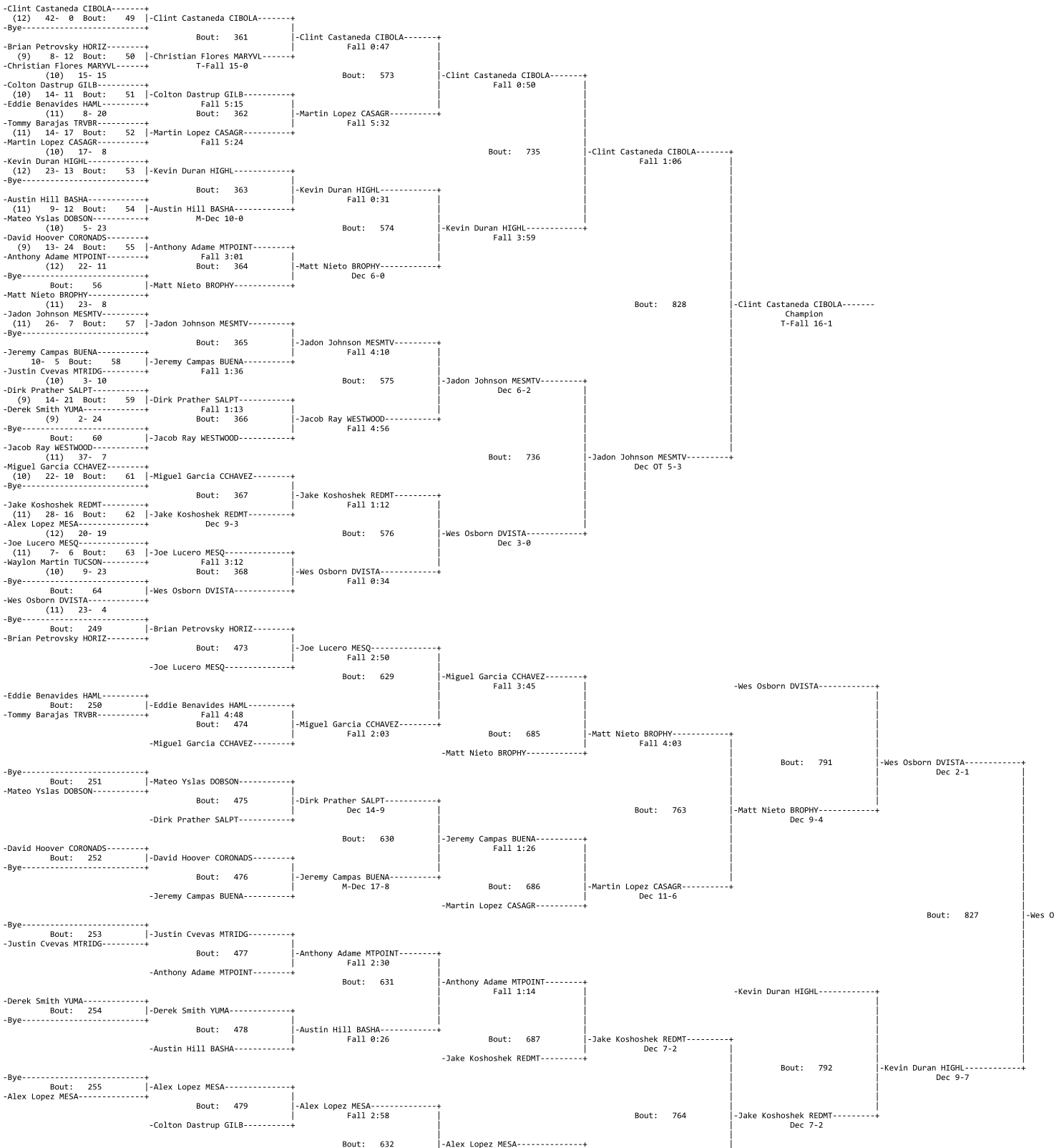

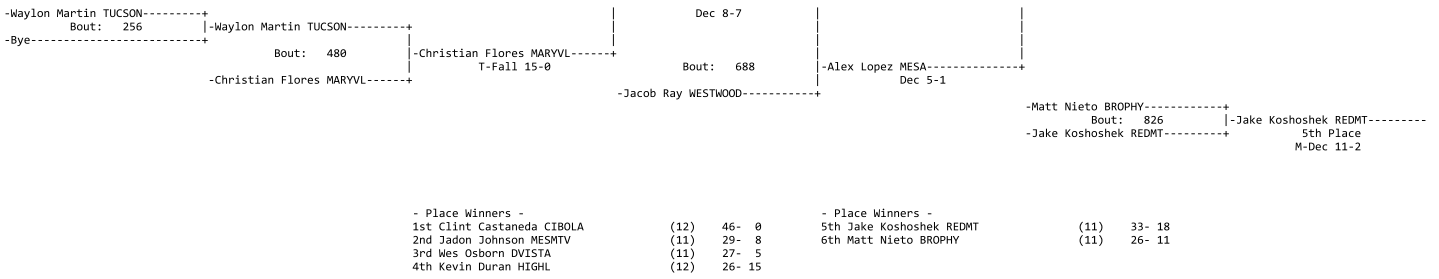

Weight: 130

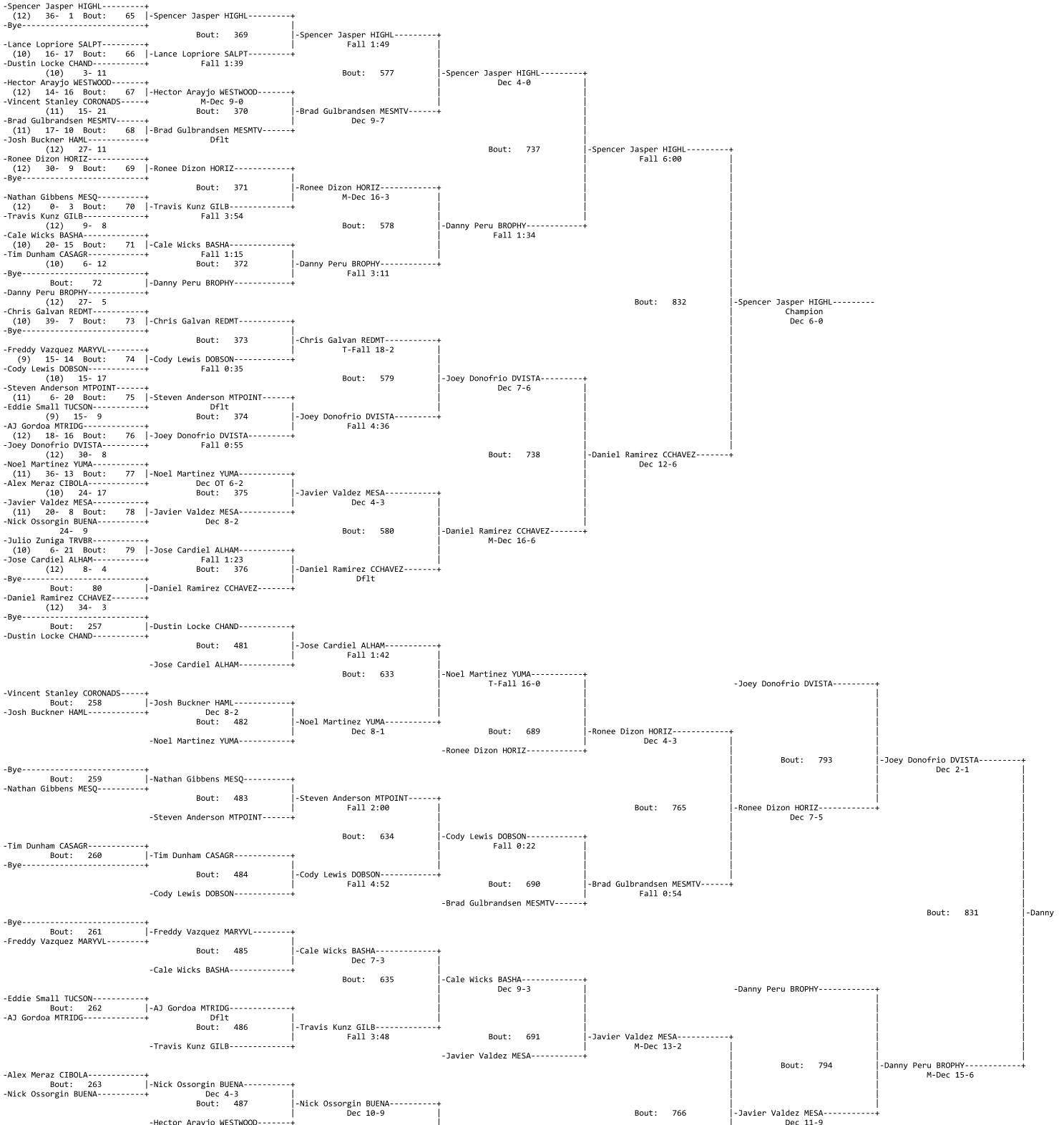

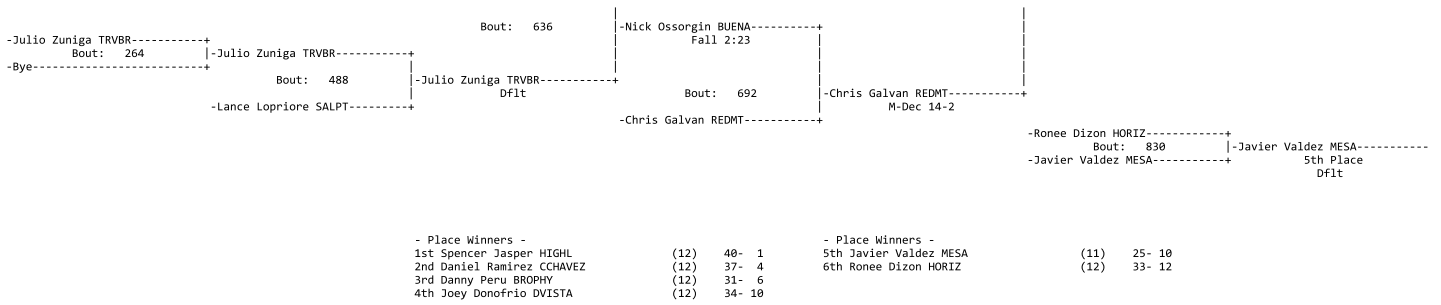

Weight: 135

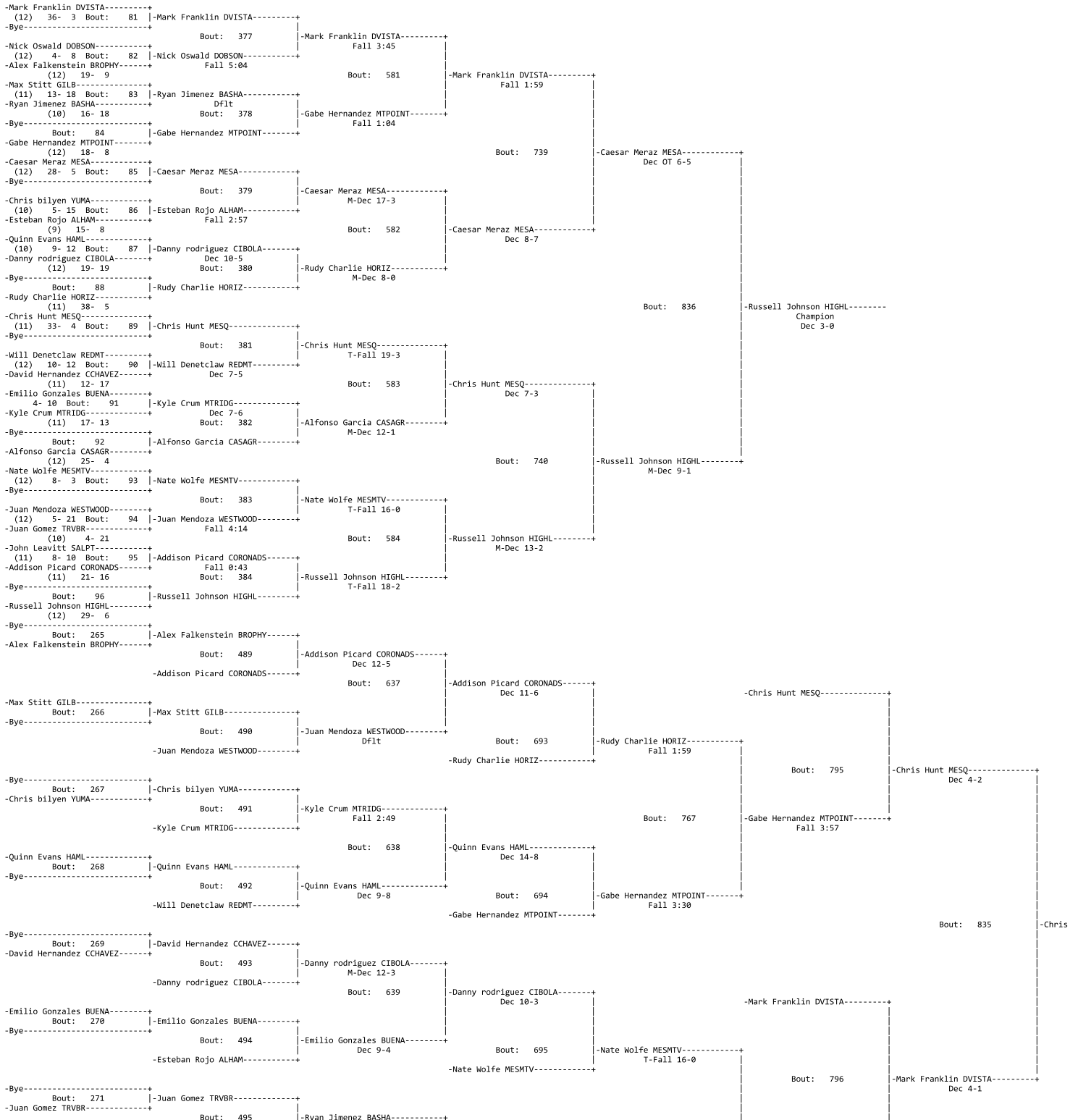

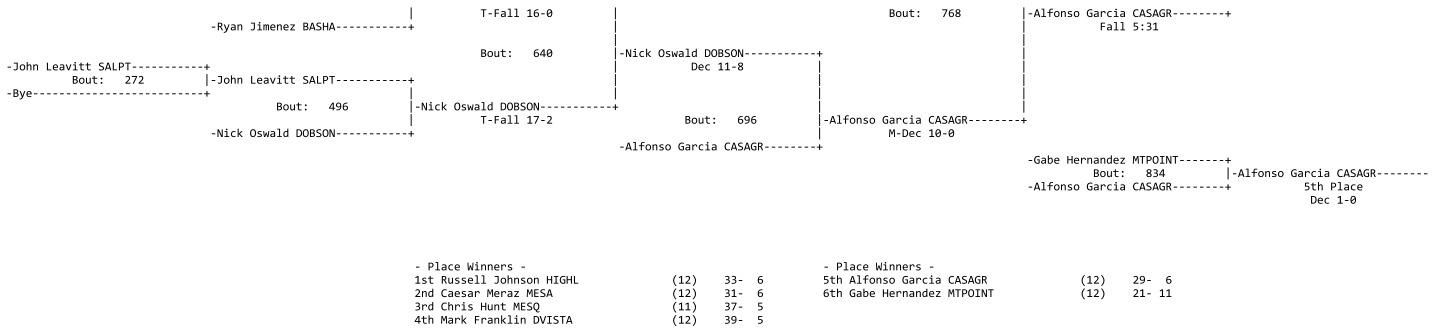

Weight: 140

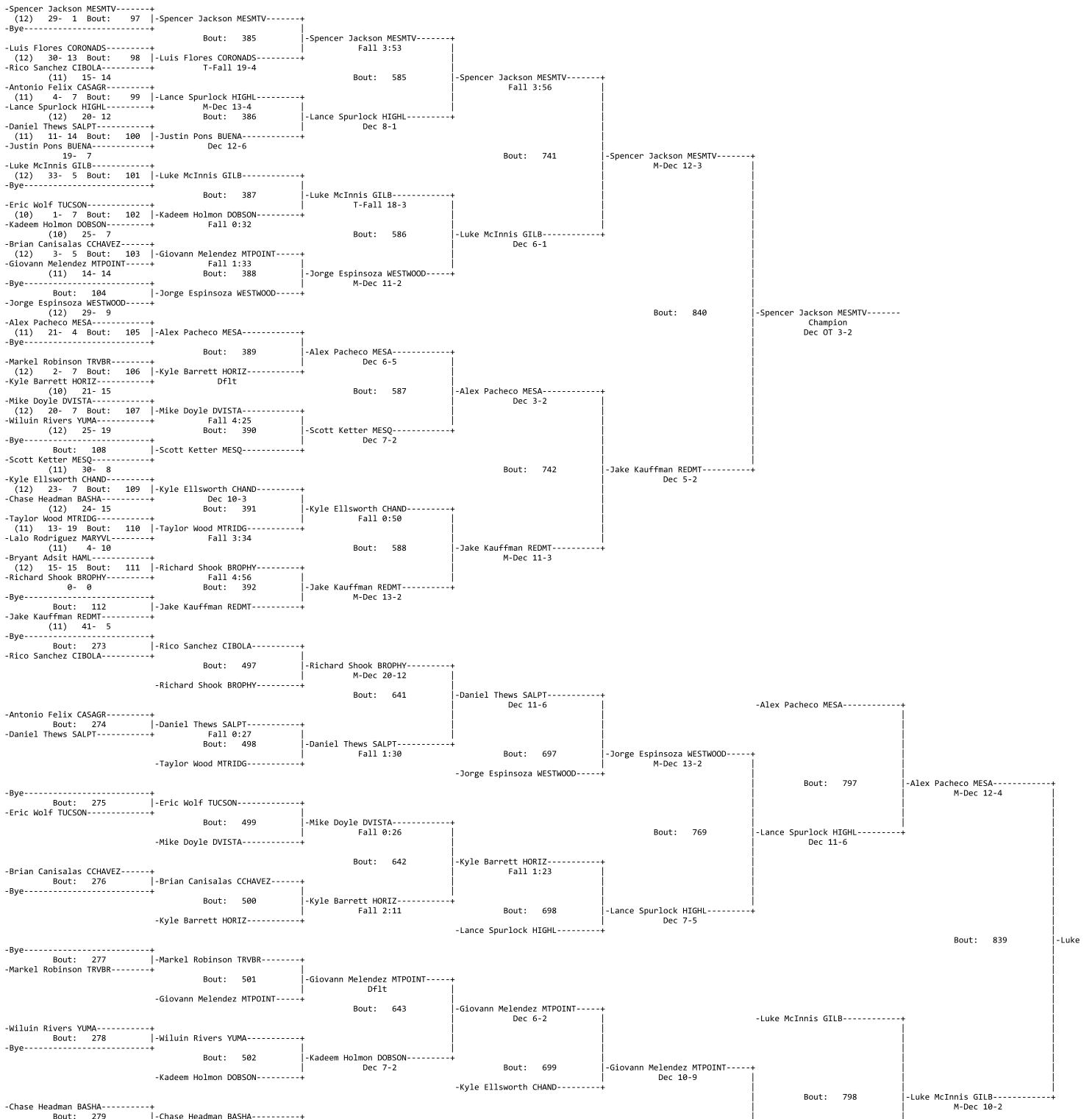

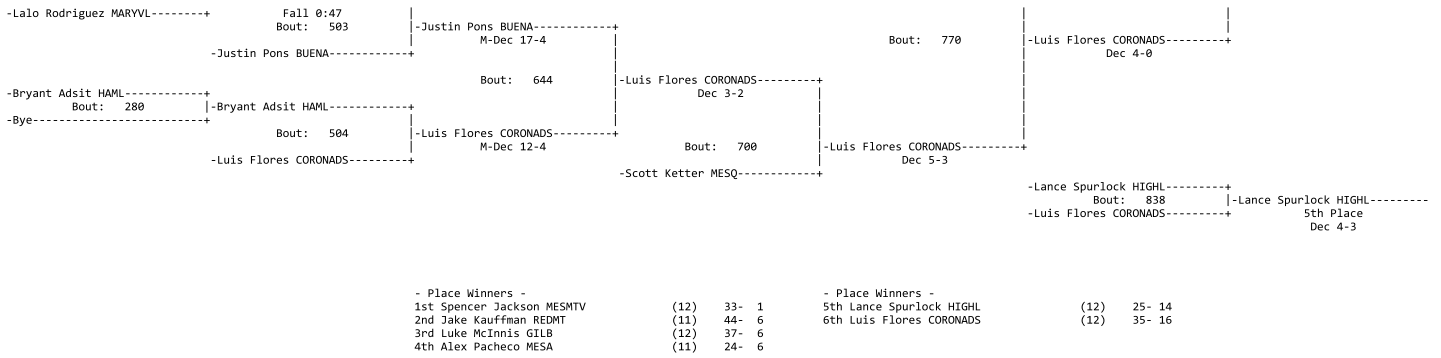

**Weight: 145**





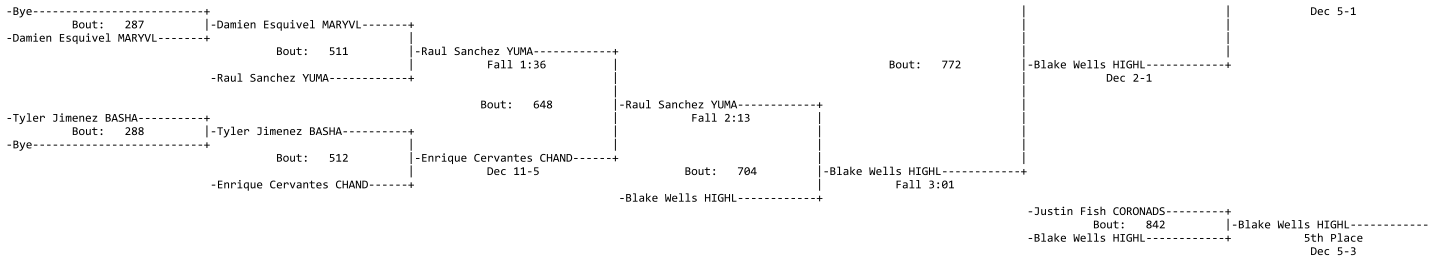

- Place Winners -			- Place Winners -	
1st Justin Castillo MESMTV	(12)	31- 1	5th Blake Wells HIGHL	(12) 33- 10
2nd Joel Williams DOBSON	(12)	37- 2	6th Justin Fish CORONADS	(12) 36- 15
3rd Anthony Gonzales MTPOINT	(12)	26- 3		
4th Jacob Langkilde MESA	(12)	29- 5		

Weight: 152

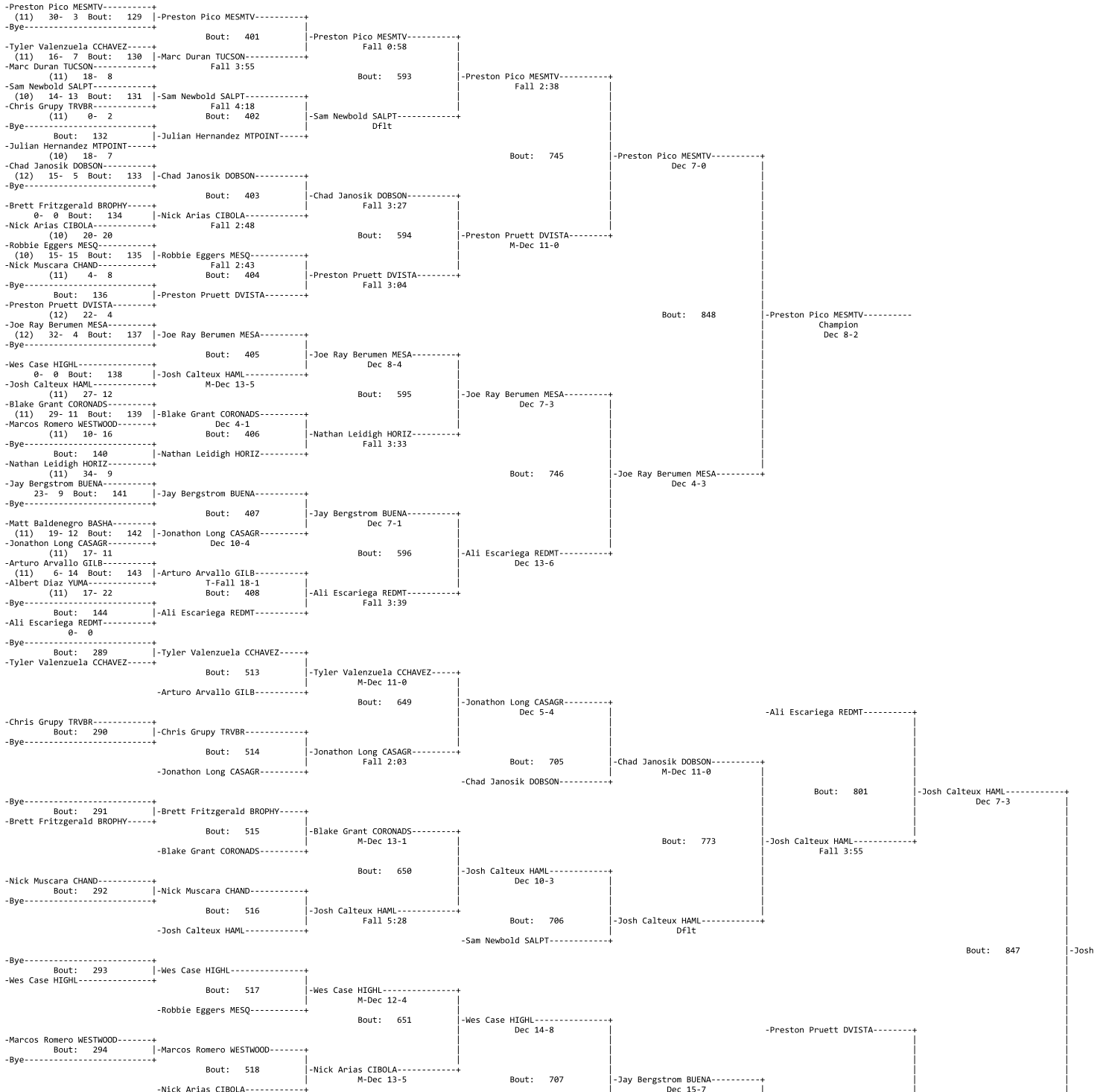

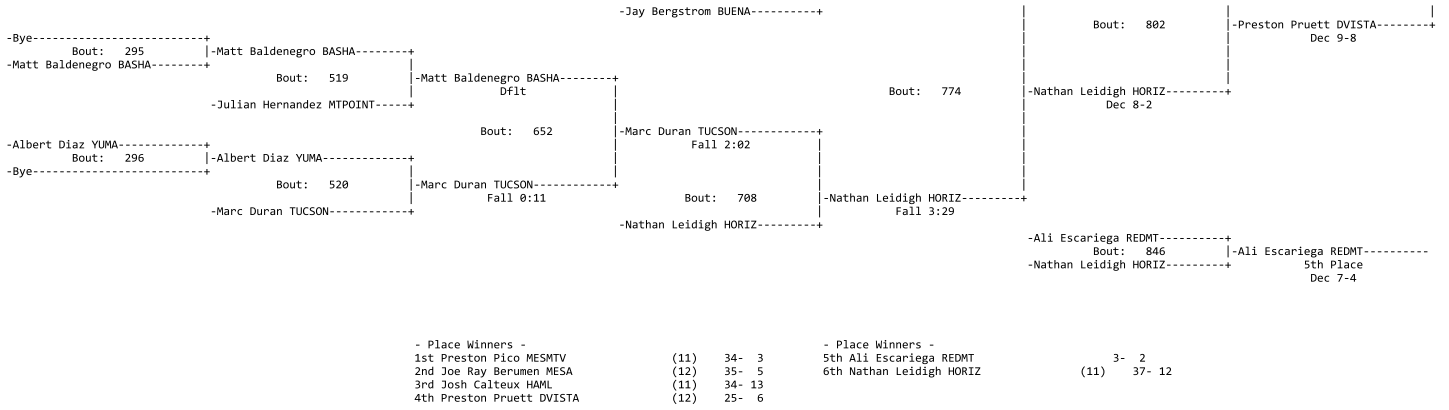

Weight: 160

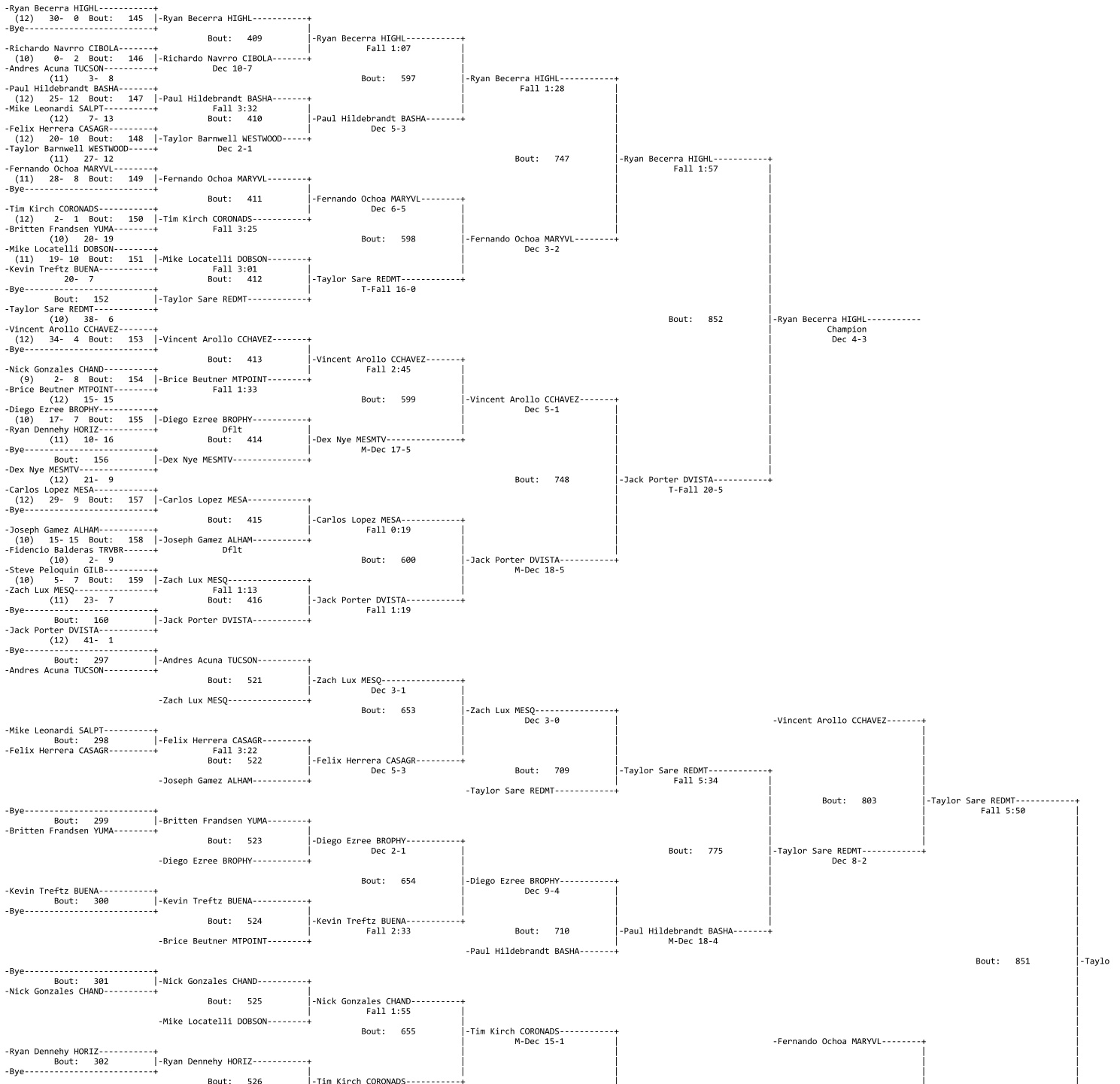

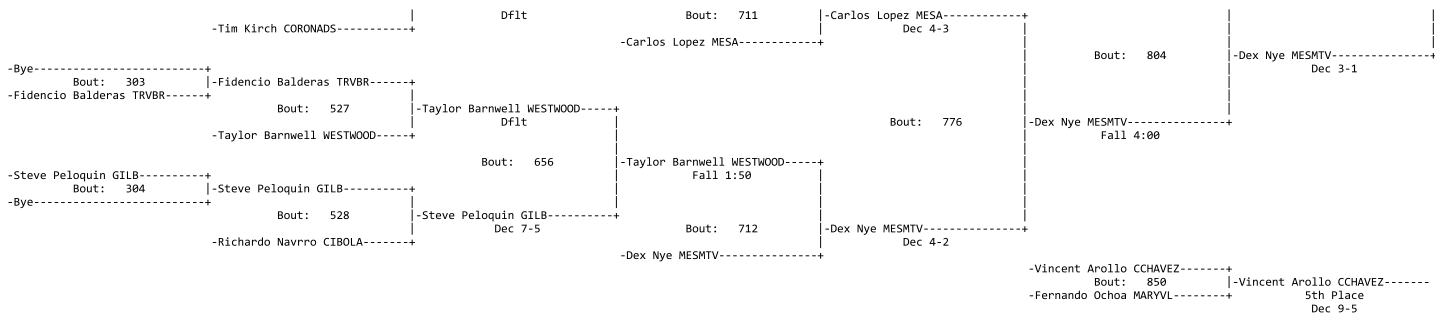

- Place Winners -

- 1st Ryan Becerra HIGHL
- 2nd Jack Porter DVISTA
- 3rd Taylor Sare REDMT
- 4th Dex Nye MESMTV

- (12) 34- 0
- (12) 44- 2
- (10) 43- 7
- (12) 25- 11

- Place Winners -

- 5th Vincent Arollo CCHAVEZ
- 6th Fernando Ochoa MARYVL

- (12) 37- 6
- (11) 30- 11

Weight: 171

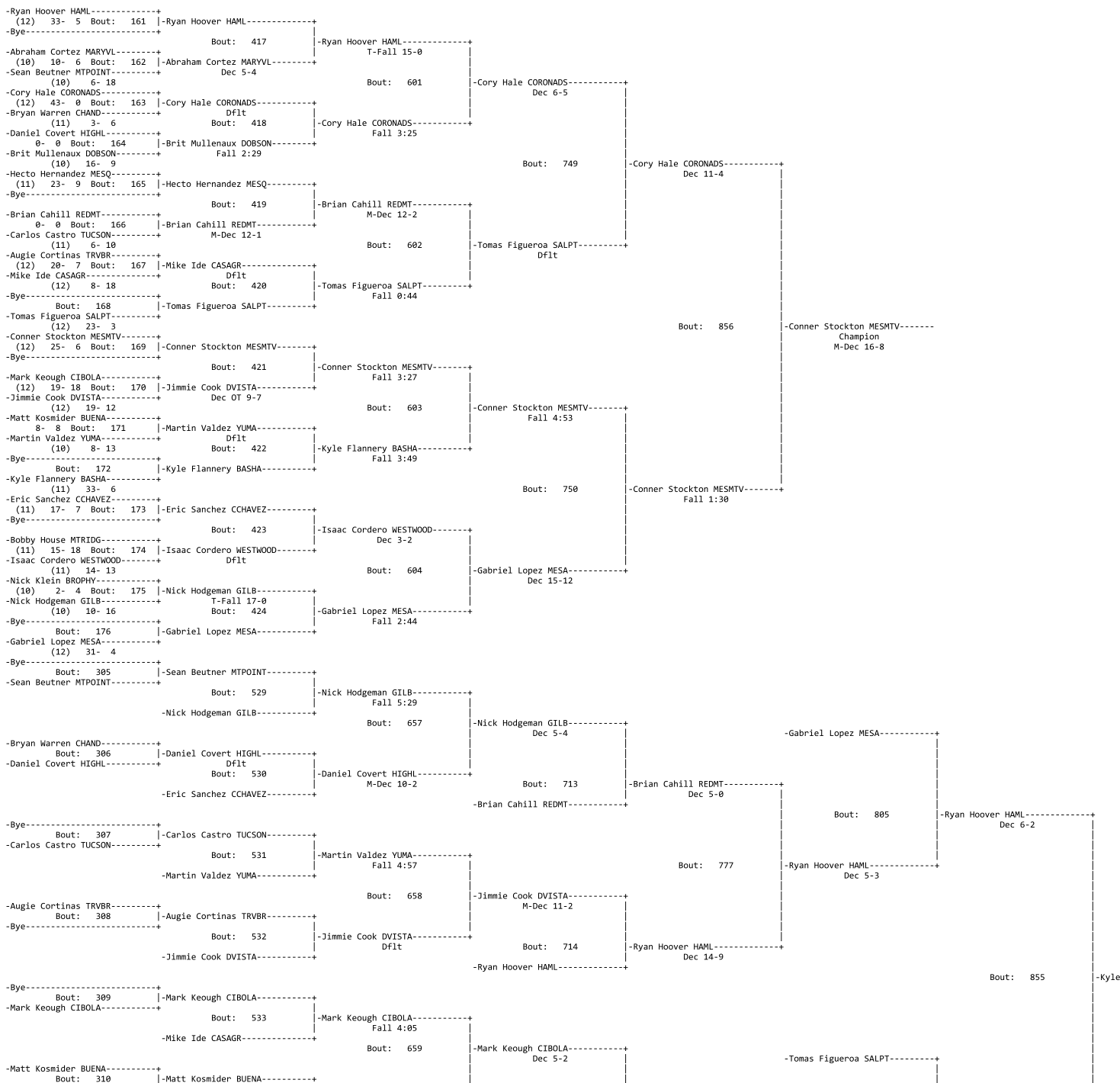

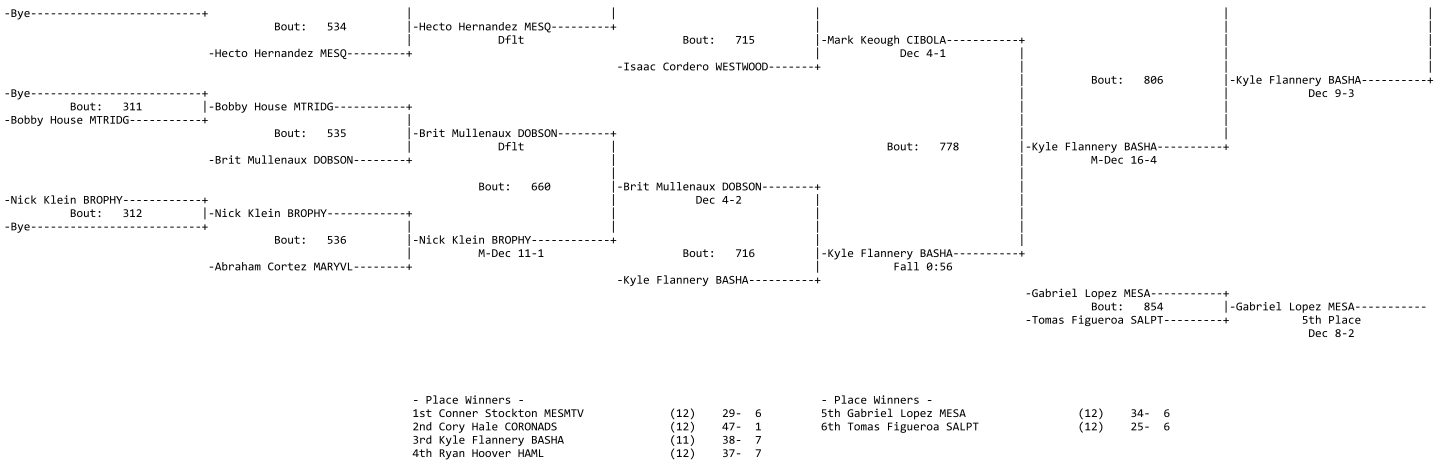

Weight: 189

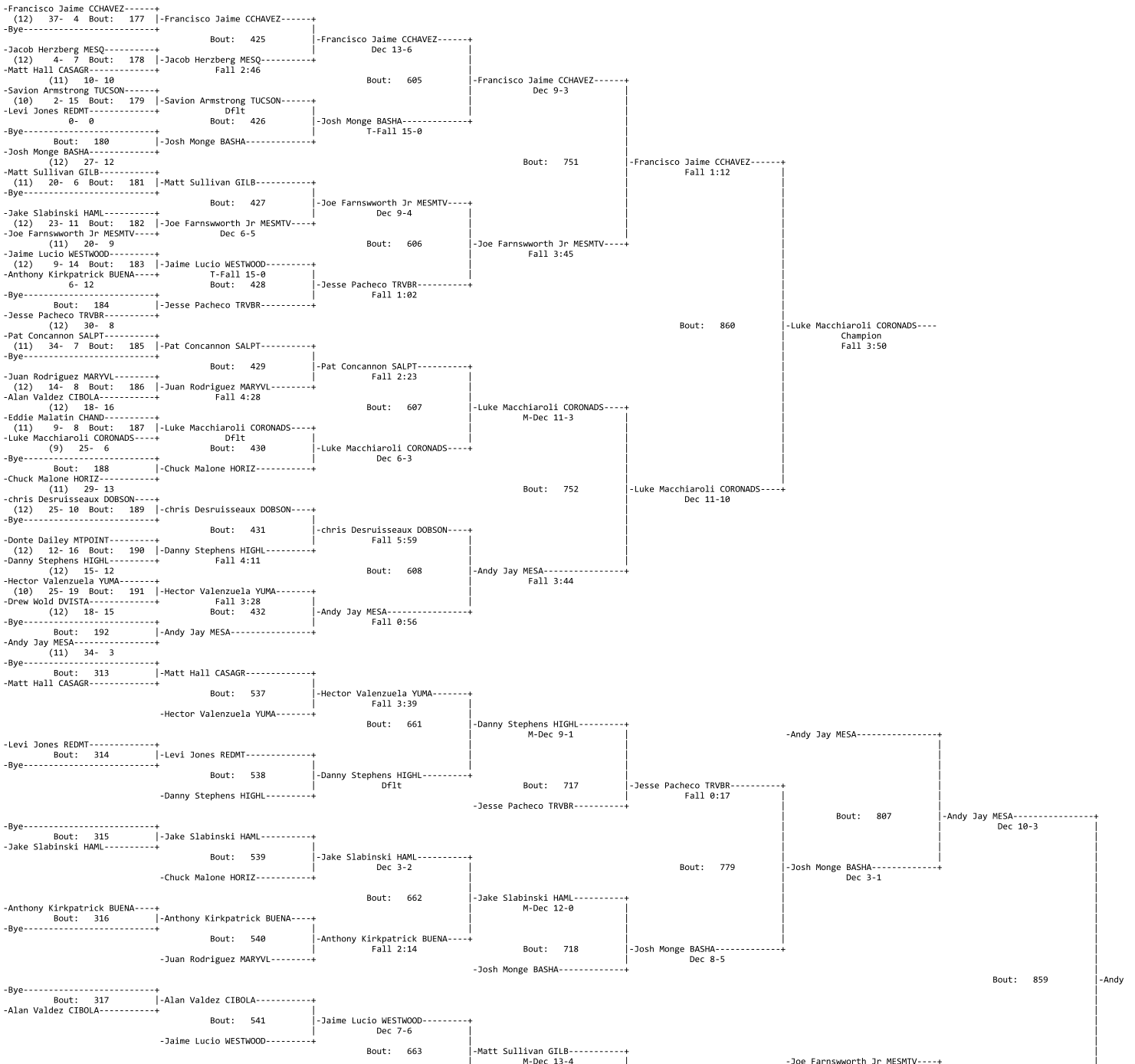

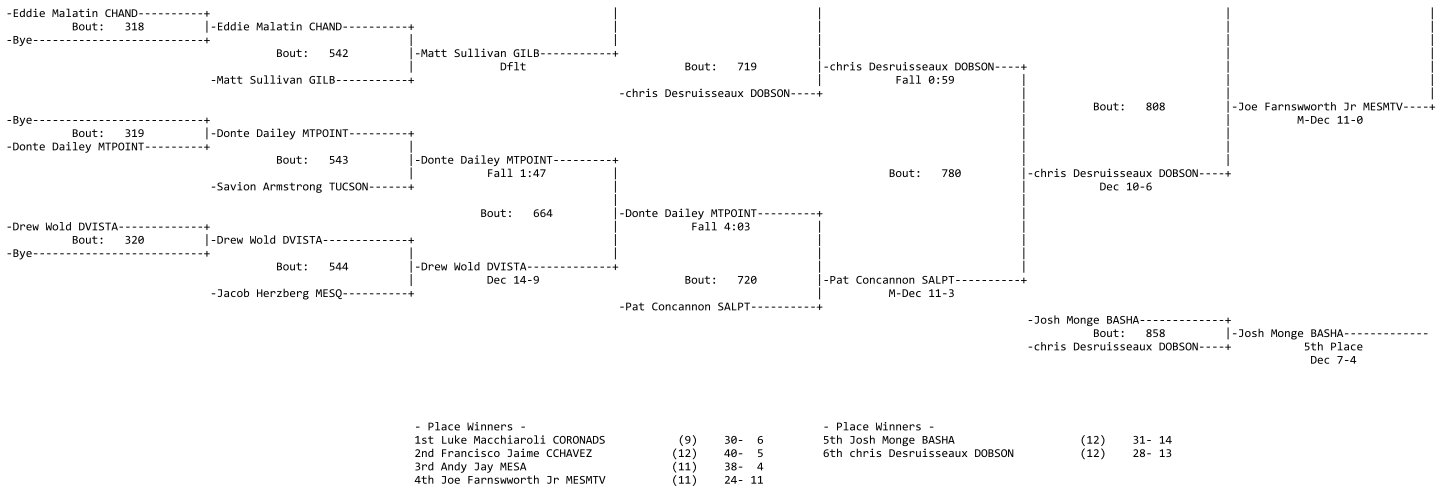

Weight: 215

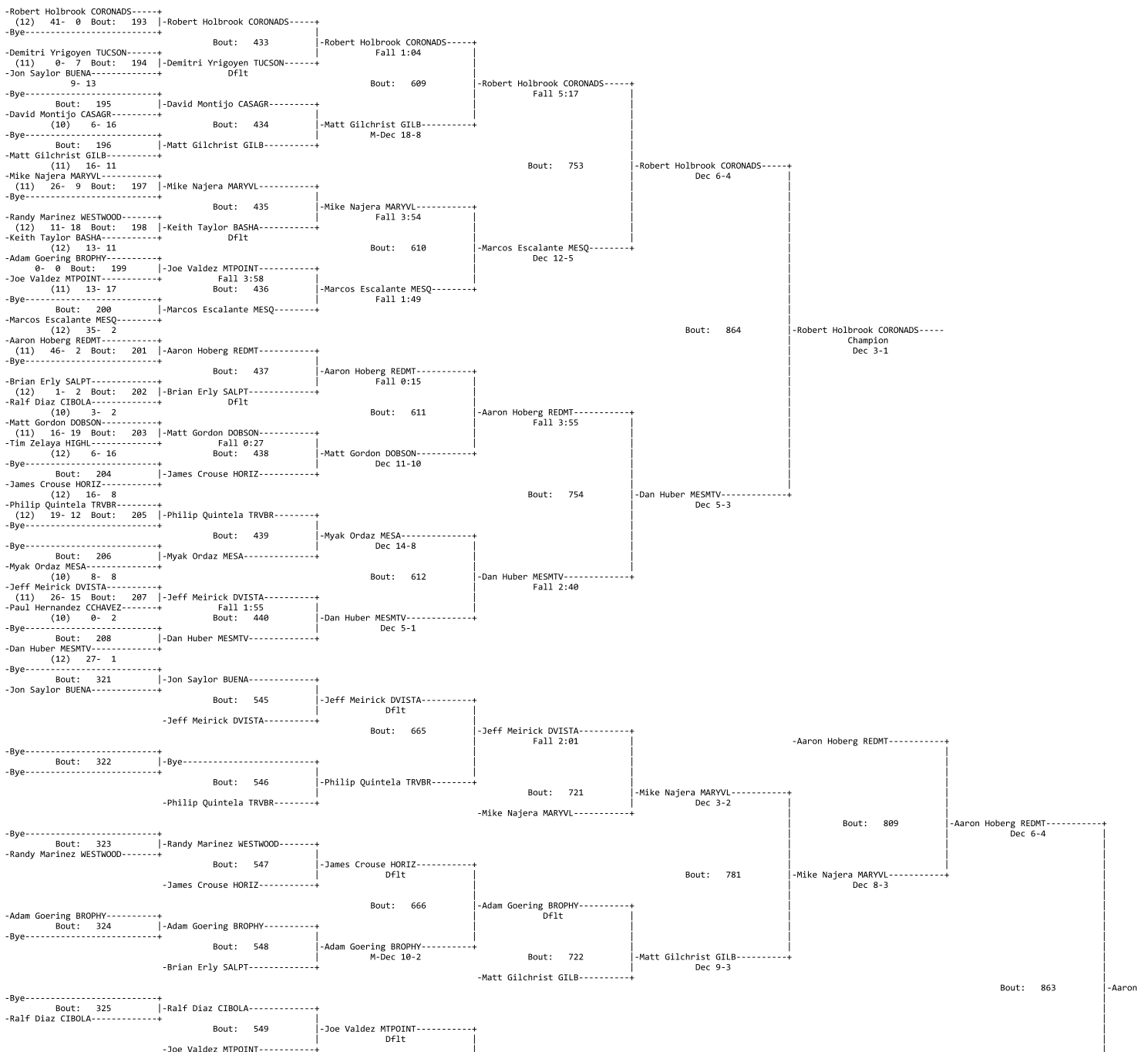

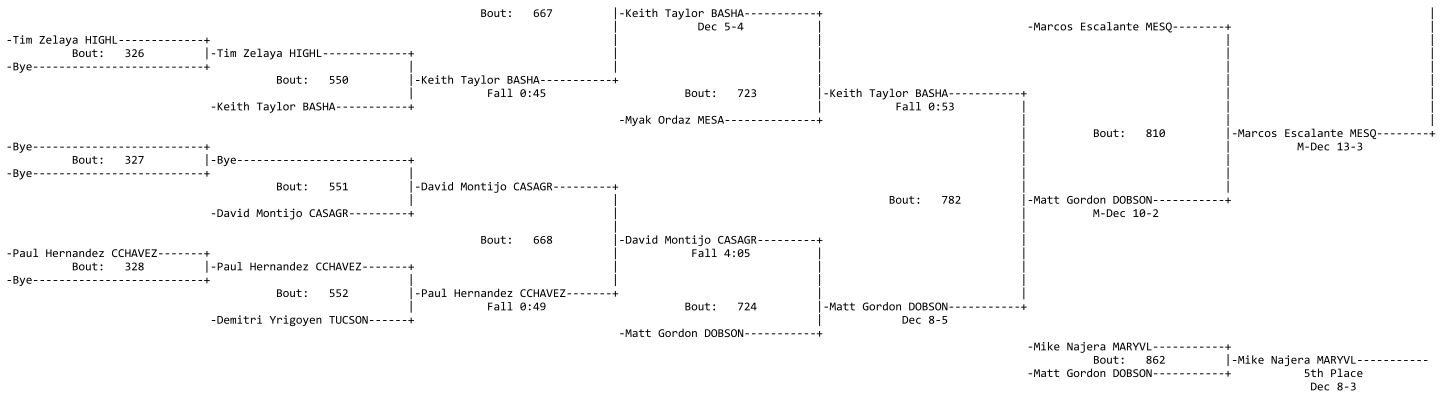

- Place Winners -  
 1st Robert Holbrook CORONADS  
 2nd Dan Huber MESMTV  
 3rd Aaron Hoberg REDMT  
 4th Marcos Escalante MESQ

(12) 45- 0  
 (12) 30- 2  
 (11) 50- 3  
 (12) 38- 4

- Place Winners -  
 5th Mike Najera MARYVL  
 6th Matt Gordon DOBSON

(11) 30- 11  
 (11) 20- 22

Weight: 275

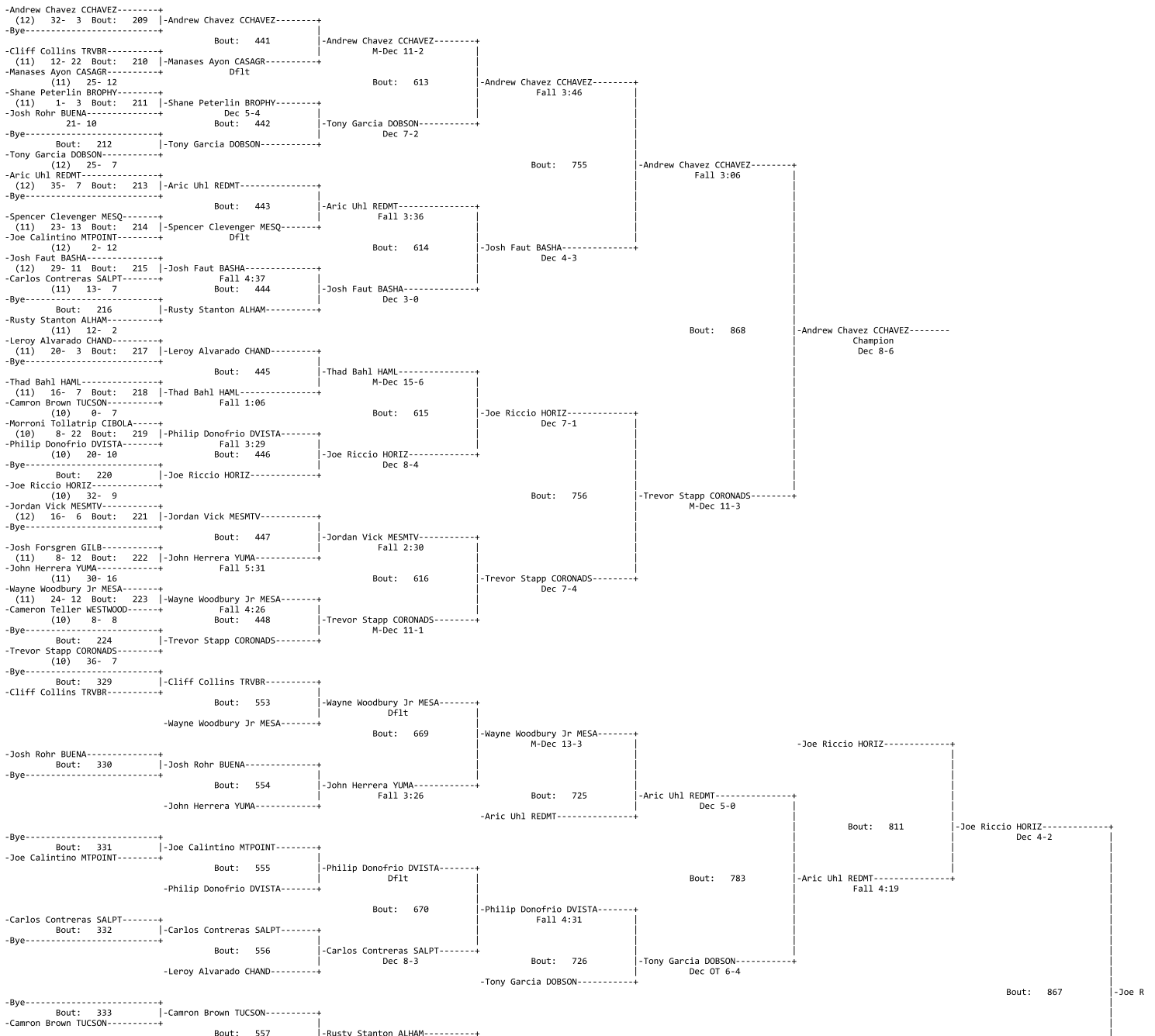

Brackets

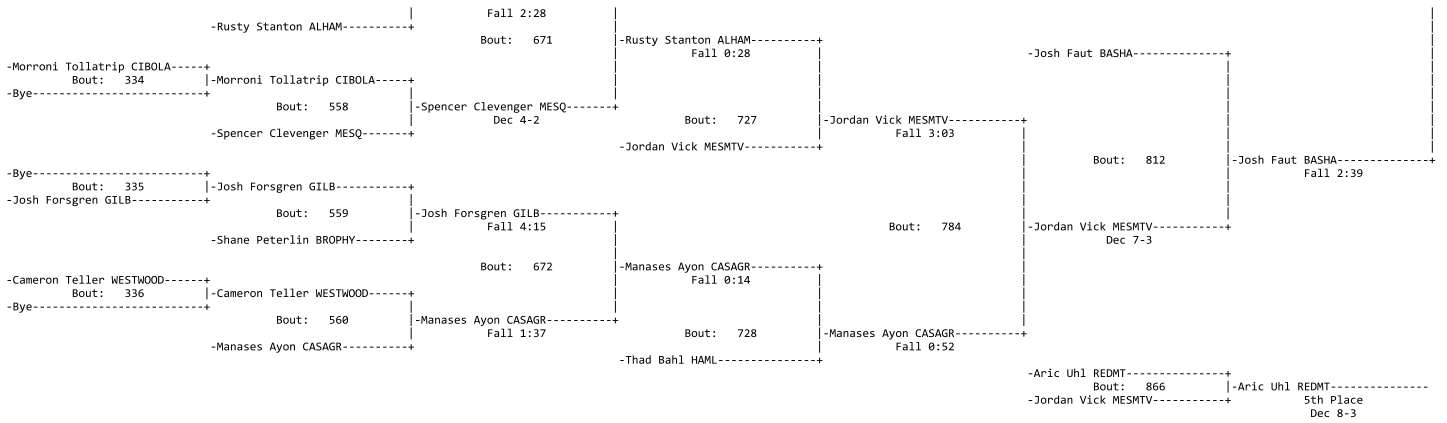

- Place Winners -  
 1st Andrew Chavez CCHAVEZ  
 2nd Trevor Stapp CORONADS  
 3rd Joe Riccio HORIZ  
 4th Josh Faut BASHA

(12) 36- 3  
 (10) 39- 8  
 (10) 36- 10  
 (12) 33- 13

- Place Winners -  
 5th Aric Uhl REDMT  
 6th Jordan Vick MESMTV

(12) 39- 9  
 (12) 19- 9

Preferred Educational Software

9585 Woodgate Lane  
 Byron IL 61010  
 Phone: (888) 959-2016  
 e-mail: [cotterk@pes-sports.com](mailto:cotterk@pes-sports.com)

(c) 2001 - All rights reserved

Tuesday  
1/31/06

Tuesday  
1/31/06

Wednesday  
2/01/06

Wednesday  
2/01/06

Updated: 02/01/06: bb  
Prior Update: 01/31/06: bb  
Original Post: 12/23/05: bb

# 2006 AIA 5A Div. II State Wrestling Team Tournament



#1 Sunnyside  
(44-19)



Arizona Interscholastic Association, Inc.

State Champion

Teams may weigh-in 2 wrestlers per weight class (maximum of 28 wrestlers). All wrestlers **must** weigh-in first day of tournament to be eligible to compete on the second day of the tournament.

SITE: High Seed of in the area of highest seed

#1 Sunnyside  
Site: Sunnyside  
6:00 pm  
#16 Carl Hayden

#1 Sunnyside  
(76-6)

#8 Flowing Wells  
Site: Sunnyside  
6:00 pm  
#9 Ironwood

Site: Sunnyside  
8:00 pm  
#9 Ironwood  
(48-27)

#1 Sunnyside  
(76-3)

#5 Deer Valley  
Site: Kofa  
6:00 pm  
#12 Desert Ridge

#5 Deer Valley  
(60-3)

Site: Sunnyside H.S.  
6:00 pm  
#4 Kofa  
(54-13)

#4 Kofa  
Site: Kofa  
6:00 pm  
#13 Westview

Site: Kofa  
8:00 pm  
#4 Kofa  
(54-16)

#1 Sunnyside  
(56-10)  
Site: Sunnyside H.S.  
8:00 pm

#3 Marcos de Niza  
Site: Marcos de Niza  
6:00 pm  
#14 Central

#3 Marcos de Niza  
(57-9)

#3 Marcos de Niza  
(49-17)

#6 Sunrise Mountain  
Site: Marcos de Niza  
6:00 pm  
#11 Barry Goldwater

Site: Marcos de Niza  
8:00 pm  
#6 Sunrise Mountain  
(64-16)

#3 Marcos de Niza  
(38-30)

#7 Centennial  
Site: Marana Mtn. View  
6:00 pm  
#10 Desert Mountain

#7 Centennial  
(42-33)

Site: Sunnyside H.S.  
6:00 pm  
#2 Marana Mtn. View  
(47-24)

#2 Marana Mtn. View  
Site: Marana Mtn. View  
6:00 pm  
#15 Boulder Creek

Site: Marana Mtn. View  
8:00 pm  
#2 Marana Mtn. View  
(70-12)



# 5A State Wrestling Division II Arizona February 2006

## Weight: 103

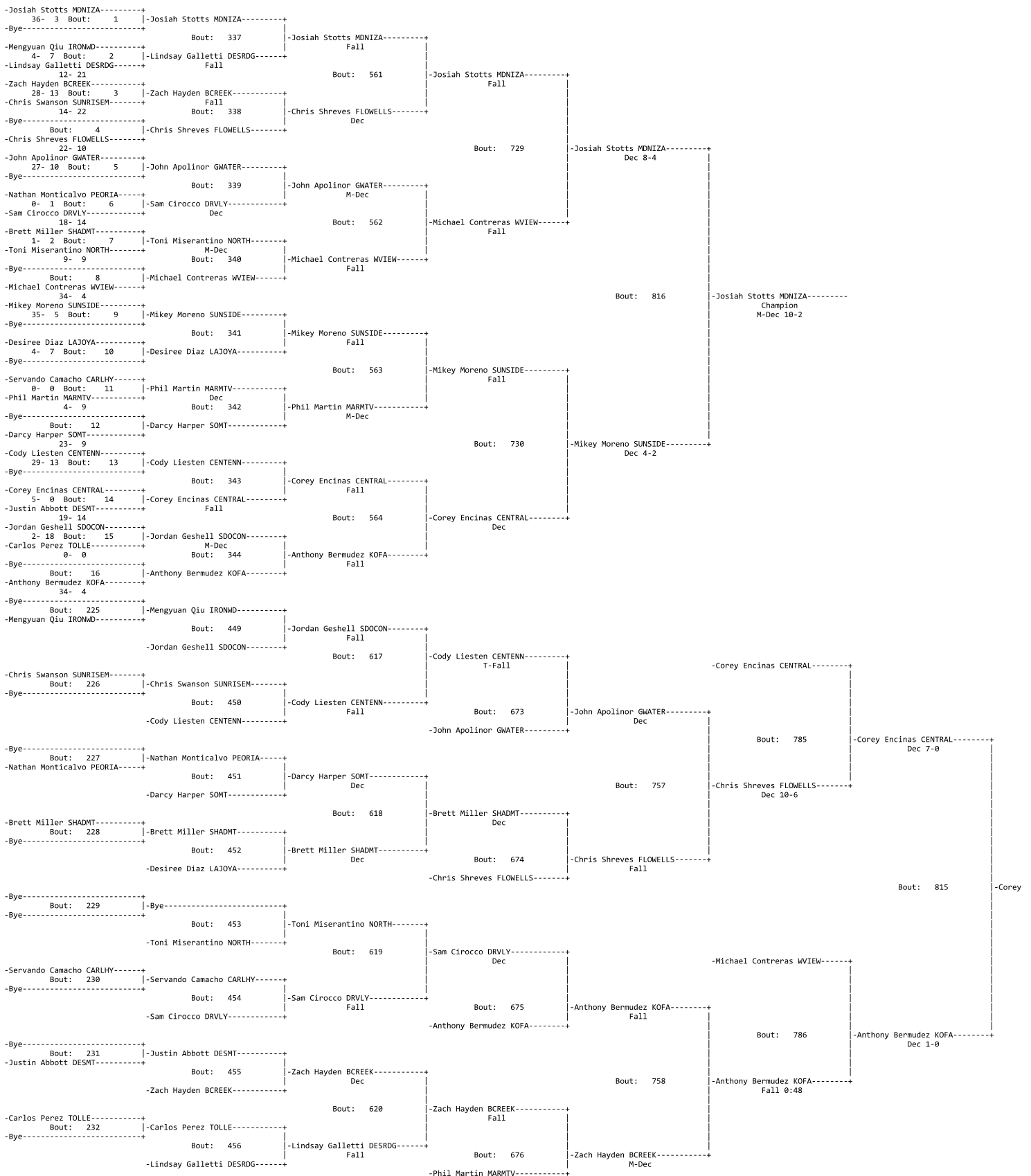

-Chris Shreves FLOWELLS-----+  
 Bout: 814 | -Michael Contreras WVIEW-----  
 -Michael Contreras WVIEW-----+  
 5th Place  
 M-Dec 17-6

- Place Winners -  
 1st Josiah Stotts MDNIZA 40- 3  
 2nd Mikey Moreno SUNSIDE 38- 6  
 3rd Corey Encinas CENTRAL 10- 1  
 4th Anthony Bermudez KOFA 38- 6

- Place Winners -  
 5th Michael Contreras WVIEW 37- 6  
 6th Chris Shreves FLOWELLS 25- 13

Weight: 112

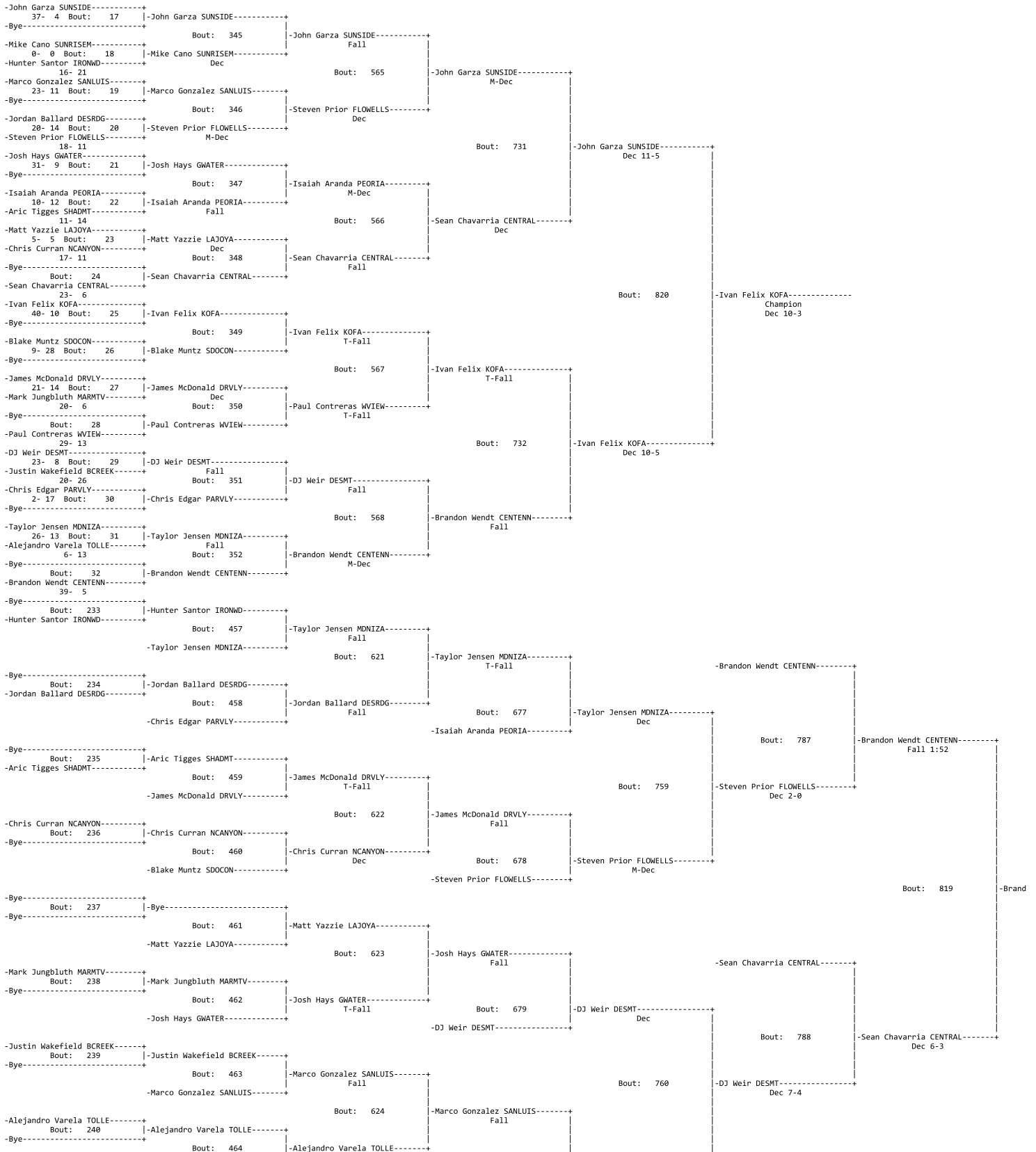

-Mike Cano SUNRISEM-----+ Dec	Bout: 680	-Marco Gonzalez SANLUIS-----+ Dec	
	-Paul Contreras WVIEW-----+ Dec		
		-Steven Prior FLOWELLS-----+ Bout: 818	-DJ Weir DESMT-----+ 5th Place Dec 6-4
- Place Winners -		- Place Winners -	
1st Ivan Felix KOFA	44- 10	5th DJ Weir DESMT	28- 10
2nd John Garza SUNSIDE	40- 5	6th Steven Prior FLOWELLS	22- 14
3rd Brandon Wendt CENTENN	43- 6		
4th Sean Chavarria CENTRAL	26- 8		

Weight: 119

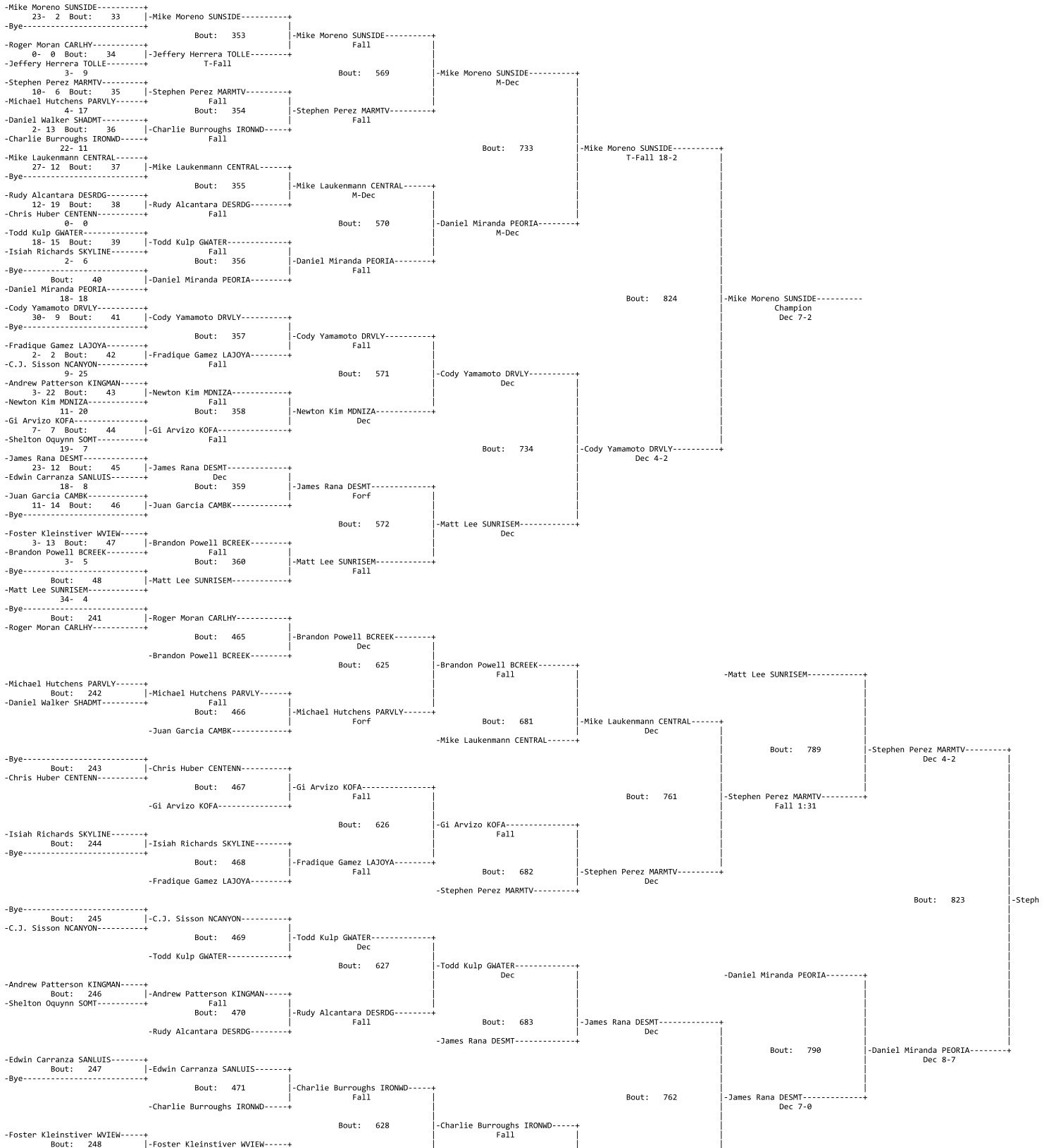

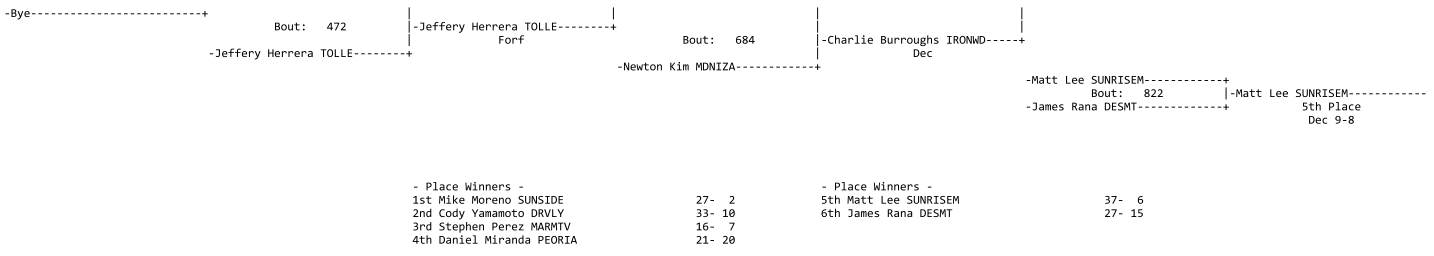

Weight: 125

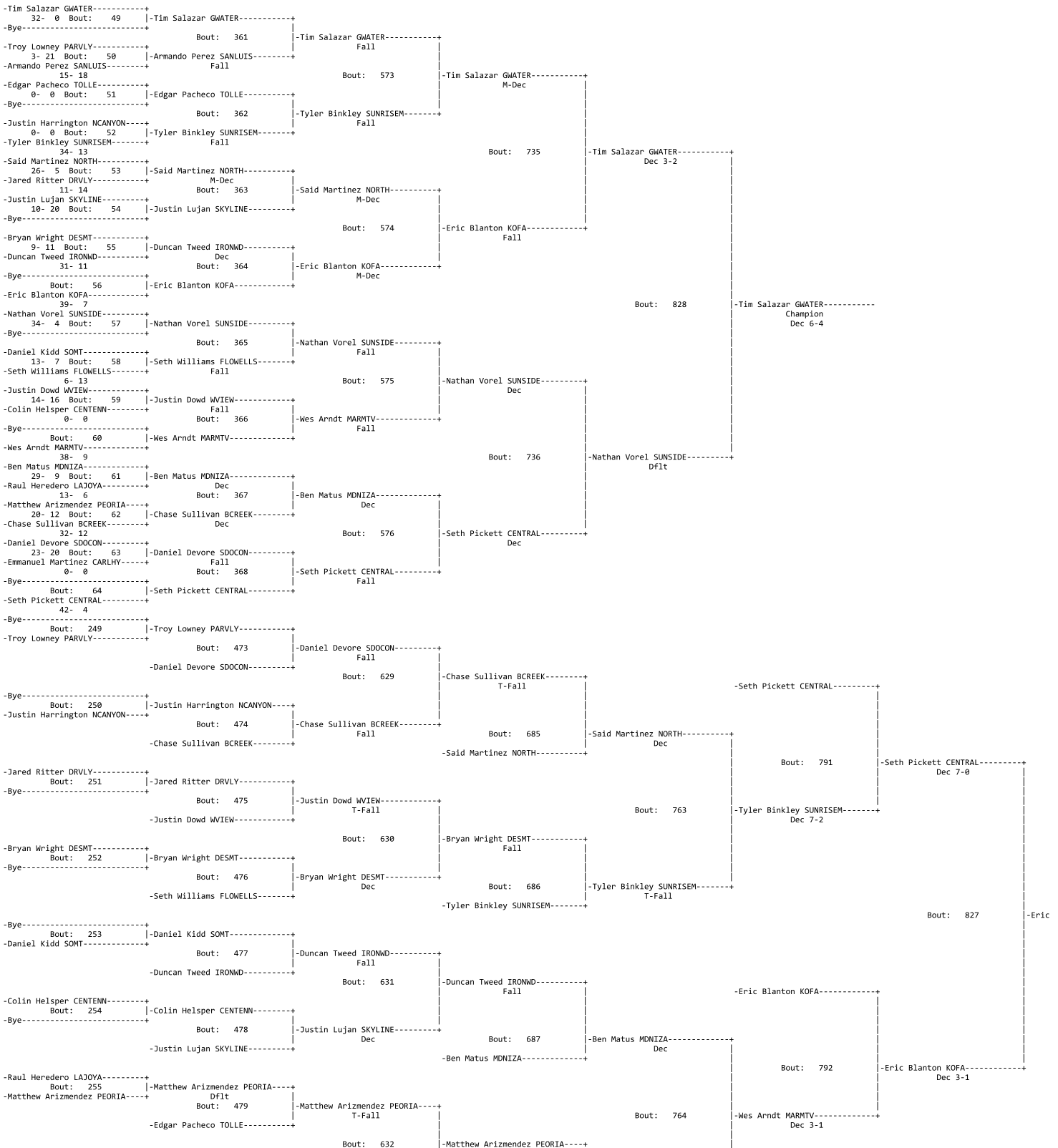

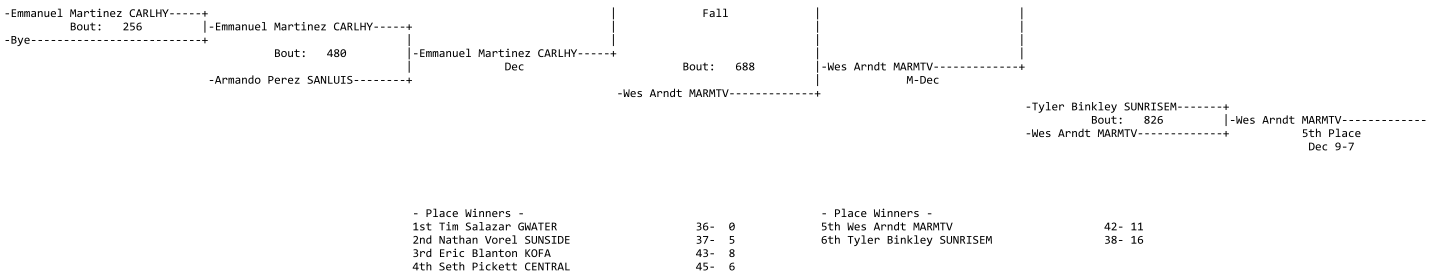

Weight: 130

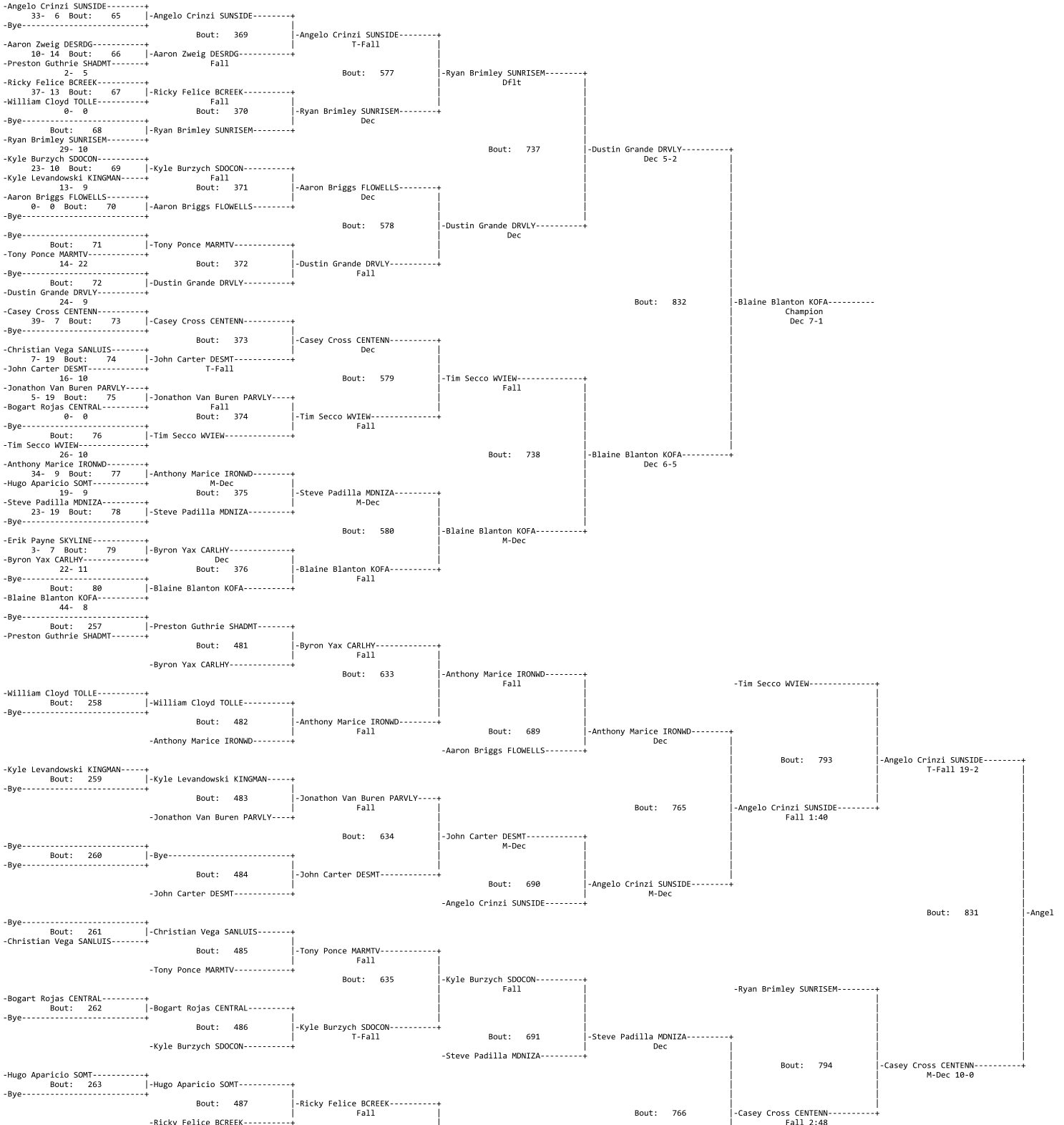

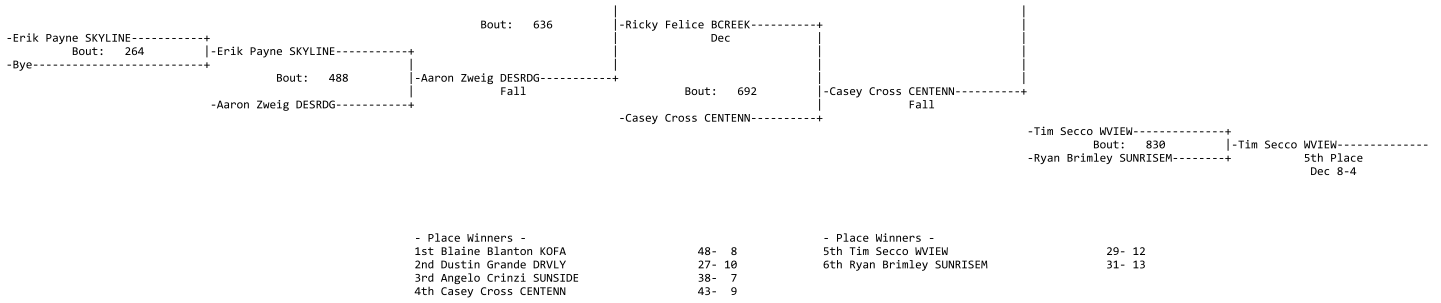

**Weight: 135**

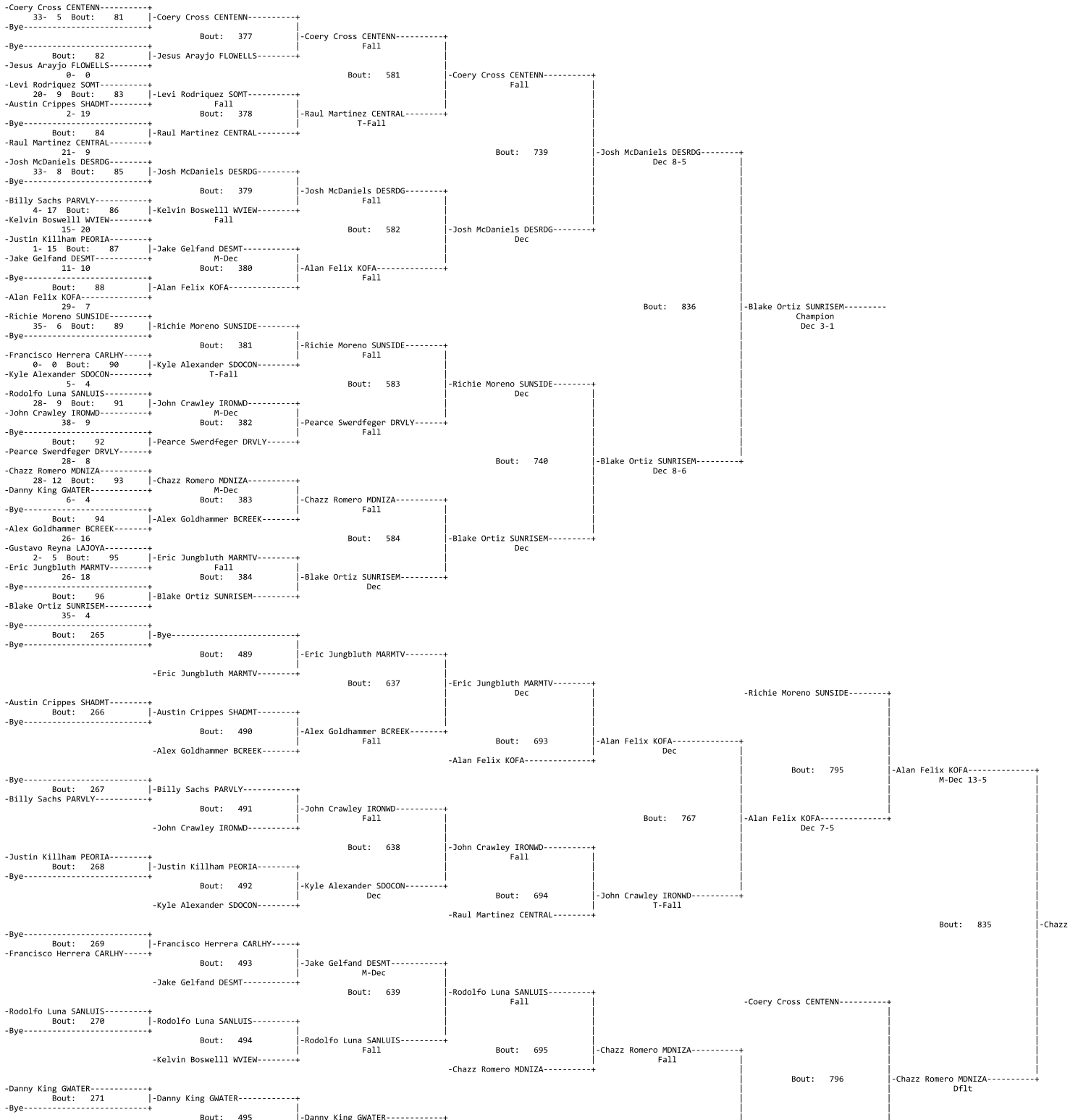

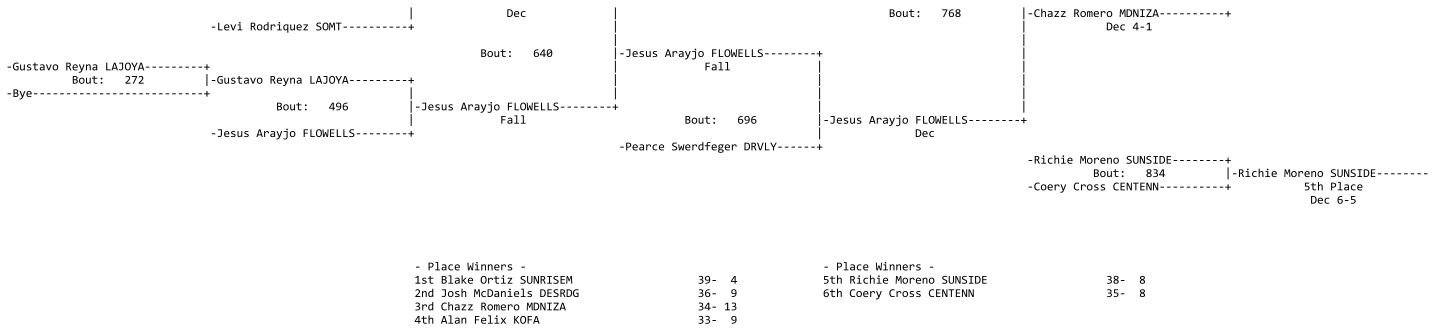

Weight: 140

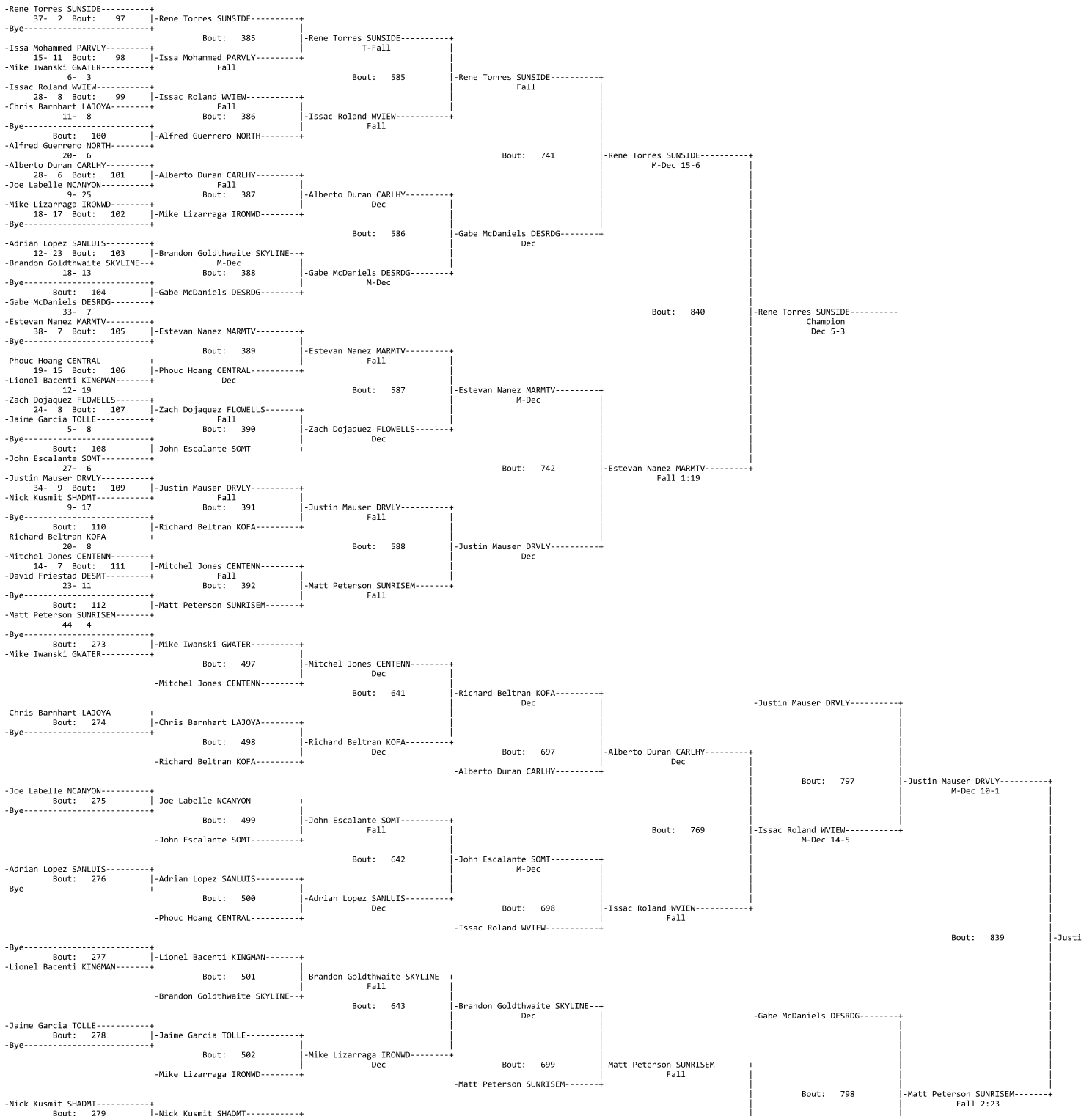

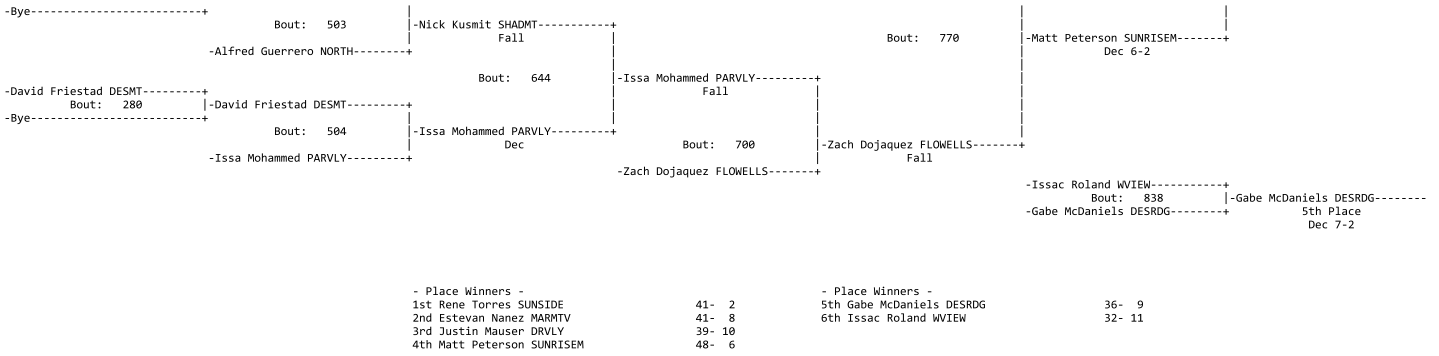

**Weight: 145**





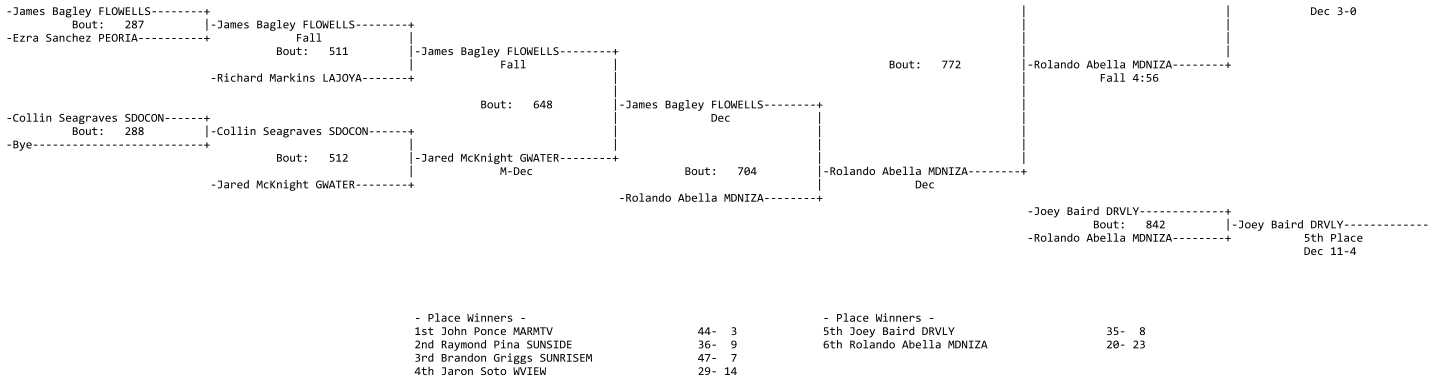

Weight: 152

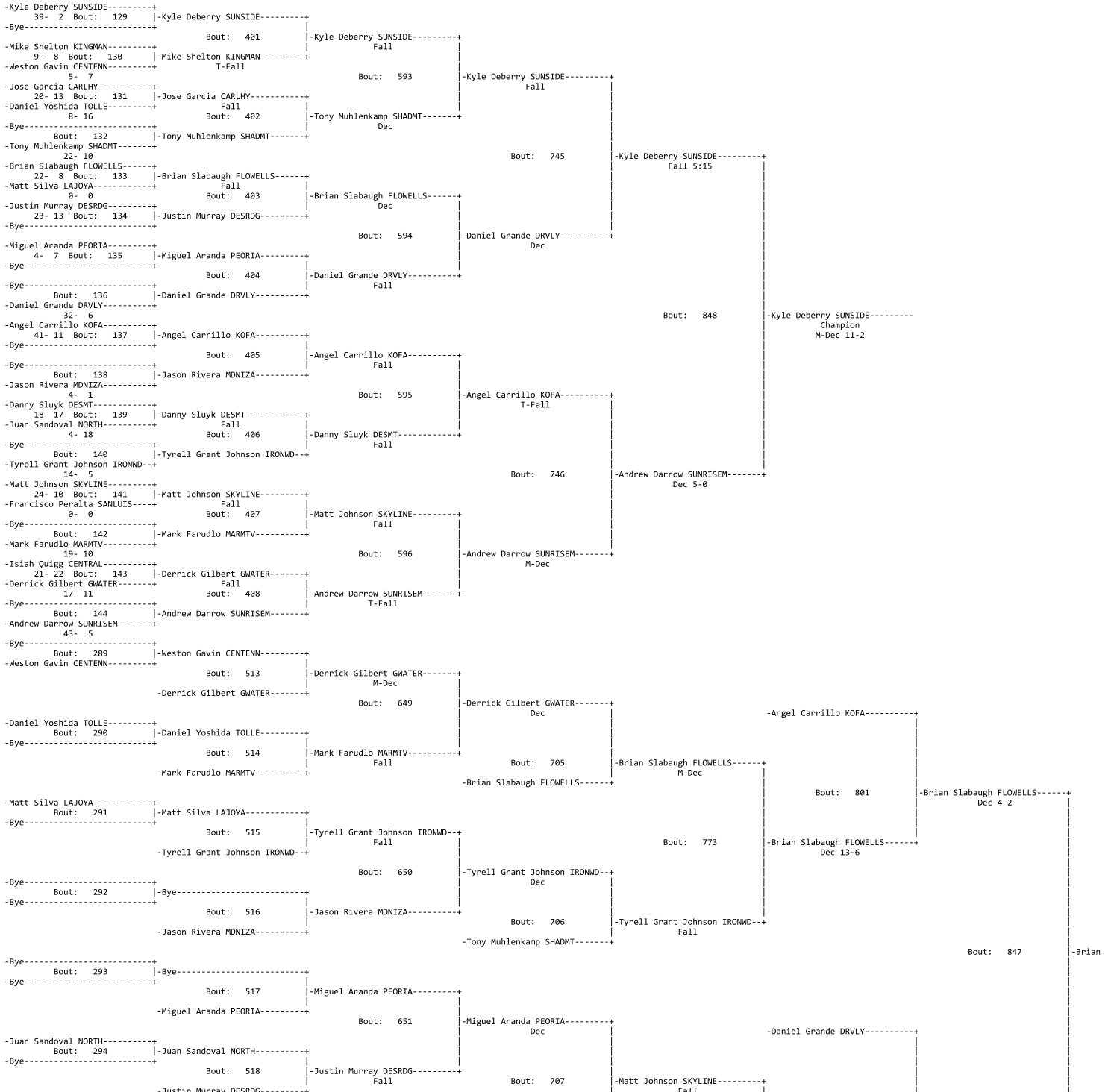

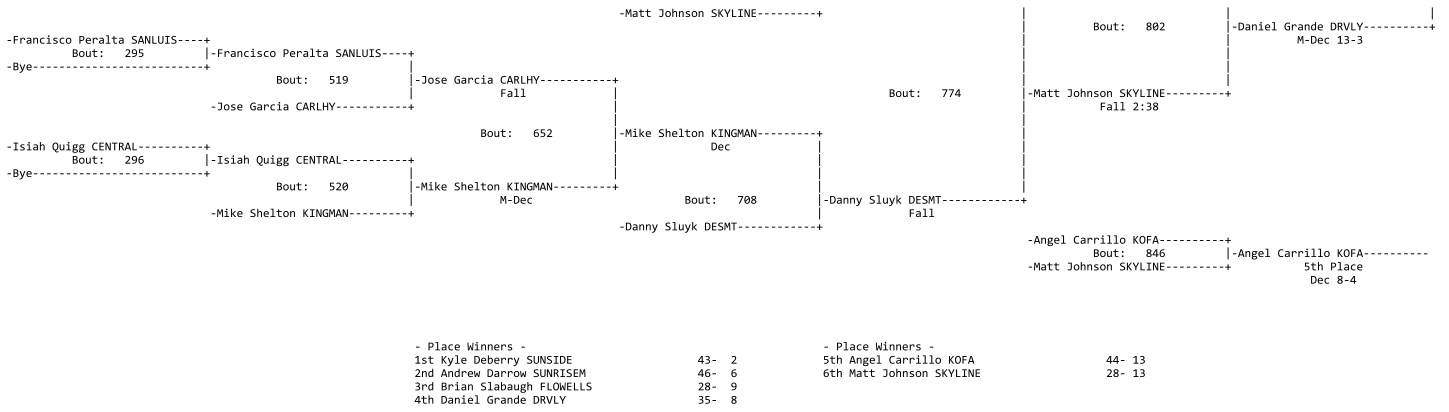

**Weight: 160**

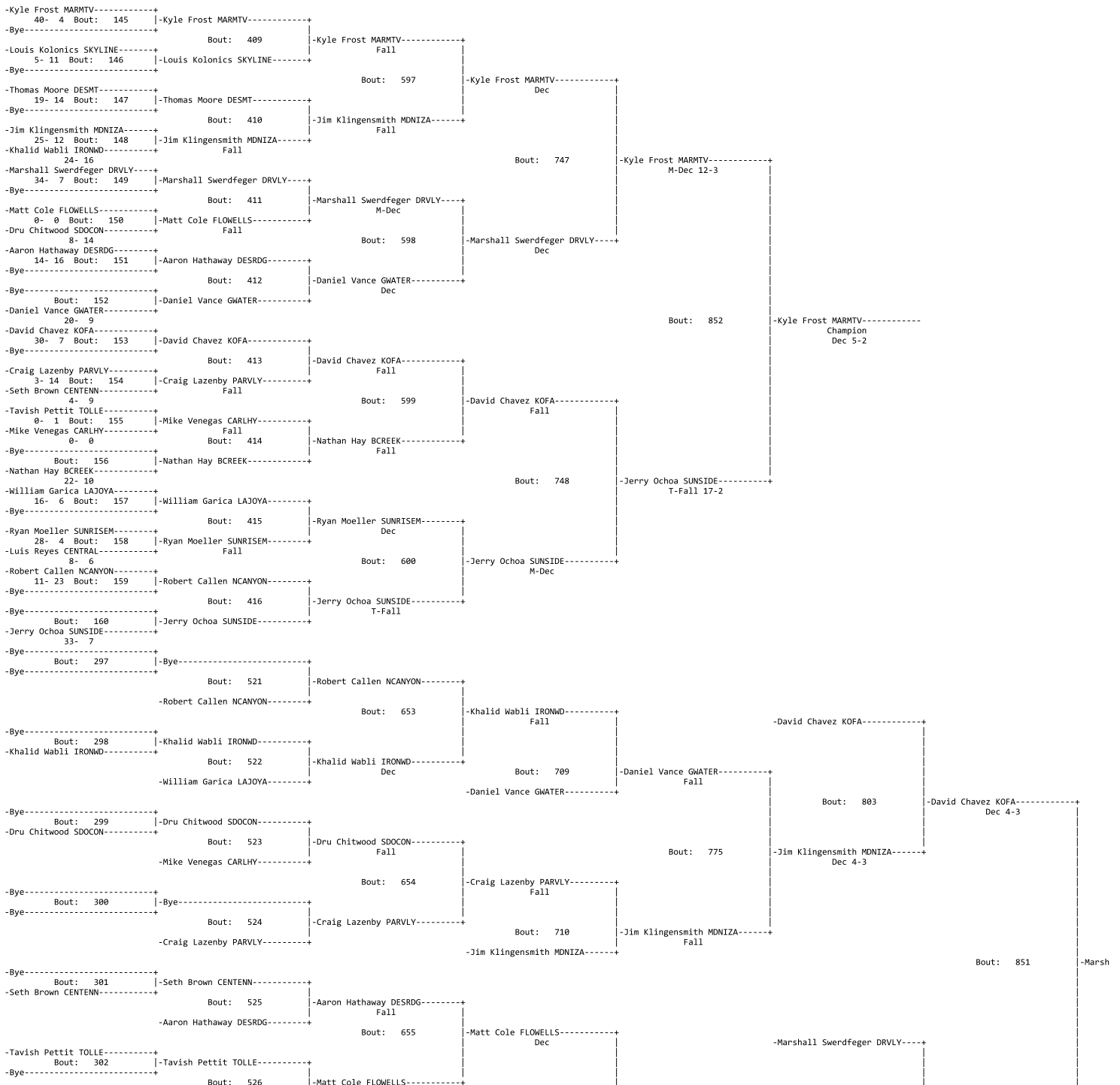

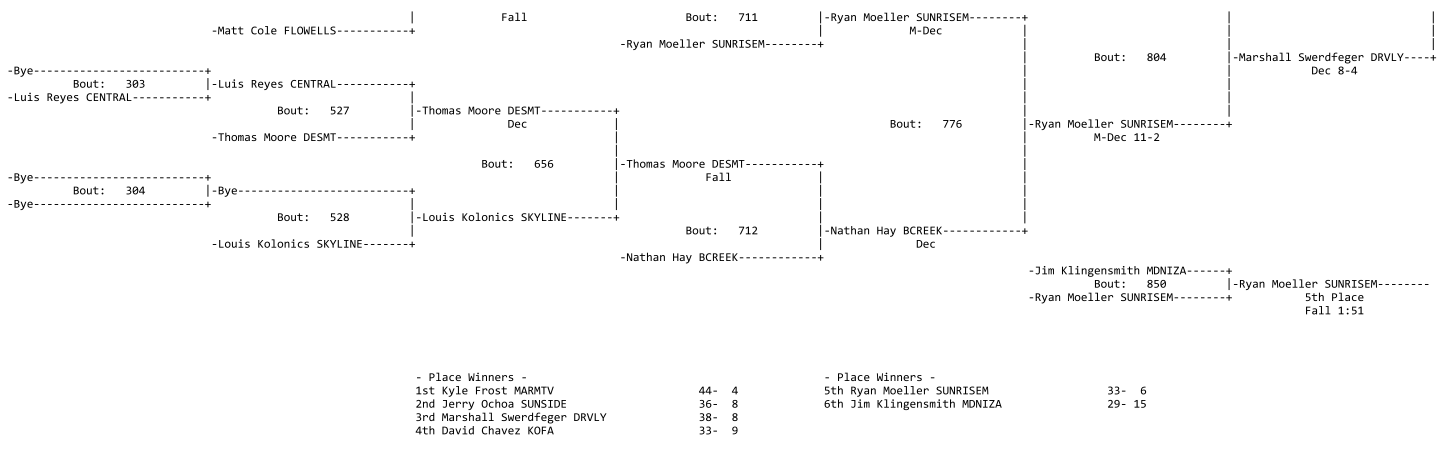

Weight: 171

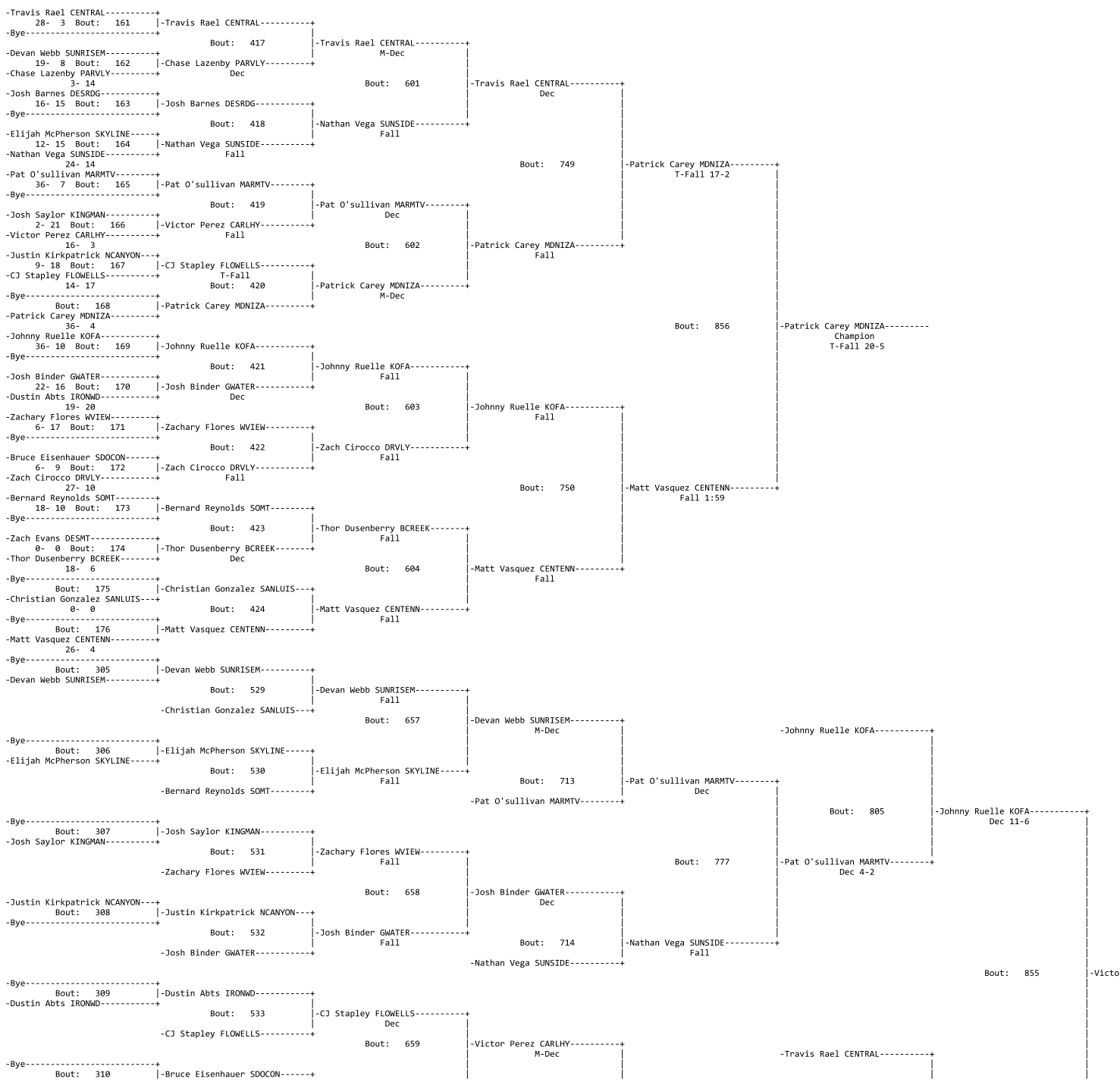

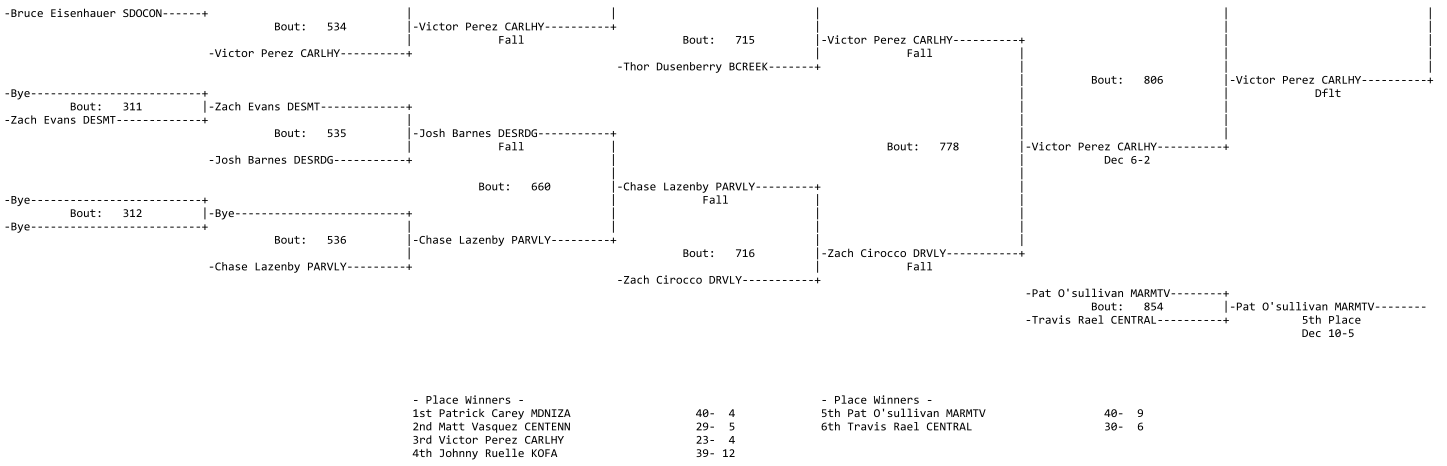

Weight: 189



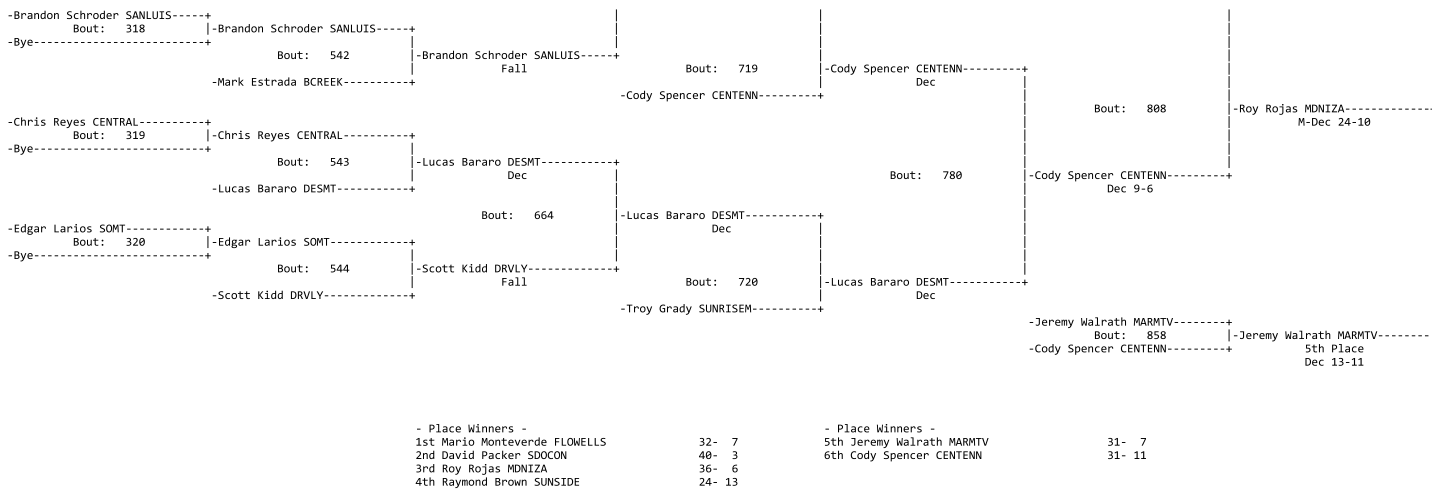

Weight: 215

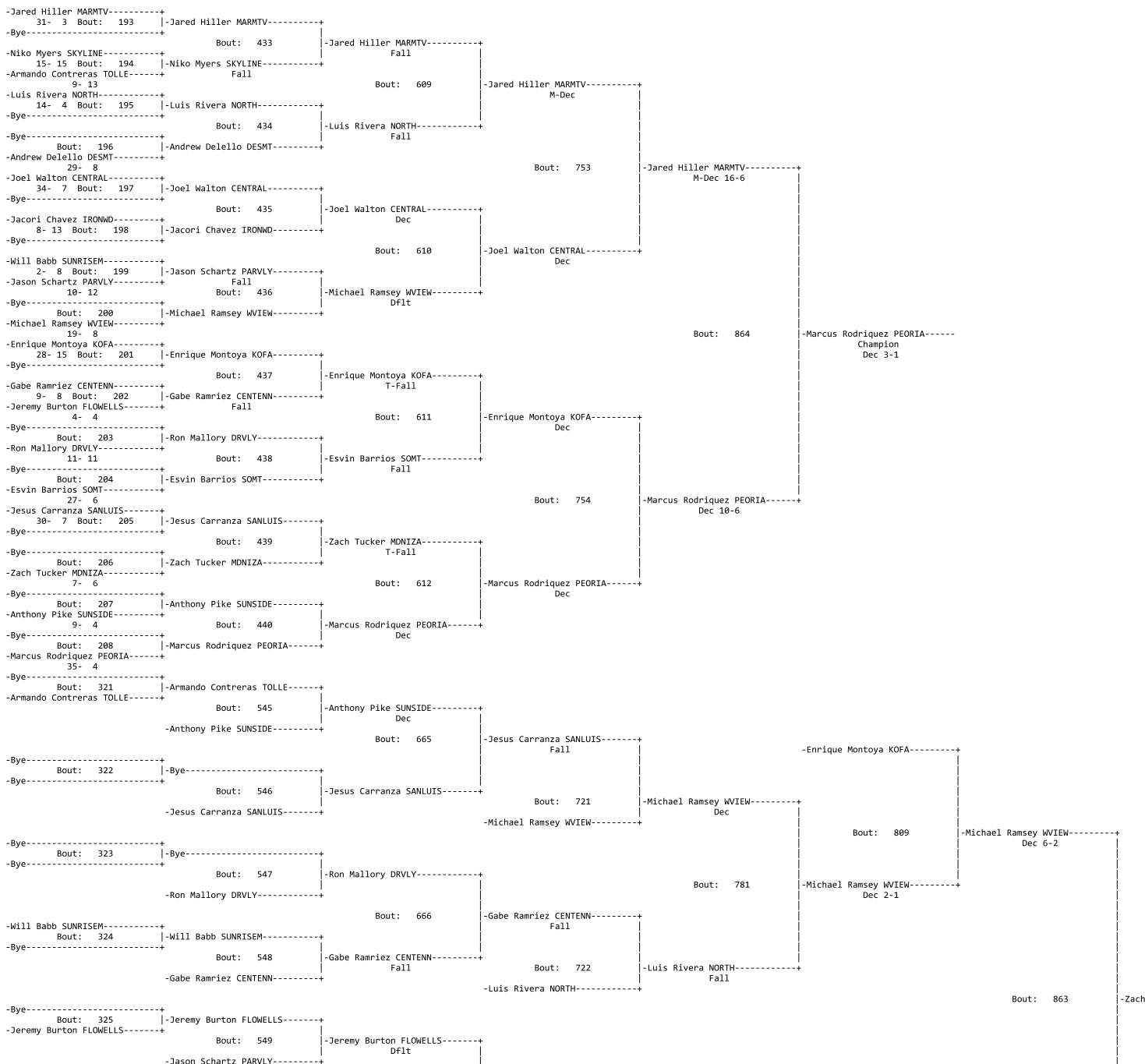

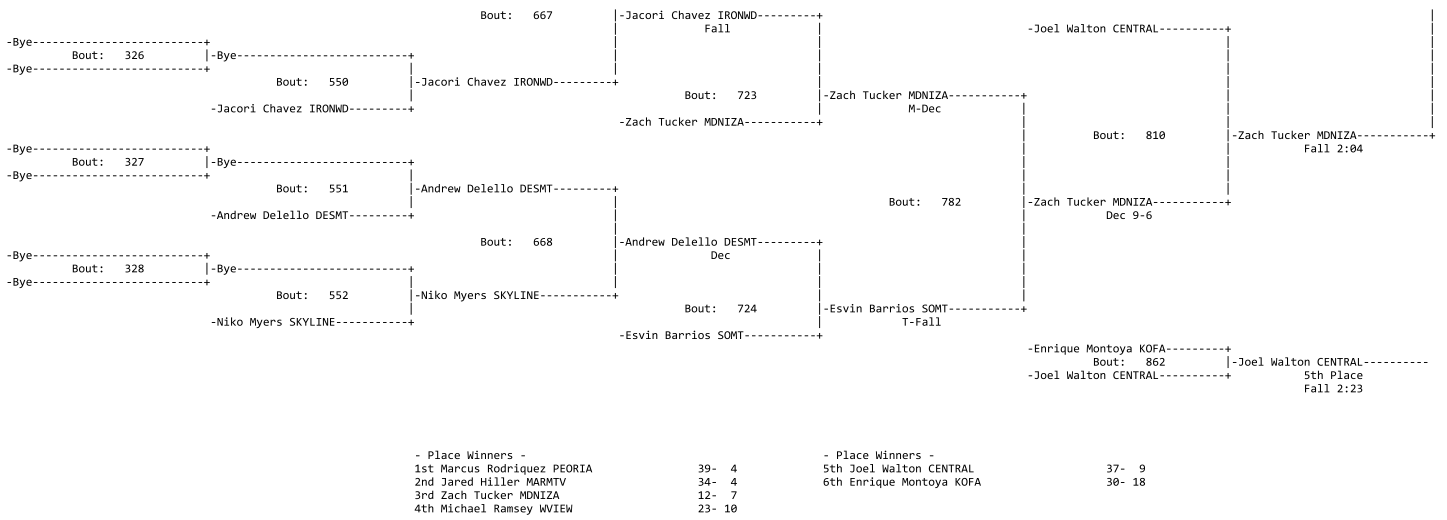

**Weight: 275**

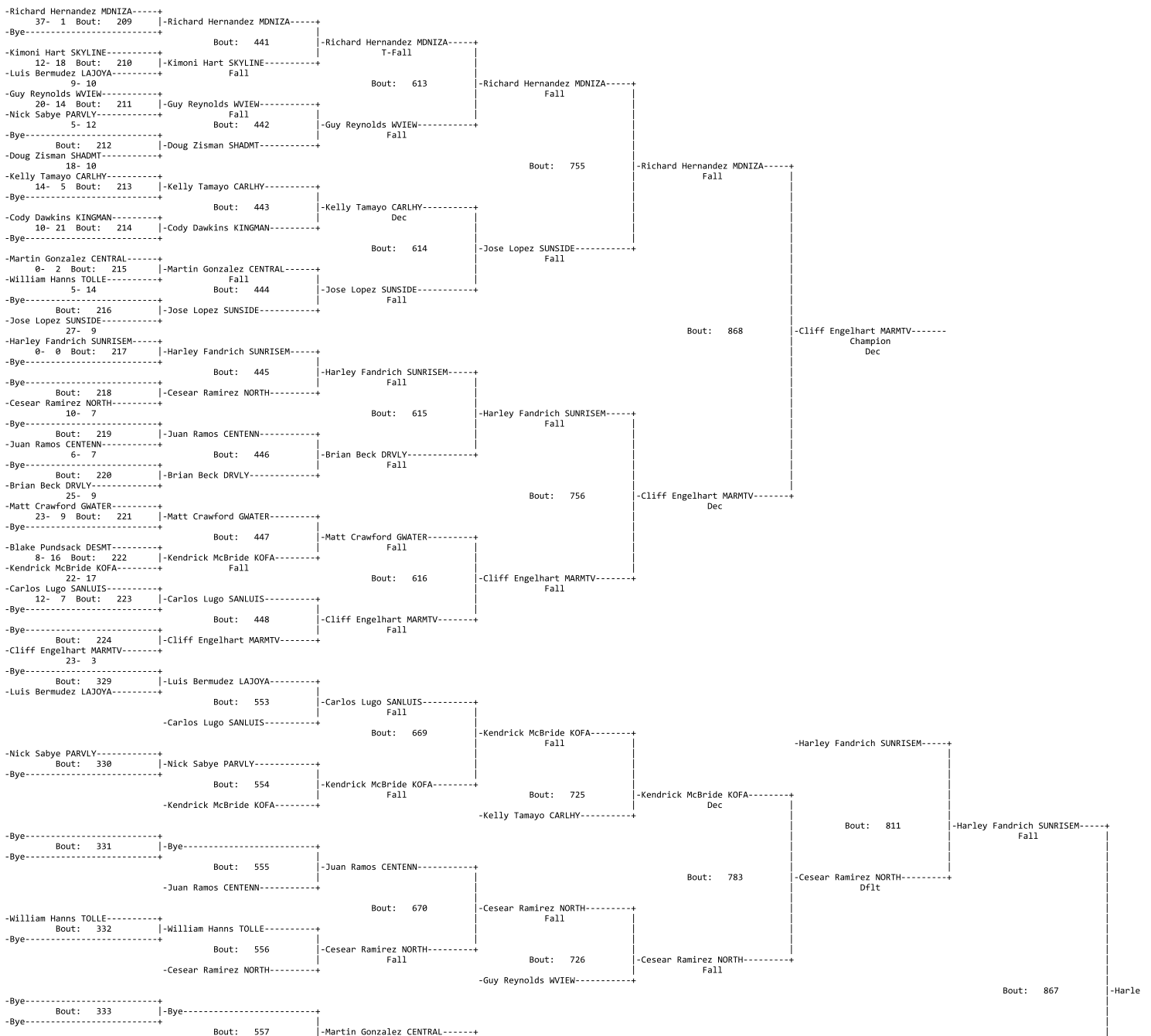

Brackets

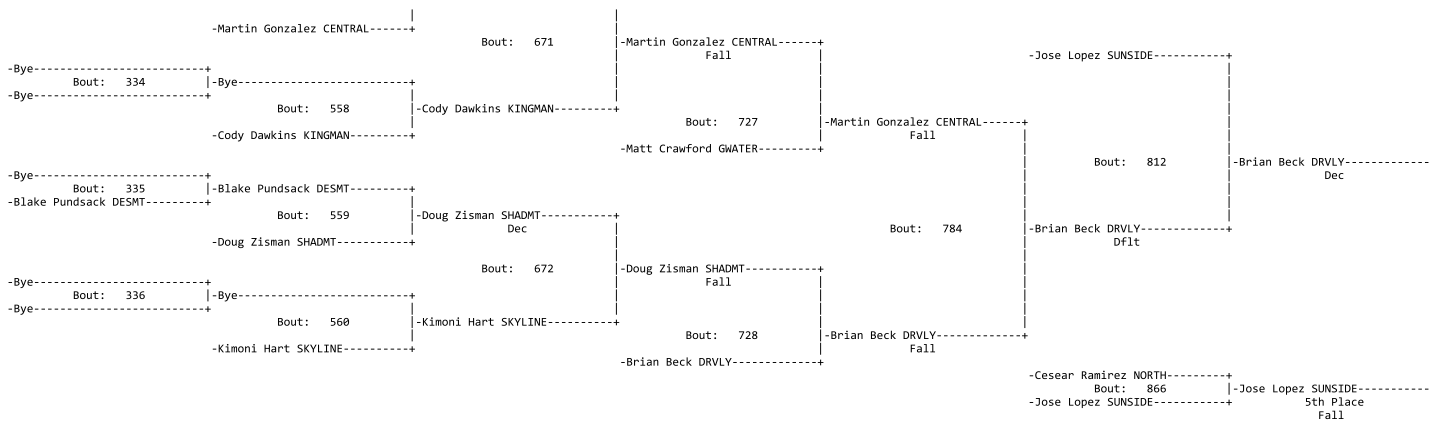

- Place Winners -  
 1st Cliff Engelhart MARMTV  
 2nd Richard Hernandez MDNIZA  
 3rd Harley Friedrich SUNRISEM  
 4th Brian Beck DRVLY

26- 3  
 40- 1  
 4- 1  
 29- 11

- Place Winners -  
 5th Jose Lopez SUNSIDE  
 6th Cesear Ramirez NORTH

30- 11  
 14- 10

Preferred Educational Software

9585 Woodgate Lane  
 Byron IL 61010  
 Phone: (888) 959-2016  
 e-mail: [cotterk@pes-sports.com](mailto:cotterk@pes-sports.com)

(c) 2001 - All rights reserved