

Glendale

State 2005 1A-2A

Team Scores

2/11-2/12

1.	MORENCI	232.00
2.	MARICOPA	165.50
3.	THATCHER	161.50
4.	MOGOLLON	127.00
5.	BISBEE	121.00
6.	SAN MANUEL	120.50
7.	PHOENIX CHRISTIAN	114.50
8.	RED MESA	94.00
9.	JOSEPH CITY	77.00
10.	SAN PASQUAL	74.00
11.	BENSON	64.00
12.	PIMA	58.00
12. (tie)	MANY FARMS	58.00
14.	BOURGADE	52.00
15.	HAYDEN	46.00
16.	VALLEY CHRISTIAN	37.00
17.	SUPERIOR	35.00
18.	CANYON STATE	34.50
19.	ST JOHNS	30.00
20.	SAN CARLOS	28.00
20. (tie)	YUMA CATHOLIC	28.00
22.	ANTELOPE	27.00
23.	ROUGH ROCK	21.00
24.	PUSCH RIDGE	19.00
25.	FLORENCE	17.00
25. (tie)	BABOQUIVRI	17.00
27.	VALLEY SANDERS	11.00
28.	PRECISION	10.50
29.	VALLEY UNION	5.00
30.	SHONTO	3.00
31.	SALT RIVER	0.00
31. (tie)	AZ SCHOOL FOR THE DEAF & BLIND	0.00
33.	PHOENIX DAY SCHOOL	-1.00

Tourney Contact00000
e-mail:**Publisher****Preferred Educational Software**

9585 Woodgate Lane

Byron IL 61010

Phone: (888) 959-2016

e-mail: cotterk@pes-sports.com

© 2001 - All rights reserved

State 2005 1A-2A Glendale 2/11-2/12

Weight: 103

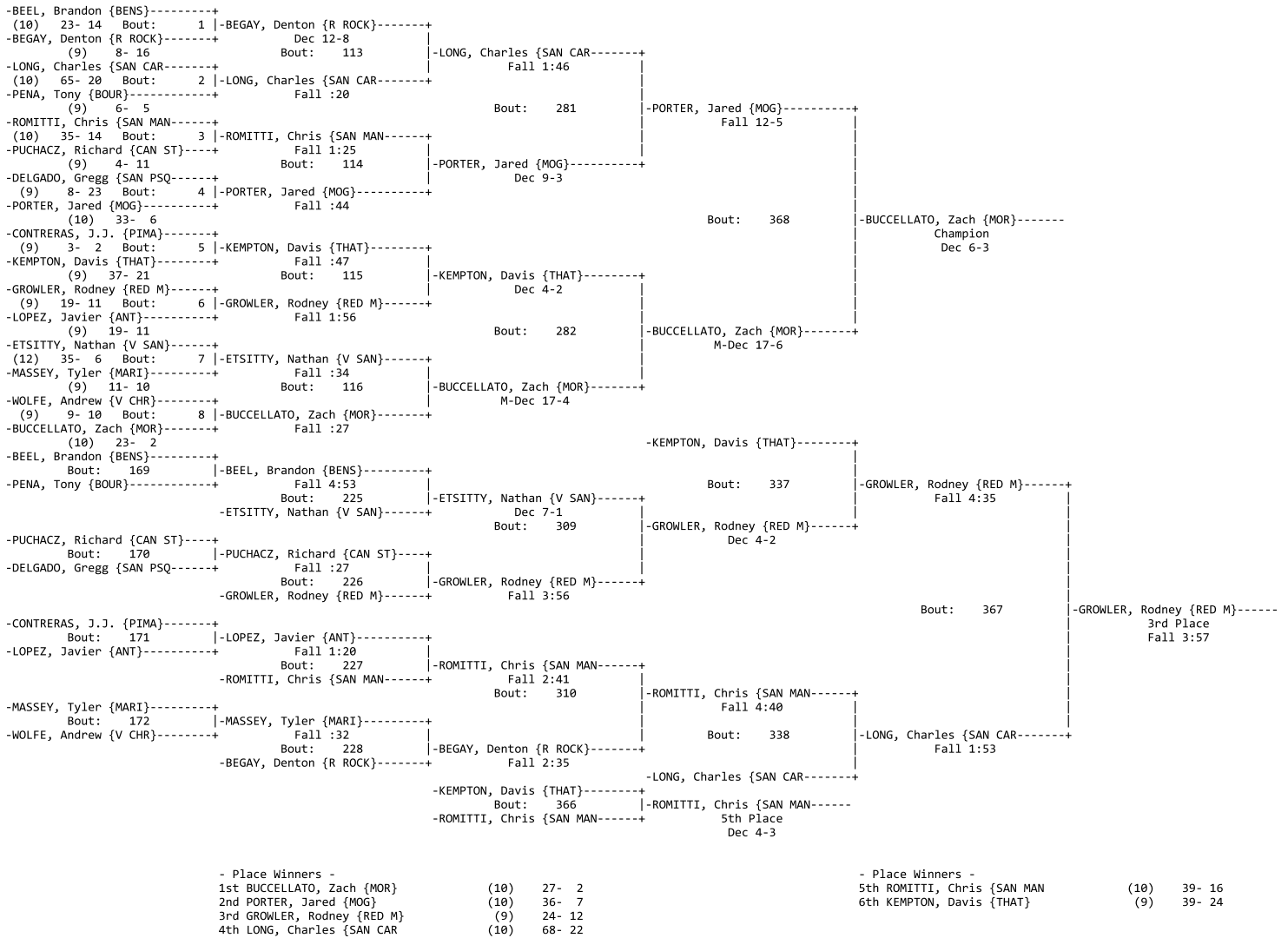

Weight: 112

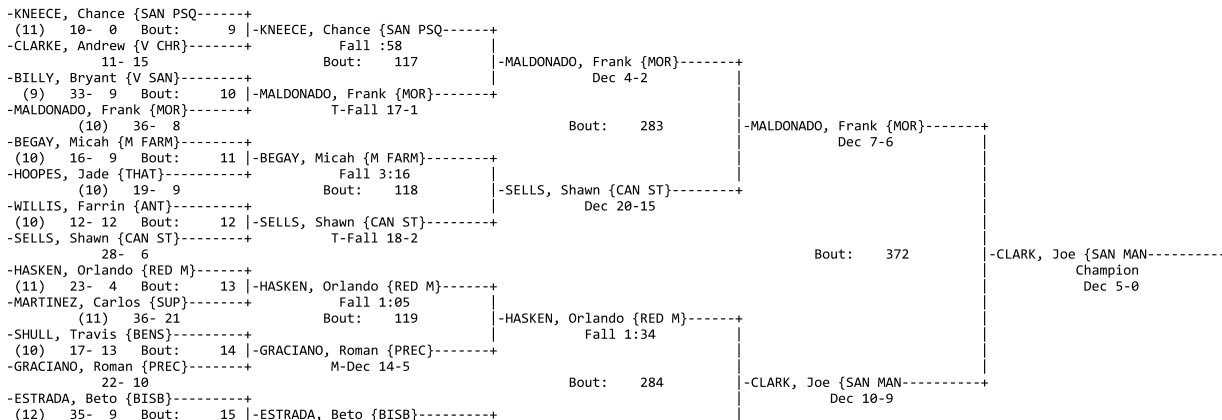

-REYNOLDS, Daniel {PHX CHR}-----+ Fall 2:52
 25- 16 Bout: 120 | -CLARK, Joe {SAN MAN}-----+
 -KIDWELL, Derek {ST JON}-----+ Dec 11-4
 (9) 19- 15 Bout: 16 | -CLARK, Joe {SAN MAN}-----+
 -CLARK, Joe {SAN MAN}-----+ Forf
 (10) 39- 11
 -CLARKE, Andrew {V CHR}-----+
 Bout: 173 | -BILLY, Bryant {V SAN}-----+
 -BILLY, Bryant {V SAN}-----+ Fall :56
 Bout: 229 | -ESTRADA, Beto {BISB}-----+
 -ESTRADA, Beto {BISB}-----+ M-Dec 14-2
 Bout: 311 | -ESTRADA, Beto {BISB}-----+
 -HOOPEES, Jade {THAT}-----+ Bout: 339
 -HOOPEES, Jade {THAT}-----+ Fall 1:21
 -WILLIS, Farrin {ANT}-----+ Dec 12-5
 Bout: 230 | -HOOPEES, Jade {THAT}-----+
 -GRACIANO, Roman {PREC}-----+ Dflt
 -MARTINEZ, Carlos {SUP}-----+ Bout: 371
 Bout: 175 | -SHULL, Travis {BENS}-----+
 -SHULL, Travis {BENS}-----+ Fall :58
 Bout: 231 | -SHULL, Travis {BENS}-----+
 -BEGAY, Micah {M FARM}-----+ Dec 10-8
 Bout: 312 | -KNEECE, Chance {SAN PSQ}-----+
 -REYNOLDS, Daniel {PHX CHR}-----+ Bout: 340
 Bout: 176 | -REYNOLDS, Daniel {PHX CHR}-----+
 -KIDWELL, Derek {ST JON}-----+ Forf
 Bout: 232 | -KNEECE, Chance {SAN PSQ}-----+
 -KNEECE, Chance {SAN PSQ}-----+ Fall 3:44
 -ESTRADA, Beto {BISB}-----+
 Bout: 370 | -SELLS, Shawn {CAN ST}-----+
 -SELLS, Shawn {CAN ST}-----+ Fall 3:56
 - Place Winners -
 1st CLARK, Joe {SAN MAN} (10) 43- 11
 2nd MALDONADO, Frank {MOR} (10) 39- 9
 3rd HASKEN, Orlando {RED M} (11) 27- 5
 4th KNEECE, Chance {SAN PSQ} (11) 14- 2
 - Place Winners -
 5th ESTRADA, Beto {BISB} (12) 39- 11
 6th SELLS, Shawn {CAN ST} 30- 9

Weight: 119

-FIERRO, Adrian {MARI}-----+
 (11) 62- 4 Bout: 17 | -FIERRO, Adrian {MARI}-----+
 -CORDOVA, Jacob {FLOR}-----+ Fall 2:23
 (9) 5- 15 Bout: 121 | -FIERRO, Adrian {MARI}-----+
 -PITRAT, Travis {V CHR}-----+ M-Dec 13-4
 14- 18 Bout: 18 | -MAY, Rocky {JO CITY}-----+
 -MAY, Rocky {JO CITY}-----+ Fall 4:57
 (12) 18- 13 Bout: 285
 -SOLANO, Alfredo {PREC}-----+ | -FIERRO, Adrian {MARI}-----+
 17- 10 Bout: 19 | -SOLANO, Alfredo {PREC}-----+ Dec 13-12
 -CRANDALL, Adam {MOG}-----+ Fall 3:24
 (10) 18- 12 Bout: 122 | -VIECELLI, Tony {MOR}-----+
 -SKOUSEN, Jacob {ANT}-----+ M-Dec 14-2
 (10) 18- 18 Bout: 20 | -VIECELLI, Tony {MOR}-----+
 -VIECELLI, Tony {MOR}-----+ Fall :48
 (11) 48- 6 Bout: 376
 -TSOSIE, Jerald {M FARM}-----+ | -ALVARADO, Andy {PHX CHR}-----+
 (11) 11- 8 Bout: 21 | -TSOSIE, Jerald {M FARM}-----+
 -Bye-----+ M-Dec 15-2
 Bout: 123 | -TSOSIE, Jerald {M FARM}-----+
 -HEISS, Jeremy {BISB}-----+ M-Dec 15-2
 (9) 26- 16 Bout: 22 | -HEISS, Jeremy {BISB}-----+
 -CHRISTENSEN, Trent {THAT}-----+ Fall 1:04
 (9) 25- 10 Bout: 286
 -LOWE, Brian {SAN PSQ}-----+ | -ALVARADO, Andy {PHX CHR}-----+
 (11) 26- 4 Bout: 23 | -LOWE, Brian {SAN PSQ}-----+ M-Dec 14-1
 -MARTINEZ, Daniel {SAN MAN}-----+ Fall 4:39
 (10) 14- 9 Bout: 124 | -ALVARADO, Andy {PHX CHR}-----+
 -SIX, Troy {ST JON}-----+ Dec 12-10
 (9) 17- 8 Bout: 24 | -ALVARADO, Andy {PHX CHR}-----+
 -ALVARADO, Andy {PHX CHR}-----+ Fall 3:20
 28- 5 Bout: 341
 -CORDOVA, Jacob {FLOR}-----+ | -TSOSIE, Jerald {M FARM}-----+
 Bout: 177 | -PITRAT, Travis {V CHR}-----+ Bout: 341
 -PITRAT, Travis {V CHR}-----+ Fall 2:06
 Bout: 233 | -LOWE, Brian {SAN PSQ}-----+
 -LOWE, Brian {SAN PSQ}-----+ Fall 3:12
 Bout: 313 | -LOWE, Brian {SAN PSQ}-----+
 -CRANDALL, Adam {MOG}-----+ Fall 4:58
 Bout: 178 | -CRANDALL, Adam {MOG}-----+
 -SKOUSEN, Jacob {ANT}-----+ Fall :42
 Bout: 234 | -CRANDALL, Adam {MOG}-----+
 -HEISS, Jeremy {BISB}-----+ T-Fall 18-3
 Bout: 375
 -Bye-----+ | -VIECELLI, Tony {MOR}-----+
 Bout: 179 | -CHRISTENSEN, Trent {THAT}-----+
 -CHRISTENSEN, Trent {THAT}-----+ Bout: 235
 -SOLANO, Alfredo {PREC}-----+
 Bout: 314
 -MARTINEZ, Daniel {SAN MAN}-----+ | -MAY, Rocky {JO CITY}-----+
 Bout: 180 | -MARTINEZ, Daniel {SAN MAN}-----+ Dec 8-1
 -SIX, Troy {ST JON}-----+ Fall 4:56
 Bout: 236 | -MAY, Rocky {JO CITY}-----+
 -MAY, Rocky {JO CITY}-----+ Fall 3:59
 Bout: 342
 -VIECELLI, Tony {MOR}-----+
 -TSOSIE, Jerald {M FARM}-----+
 Bout: 374
 -MAY, Rocky {JO CITY}-----+
 -MAY, Rocky {JO CITY}-----+ 5th Place
 Dec 15-10
 - Place Winners -
 1st ALVARADO, Andy {PHX CHR} 32- 5
 2nd FIERRO, Adrian {MARI} (11) 65- 5
 3rd VIECELLI, Tony {MOR} (11) 52- 7
 4th LOWE, Brian {SAN PSQ} (11) 30- 6
 - Place Winners -
 5th MAY, Rocky {JO CITY} (12) 22- 15
 6th TSOSIE, Jerald {M FARM} (11) 12- 11

Weight: 125

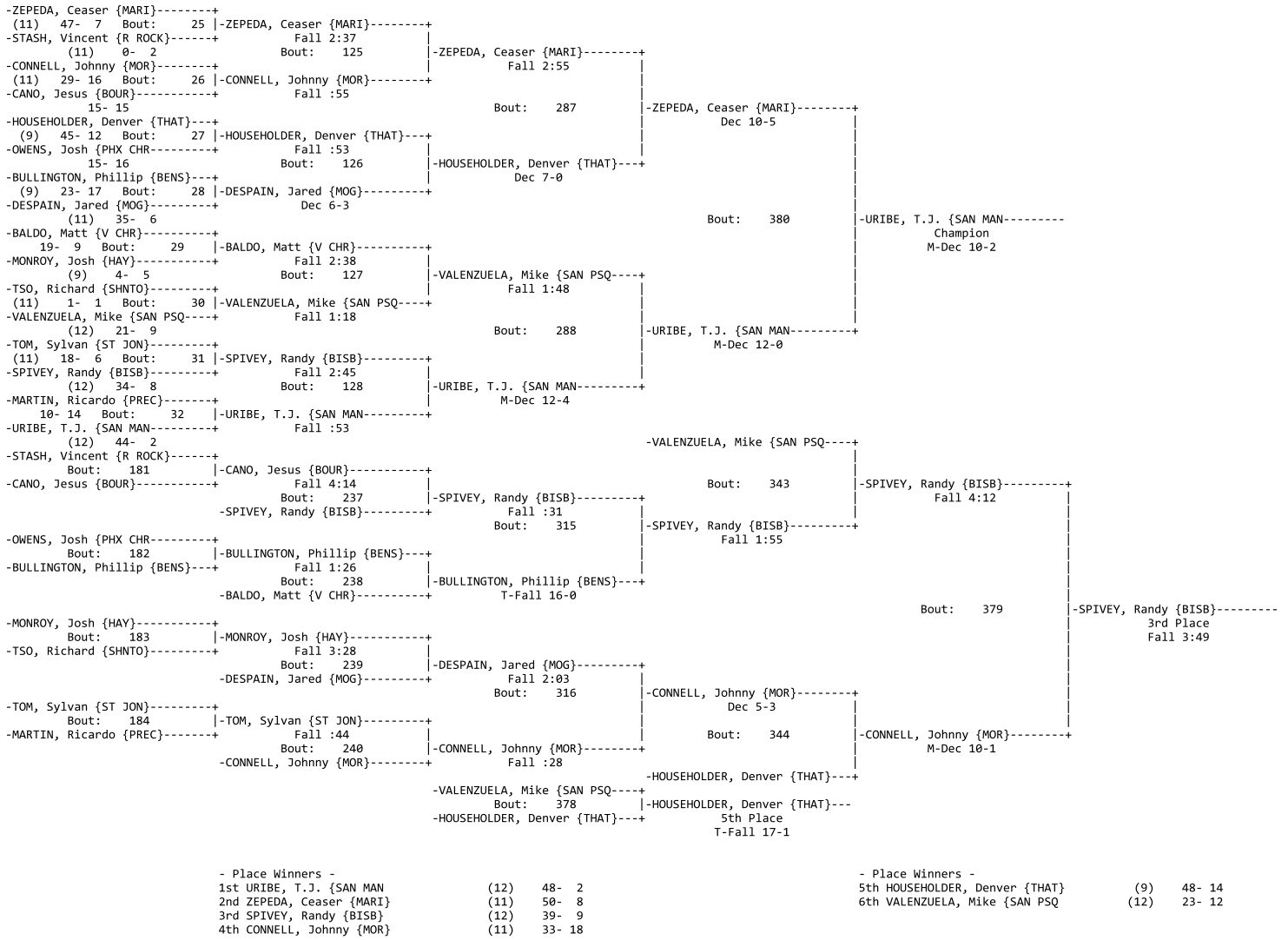

Weight: 130

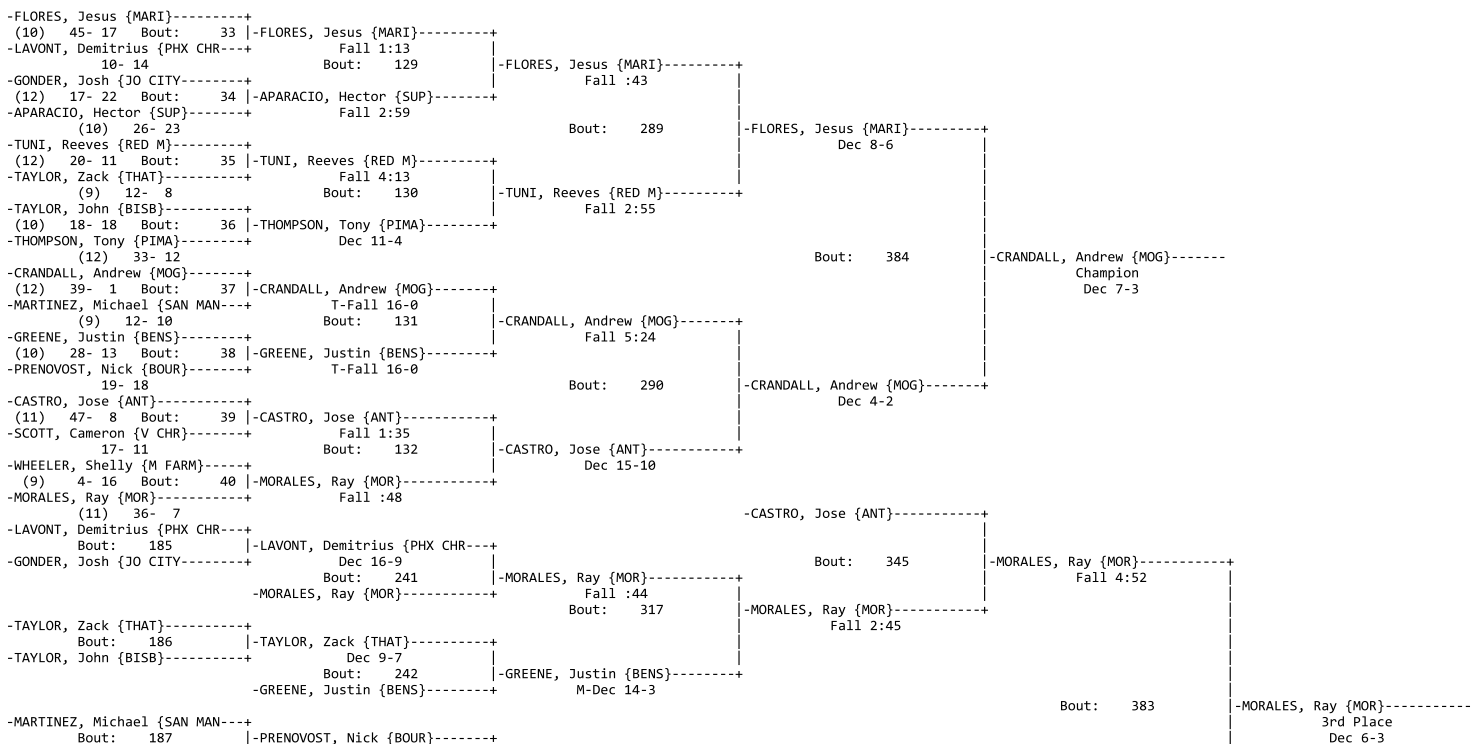

-PRENOVOST, Nick {BOUR}-----+ Dec 6-4 Bout: 243	-THOMPSON, Tony {PIMA}-----+ Dflt Bout: 318	-PRENOVOST, Nick {BOUR}-----+ Dec 6-3	
-SCOTT, Cameron {V CHR}-----+ Bout: 188	-WHEELER, Shelly {M FARM}-----+ Fall 2:51 Bout: 244	-SCOTT, Cameron {V CHR}-----+ Dec 9-8	-TUNI, Reeves {RED M}-----+ Fall 1:57
-APARACIO, Hector {SUP}-----+ Dec 9-8	-CASTRO, Jose {ANT}-----+ Bout: 382	-PRENOVOST, Nick {BOUR}-----+ 5th Place Fall 1:43	

- Place Winners -		- Place Winners -	
1st CRANDALL, Andrew {MOG}	(12) 43- 1	5th CASTRO, Jose {ANT}	(11) 50- 10
2nd FLORES, Jesus {MARI}	(10) 48- 18	6th PRENOVOST, Nick {BOUR}	22- 21
3rd MORALES, Ray {MOR}	(11) 41- 8		
4th TUNI, Reeves {RED M}	(12) 23- 13		

Weight: 135

-FREGOSO, Michael {BISB}-----+ (12) 39- 3 Bout: 41	-MAGALLANEZ, Kenny {SUP}-----+ (9) 27- 24 Bout: 133	-FREGOSO, Michael {BISB}-----+ M-Dec 12-3	
-CUMMINS, Jacob {PHX CHR}-----+ 28- 15 Bout: 42	-BARNET, Danny {MOG}-----+ (11) 19- 15	-CUMMINS, Jacob {PHX CHR}-----+ M-Dec 13-4	
-BEUS, Ty {PIMA}-----+ (11) 32- 16 Bout: 43	-BEGAY, Shoshannon {SHNTD}-----+ (11) 11- 8	-BEUS, Ty {PIMA}-----+ T-Fall 16-1 Bout: 134	
-THOMPSON, Travis {YUMA C}-----+ (10) 24- 14 Bout: 44	-ROSS, Scott {MOR}-----+ (12) 36- 12	-ROSS, Scott {MOR}-----+ Fall :43	
-HERRICK, Drew {ST JON}-----+ (9) 14- 7 Bout: 45	-GUERRERO, Alex {BOUR}-----+ 11- 16	-HERRICK, Drew {ST JON}-----+ Fall 1:54 Bout: 135	
-BERNAL, Jaymes {BENS}-----+ (10) 28- 18 Bout: 46	-ROMERO, Bernie {THAT}-----+ (10) 26- 3	-ROMERO, Bernie {THAT}-----+ M-Dec 18-6	
-SCOFIELD, Boyd {MARI}-----+ (11) 61- 7 Bout: 47	-SALAZAR, Roman {SAN MAN}-----+ (11) 24- 12	-SCOFIELD, Boyd {MARI}-----+ T-Fall 16-1 Bout: 136	
-HENSLLEY, Stewart {JO CITY}-----+ (9) 8- 20 Bout: 48	-SMITH, Shawn {V CHR}-----+ 19- 2	-SMITH, Shawn {V CHR}-----+ Fall :23	
-MAGALLANEZ, Kenny {SUP}-----+ Bout: 189	-BARNET, Danny {MOG}-----+ Dec 9-4	-MAGALLANEZ, Kenny {SUP}-----+ Dec 9-4 Bout: 245	
-BEGAY, Shoshannon {SHNTD}-----+ Bout: 190	-THOMPSON, Travis {YUMA C}-----+ Fall 4:29	-BEGAY, Shoshannon {SHNTD}-----+ Fall 4:29 Bout: 246	
-GUERRERO, Alex {BOUR}-----+ Bout: 191	-BERNAL, Jaymes {BENS}-----+ T-Fall 18-2	-HERRICK, Drew {ST JON}-----+ Dec 6-4	
-BERNAL, Jaymes {BENS}-----+ Bout: 247	-BEUS, Ty {PIMA}-----+ Dec 8-6	-SCOFIELD, Boyd {MARI}-----+ Fall :20 Bout: 319	
-SALAZAR, Roman {SAN MAN}-----+ Bout: 192	-HENSLLEY, Stewart {JO CITY}-----+ Fall 1:48	-SCOFIELD, Boyd {MARI}-----+ Fall 2:28	
-CUMMINS, Jacob {PHX CHR}-----+ M-Dec 11-3	-SALAZAR, Roman {SAN MAN}-----+ Dec 13-10	-SCOFIELD, Boyd {MARI}-----+ Fall 2:28	
-SMITH, Shawn {V CHR}-----+ Bout: 386	-SALAZAR, Roman {SAN MAN}-----+ Bout: 348	-SCOFIELD, Boyd {MARI}-----+ Dec 9-3	
-SALAZAR, Roman {SAN MAN}-----+ 5th Place Dec 8-2	-ROSS, Scott {MOR}-----+ M-Dec 13-5	-SCOFIELD, Boyd {MARI}-----+ 3rd Place Dec 7-3	
	-SMITH, Shawn {V CHR}-----+ Bout: 347		
	-SMITH, Shawn {V CHR}-----+ Bout: 387		

- Place Winners -		- Place Winners -	
1st FREGOSO, Michael {BISB}	(12) 43- 3	5th SMITH, Shawn {V CHR}	22- 4
2nd ROMERO, Bernie {THAT}	(10) 29- 4	6th SALAZAR, Roman {SAN MAN}	(11) 27- 15
3rd SCOFIELD, Boyd {MARI}	(11) 66- 8		
4th ROSS, Scott {MOR}	(12) 39- 14		

Weight: 140

-VILLA, Carlos {MARI}-----+ (11) 65- 0 Bout: 49	-VAUGHN, Logan {JO CITY}-----+ (11) 12- 14 Bout: 137	-VILLA, Carlos {MARI}-----+ Fall 1:00	
-RAY, Dustin {THAT}-----+ (12) 19- 11 Bout: 50	-TORRES, Erick {BOUR}-----+ 24- 8	-RAY, Dustin {THAT}-----+ Fall :44	
-PINA, Frankie {HAY}-----+ (12) 22- 11 Bout: 51	-SITEK, Alex {V CHR}-----+ 18- 11	-PINA, Frankie {HAY}-----+ Fall 4:34 Bout: 138	
-Bye-----+ Bout: 52	-BENTLY, David {MOG}-----+ (11) 32- 8	-BENTLY, David {MOG}-----+ Dec 9-8	
-FRENCH, Jason {PIMA}-----+ (12) 42- 4 Bout: 53		-VILLA, Carlos {MARI}-----+ M-Dec 16-5	
		-VILLA, Carlos {MARI}-----+ Champion M-Dec 10-2	

-ADAMI, Andrew {SAN MAN}-----+ T-Fall 17-1
 (10) 19- 22 Bout: 139
 -LEE, Matt {V SAN}-----+
 (9) 32- 14 Bout: 54 | -HERNANDEZ, Freddie {BENS}-----+
 -HERNANDEZ, Freddie {BENS}-----+ T-Fall 18-0
 (11) 30- 8 Bout: 294
 -HOT, Derwin {RED M}-----+ | -FRENCH, Jason {PIMA}-----+
 (12) 22- 11 Bout: 55 | -HOT, Derwin {RED M}-----+
 -JIMINEZ, Anthony {BISB}-----+ | Dec 15-13
 (11) 30- 16 Bout: 140 | -WYATT, Roylee {MOR}-----+
 -MOORE, Andrew {PHX CHR}-----+ | -WYATT, Roylee {MOR}-----+
 28- 20 Bout: 56 | -WYATT, Roylee {MOR}-----+
 -WYATT, Roylee {MOR}-----+ | M-Dec 10-2
 (12) 37- 13 Bout: 193 | -TORRES, Erick {BOUR}-----+
 -VAUGHN, Logan {JO CITY}-----+ | -TORRES, Erick {BOUR}-----+
 Bout: 193 | Fall 1:46
 -TORRES, Erick {BOUR}-----+ | Bout: 249
 | -HOT, Derwin {RED M}-----+
 | -HOT, Derwin {RED M}-----+
 | Dq 4:40
 | Bout: 321
 -SITEK, Alex {V CHR}-----+ | -SITEK, Alex {V CHR}-----+
 Bout: 194 | -SITEK, Alex {V CHR}-----+
 -Bye-----+ | Bout: 250
 | -HERNANDEZ, Freddie {BENS}-----+
 | -HERNANDEZ, Freddie {BENS}-----+
 | M-Dec 9-0
 | Bout: 391
 -ADAMI, Andrew {SAN MAN}-----+ | -ADAMI, Andrew {SAN MAN}-----+
 Bout: 195 | Dec 8-5
 -LEE, Matt {V SAN}-----+ | Bout: 251
 | -PINA, Frankie {HAY}-----+
 | -PINA, Frankie {HAY}-----+
 | Dec 8-2
 | Bout: 322
 -JIMINEZ, Anthony {BISB}-----+ | -JIMINEZ, Anthony {BISB}-----+
 Bout: 196 | Fall 3:26
 -MOORE, Andrew {PHX CHR}-----+ | Bout: 252
 | -RAY, Dustin {THAT}-----+
 | -RAY, Dustin {THAT}-----+
 | Fall 1:30
 | -WYATT, Roylee {MOR}-----+
 | Bout: 390
 | -BENTLY, David {MOG}-----+
 | -BENTLY, David {MOG}-----+
 | 5th Place
 | Dec 4-1
 - Place Winners -
 1st VILLA, Carlos {MARI} (11) 69- 0
 2nd FRENCH, Jason {PIMA} (12) 45- 5
 3rd HERNANDEZ, Freddie {BENS} (11) 35- 9
 4th PINA, Frankie {HAY} (12) 26- 13
 - Place Winners -
 5th BENTLY, David {MOG} (11) 34- 10
 6th WYATT, Roylee {MOR} (12) 39- 16
 -HERNANDEZ, Freddie {BENS}-----+
 Fall :36
 -HERNANDEZ, Freddie {BENS}-----+
 Fall
 -HERNANDEZ, Freddie {BENS}-----+
 M-Dec 11-2
 Bout: 350
 -PINA, Frankie {HAY}-----+
 Dec 3-1
 -BENTLY, David {MOG}-----+
 -BENTLY, David {MOG}-----+
 Dec 4-1
 -HERNANDEZ, Freddie {BENS}-----+
 3rd Place
 Dec 6-2

Weight: 145

-FENSEL, Porter {MARI}-----+
 (11) 59- 6 Bout: 57 | -FENSEL, Porter {MARI}-----+
 -HERNANDEZ, Rick {BOUR}-----+ | Fall 1:51
 6- 16 Bout: 141
 -BILLY, Butch {V SAN}-----+ | -FENSEL, Porter {MARI}-----+
 (12) 29- 7 Bout: 58 | -AQUIRRE, Joey {MOR}-----+
 -AQUIRRE, Joey {MOR}-----+ | Fall :54
 (12) 38- 8 Bout: 295
 -YARN, Chancey {MOG}-----+ | -YARN, Chancey {MOG}-----+
 (11) 34- 8 Bout: 59 | -YARN, Chancey {MOG}-----+
 -MAGALLENZ, Tim {SUP}-----+ | Fall :57
 (12) 28- 26 Bout: 142
 -TORRES, Dustin {ANT}-----+ | -YARN, Chancey {MOG}-----+
 (10) 22- 17 Bout: 60 | -CROCKETT, Grady {PIMA}-----+
 -CROCKETT, Grady {PIMA}-----+ | Fall 1:24
 (11) 34- 16 Bout: 396
 -TREE, Leon {RED M}-----+ | -TREE, Leon {RED M}-----+
 (11) 26- 6 Bout: 61 | -TREE, Leon {RED M}-----+
 -VIRAMONTEZ, David {SAN MAN}-----+ | Fall 1:40
 (10) 18- 16 Bout: 143
 -JARVIS, Donny {BISB}-----+ | -JARVIS, Donny {BISB}-----+
 (11) 15- 8 Bout: 62 | -JARVIS, Donny {BISB}-----+
 -SCOTT, Robert {CAN ST}-----+ | Fall 1:46
 13- 9 Bout: 296
 -RIVAS, Fernando {SAN PSQ}-----+ | -RIVAS, Fernando {SAN PSQ}-----+
 (12) 19- 8 Bout: 63 | -RIVAS, Fernando {SAN PSQ}-----+
 -SHIELDS, Cory {PHX CHR}-----+ | Fall 1:24
 22- 14 Bout: 144
 -PENROD, Kendal {JO CITY}-----+ | -ALLRED, Heath {THAT}-----+
 (9) 14- 20 Bout: 64 | -ALLRED, Heath {THAT}-----+
 -ALLRED, Heath {THAT}-----+ | Fall 1:39
 (10) 37- 1 Bout: 396
 -HERNANDEZ, Rick {BOUR}-----+ | -BILLIY, Butch {V SAN}-----+
 Bout: 197 | -BILLIY, Butch {V SAN}-----+
 -BILLIY, Butch {V SAN}-----+ | Fall 3:39
 Bout: 253
 -RIVAS, Fernando {SAN PSQ}-----+
 -RIVAS, Fernando {SAN PSQ}-----+
 Fall 4:06
 Bout: 323
 -MAGALLENZ, Tim {SUP}-----+ | -MAGALLENZ, Tim {SUP}-----+
 Bout: 198 | Dec 7-2
 -TORRES, Dustin {ANT}-----+ | Bout: 254
 | -JARVIS, Donny {BISB}-----+
 | -JARVIS, Donny {BISB}-----+
 | Fall 5:11
 Bout: 395
 -VIRAMONTEZ, David {SAN MAN}-----+ | -VIRAMONTEZ, David {SAN MAN}-----+
 Bout: 199 | Dec 11-7
 -SCOTT, Robert {CAN ST}-----+ | Bout: 255
 | -CROCKETT, Grady {PIMA}-----+
 | -CROCKETT, Grady {PIMA}-----+
 | Dec :45
 | Bout: 324
 -SHIELDS, Cory {PHX CHR}-----+ | -PENROD, Kendal {JO CITY}-----+
 Bout: 200 | Forf
 -PENROD, Kendal {JO CITY}-----+ | Bout: 256
 | -AQUIRRE, Joey {MOR}-----+
 | -AQUIRRE, Joey {MOR}-----+
 | Fall 4:47
 Bout: 352
 -FENSEL, Porter {MARI}-----+
 Dec 8-3
 -RIVAS, Fernando {SAN PSQ}-----+ | -RIVAS, Fernando {SAN PSQ}-----+
 Bout: 394 | -AQUIRRE, Joey {MOR}-----+
 | -AQUIRRE, Joey {MOR}-----+
 | 5th Place
 | Fall 2:29
 - Place Winners -
 1st ALLRED, Heath {THAT} (10) 41- 1
 2nd YARN, Chancey {MOG} (11) 37- 9
 - Place Winners -
 5th AQUIRRE, Joey {MOR} (12) 42- 10
 6th RIVAS, Fernando {SAN PSQ} (12) 22- 11
 -ALLRED, Heath {THAT}-----+
 Champion
 Fall 3:47
 -TREE, Leon {RED M}-----+
 Dec 5-2
 -FENSEL, Porter {MARI}-----+
 3rd Place
 M-Dec 10-2
 -FENSEL, Porter {MARI}-----+
 Dec 8-3

3rd FENSEL, Porter {MARI} (11) 63- 7
4th TREE, Leon {RED M} (11) 29- 8

Weight: 152

```

-GUTIERREZ, David {SAN PSQ}----+
(12) 19- 2 Bout: 65 | -GUTIERREZ, David {SAN PSQ}----+
-SCHNEIDER, Thomas {HAY}-----+
(10) 33- 11 Bout: 145 | M-Dec 21-9
-Bye-----+
Bout: 66 | -FRAZIER, Joe {ST JON}-----+
-FRAZIER, Joe {ST JON}-----+
(11) 26- 12 Bout: 297 | Dec 12-5
-BRANDON, Bobby {PREC}-----+
8- 8 Bout: 67 | -BRANDON, Bobby {PREC}-----+
-JOHNSON, Arvin {M FARM}-----+
(12) 8- 9 Bout: 146 | T-Fall 15-0
-VALENTINE, Eric {V UNIO}-----+
(12) 31- 18 Bout: 68 | -INNES, Lamar {THAT}-----+
-INNES, Lamar {THAT}-----+
(12) 31- 18 Bout: 400 | Fall 4:28
-SOLOMON, Blake {JO CITY}-----+
(10) 37- 1 Bout: 69 | -SOLOMON, Blake {JO CITY}-----+
-RAMOS, Hugo {BOUR}-----+
20- 16 Bout: 147 | Fall 1:04
-MALBOEUF, Cody {BENS}-----+
(11) 23- 11 Bout: 70 | -KELLY, Darin {SAN MAN}-----+
-KELLY, Darin {SAN MAN}-----+
(11) 29- 9 Bout: 298 | T-Fall 19-2
-HAMM, Karl {MARI}-----+
(11) 39- 20 Bout: 71 | -MERRILL, Ryan {MOR}-----+
-MERRILL, Ryan {MOR}-----+
(12) 25- 10 Bout: 148 | Fall 3:16
-Bye-----+
Bout: 72 | -CASTILLO, Juan {CAN ST}-----+
-CASTILLO, Juan {CAN ST}-----+
15- 6 Bout: 201 | -SCHNEIDER, Thomas {HAY}-----+
-Bye-----+
Bout: 257 | -SCHNEIDER, Thomas {HAY}-----+
-CASTILLO, Juan {CAN ST}-----+
-JOHNSON, Arvin {M FARM}-----+
Bout: 202 | -VALENTINE, Eric {V UNIO}-----+
-VALENTINE, Eric {V UNIO}-----+
M-Dec 14-2 Bout: 258 | -KELLY, Darin {SAN MAN}-----+
-KELLY, Darin {SAN MAN}-----+
Fall :59 Bout: 325 | -KELLY, Darin {SAN MAN}-----+
-FRAZIER, Joe {ST JON}-----+
Dec 6-5 Bout: 354 | -GUTIERREZ, David {SAN PSQ}-----+
Dec 7-3
-FRAZIER, Joe {ST JON}-----+
M-Dec 13-2 Bout: 398 | -MERRILL, Ryan {MOR}-----+
-MERRILL, Ryan {MOR}-----+
Bout: 398 | 5th Place
Dec 8-2
-FRAZIER, Joe {ST JON}-----+
- Place Winners -
1st INNES, Lamar {THAT} (12) 35- 18
2nd SOLOMON, Blake {JO CITY} (10) 40- 2
3rd KELLY, Darin {SAN MAN} (11) 34- 10
4th GUTIERREZ, David {SAN PSQ} (12) 22- 4
- Place Winners -
5th MERRILL, Ryan {MOR} (12) 28- 12
6th FRAZIER, Joe {ST JON} (11) 28- 15

```

Weight: 160

```

-TAYLOR, Wesley {BISB}-----+
(11) 38- 7 Bout: 73 | -TAYLOR, Wesley {BISB}-----+
-SHREEVE, Charlie {ST JON}-----+
Fall 1:38
(11) 14- 9 Bout: 149 | -TAYLOR, Wesley {BISB}-----+
-RIVERA, Manny {HAY}-----+
(10) 17- 16 Bout: 74 | -RAEL, Travis {CAN ST}-----+
-RAEL, Travis {CAN ST}-----+
30- 7 Bout: 299 | Dec 9-6
-TAYLOR, Kyle {THAT}-----+
(12) 24- 17 Bout: 75 | -TAYLOR, Kyle {THAT}-----+
-ANGER, Jamie {PIMA}-----+
M-Dec 14-5
(9) 21- 22 Bout: 150 | -TAYLOR, Kyle {THAT}-----+
-RAMIREZ, Erick {SAN PSQ}-----+
(11) 16- 15 Bout: 76 | -JOHN, Dewayne {RED M}-----+
-JOHN, Dewayne {RED M}-----+
(12) 20- 7 Bout: 404 | Dec 11-8
-GINGG, Rocky {PHX CHR}-----+
22- 8 Bout: 77 | -GINGG, Rocky {PHX CHR}-----+
-STRICKLIN, Jeremiah {FLOR}-----+
Fall :57
(9) 14- 18 Bout: 151 | -FIERROS, Matthew {MARI}-----+
-SERVIS, A.J. {MOG}-----+
(11) 30- 7 Bout: 78 | -FIERROS, Matthew {MARI}-----+
-FIERROS, Matthew {MARI}-----+
(9) 55- 9 Bout: 300 | Fall 1:45
-PETERSON, Casey {JO CITY}-----+
(11) 28- 19 Bout: 79 | -CARRILLO, Cruz {ANT}-----+
-CARRILLO, Cruz {ANT}-----+
Fall 1:13
(12) 15- 11 Bout: 152 | -FRANCO, Andre {MOR}-----+
-SANCHEZ, Daniel {BOUR}-----+
11- 10 Bout: 80 | -FRANCO, Andre {MOR}-----+
-FRANCO, Andre {MOR}-----+
(12) 50- 4 Bout: 155 | Fall 1:15
-Bye-----+
Bout: 205 | -SHREEVE, Charlie {ST JON}-----+
-RIVERA, Manny {HAY}-----+
Fall 2:30
Bout: 261 | -SHREEVE, Charlie {ST JON}-----+
-CARRILLO, Cruz {ANT}-----+
Fall 1:36
Bout: 355 | -FIERROS, Matthew {MARI}-----+
-FIERROS, Matthew {MARI}-----+
Fall 4:40

```

Brackets

Bout: 327

-GINGG, Rocky {PHX CHR}-----+
Fall 2:04

-ANGER, Jamie {PIMA}-----+
Bout: 206

-RAMIREZ, Erick {SAN PSQ}-----+
Dec 9-2

-RAMIREZ, Erick {SAN PSQ}-----+
Bout: 262

-GINGG, Rocky {PHX CHR}-----+
Fall 1:21

Bout: 403

-RAEL, Travis {CAN ST}-----+
3rd Place
Dec 4-2

-STRICKLIN, Jeremiah {FLOR}-----+
Bout: 207

-SERVIS, A.J. {MOG}-----+
Fall 2:15

-SERVIS, A.J. {MOG}-----+
Bout: 263

-JOHN, Dewayne {RED M}-----+
Fall 3:19

Bout: 328

-RAEL, Travis {CAN ST}-----+
Dec 5-1

-PETERSON, Casey {JO CITY}-----+
Bout: 208

-PETERSON, Casey {JO CITY}-----+
Fall 4:42

-SAN-CHEZ, Daniel {BOUR}-----+
Bout: 264

-RAEL, Travis {CAN ST}-----+
Fall 3:19

Bout: 356

-RAEL, Travis {CAN ST}-----+
Dec 3-1

-RAYMOND, Kyle {THAT}-----+
Fall 4:15

-GINGG, Rocky {PHX CHR}-----+
Bout: 402

-GINGG, Rocky {PHX CHR}-----+
5th Place
Fall 4:15

-TAYLOR, Kyle {THAT}-----+
Fall 4:15

- Place Winners -

1st FRANCO, Andre {MOR}	(12)	54-	4
2nd TAYLOR, Wesley {BISB}	(11)	41-	8
3rd RAE, Travis {CAN ST}		35-	8
4th FIERROS, Matthew {MARI}	(9)	58-	11

- Place Winners -

5th GINGG, Rocky {PHX CHR}		26-	10
6th TAYLOR, Kyle {THAT}	(12)	26-	20

Weight: 171

-VALLEAU, John {YUMA C}-----+
(12) 32- 7 Bout: 81

-VINER, Vincent {CAN ST}-----+
5- 8 Bout: 153

-VALLEAU, John {YUMA C}-----+
Fall 5:01

-ROGERS, Aaron {JO CITY}-----+
(11) 17- 16 Bout: 82

-GAETHJE, Jacob {MOR}-----+
(10) 12- 5 Bout: 301

-CHEE, Jamison {M FARM}-----+
(10) 29- 8 Bout: 83

-MONFRED, Wade {SAN MAN}-----+
(11) 21- 11 Bout: 154

-MANER, Jonathan {PIMA}-----+
Fall 1:28

-KEISER, Logan {ANT}-----+
(9) 11- 14 Bout: 84

-MANER, Jonathan {PIMA}-----+
Dec 14-8

-WILLIE, Tyrell {R ROCK}-----+
(12) 22- 6 Bout: 85

-BOGGS, Anthony {SUP}-----+
(12) 18- 12 Bout: 155

-WILLIE, Tyrell {R ROCK}-----+
Fall 1:52

-LACAGNINA, Paul {BOUR}-----+
Bout: 302

-HOUSEHOLDER, Travis {THAT}---
Champion
M-Dec 11-2

-GILES, Aubry {BISB}-----+
(12) 22- 11 Bout: 87

-TOSCANO, Michael {PHX CHR}-----+
26- 14 Bout: 156

-HOUSEHOLDER, Travis {THAT}---
Fall 2:50

-CROSBY, Elliot {ST JON}-----+
(10) 20- 17 Bout: 88

-HOUSEHOLDER, Travis {THAT}---
Fall 3:49

-VINER, Vincent {CAN ST}-----+
Bout: 209

-GAETHJE, Jacob {MOR}-----+
Fall 2:48

-TOSCANO, Michael {PHX CHR}-----+
Bout: 265

-GAETHJE, Jacob {MOR}-----+
Dec 9-7

Bout: 329

-LACAGNINA, Paul {BOUR}-----+
Fall 2:19

-MONFRED, Wade {SAN MAN}-----+
Bout: 210

-MONFRED, Wade {SAN MAN}-----+
Fall 2:19

-LACAGNINA, Paul {BOUR}-----+
Dec 6-3

-KEISER, Logan {ANT}-----+
Bout: 266

-LACAGNINA, Paul {BOUR}-----+
Dec 6-3

-WILLIE, Tyrell {R ROCK}-----+
Bout: 357

-LACAGNINA, Paul {BOUR}-----+
Fall 1:19

-BOGGS, Anthony {SUP}-----+
Bout: 211

-BOGGS, Anthony {SUP}-----+
Bout: 267

-CHEE, Jamison {M FARM}-----+
Fall 1:48

Bout: 330

-CHEE, Jamison {M FARM}-----+
Fall :43

-GILES, Aubry {BISB}-----+
Bout: 212

-CROSBY, Elliot {ST JON}-----+
Fall 2:38

-ROGERS, Aaron {JO CITY}-----+
Dec 12-10

-VALLEAU, John {YUMA C}-----+
Bout: 406

-WILLIE, Tyrell {R ROCK}-----+
5th Place
Dec 1-0

-CROSBY, Elliot {ST JON}-----+
Bout: 268

-ROGERS, Aaron {JO CITY}-----+
Dec 12-10

-VALLEAU, John {YUMA C}-----+
Bout: 407

-CHEE, Jamison {M FARM}-----+
3rd Place
Fall 2:48

- Place Winners -

1st HOUSEHOLDER, Travis {THAT}	(12)	33-	3
2nd MANER, Jonathan {PIMA}	(11)	38-	19
3rd CHEE, Jamison {M FARM}	(10)	34-	9
4th LACAGNINA, Paul {BOUR}		28-	15

- Place Winners -

5th WILLIE, Tyrell {R ROCK}	(12)	25-	8
6th VALLEAU, John {YUMA C}	(12)	34-	10

Weight: 189

-COATE, Ben {P RDGE}-----+
(12) 42- 7 Bout: 89

-SUSUNKEMA, Stephen {SAN CAR}--
(11) 48- 31 Bout: 157

-COATE, Ben {P RDGE}-----+
M-Dec 14-3

-SHEA, Jon {PHX DAY}-----+
20- 5 Bout: 90

-BEGAY, Lutherio {M FARM}-----+
(9) 21- 8

-HIXON, Drew {PHX CHR}-----+
Bout: 303

-COATE, Ben {P RDGE}-----+
Dec 8-1

-COATE, Ben {P RDGE}-----+
Dec 5-3

<p>12- 9 Bout: 91 -HIXON, Drew {PHX CHR}-----+ -RODGERS, Blake {ST JON}-----+ (12) 13- 9 Bout: 158 -CHRISTIMAT, Cole {V UNIO}-----+ (9) 9- 11 Bout: 92 -ALVARADO, Nick {HAY}-----+ -ALVARADO, Nick {HAY}-----+ (12) 40- 6 -BRENNON, Andy {JO CITY}-----+ (12) 28- 2 Bout: 93 -BRENNON, Andy {JO CITY}-----+ -Bye-----+ Bout: 159 -ZAMUDIO, Estaban {BENS}-----+ (12) 19- 12 Bout: 94 -GARCIA, John {FLOR}-----+ -GARCIA, John {FLOR}-----+ (11) 28- 7 -JAIME, Mark {ANT}-----+ (12) 36- 9 Bout: 95 -JAIME, Mark {ANT}-----+ -BURKETT, Kyle {MOR}-----+ (12) 19- 12 Bout: 160 -Bye-----+ Bout: 96 -SHANNON, Tim {BOUR}-----+ -SHANNON, Tim {BOUR}-----+ 21- 11 -SUSUNKEWA, Stephen {SAN CAR}-----+ Bout: 213 -SUSUNKEWA, Stephen {SAN CAR}-----+ -SHEA, Jon {PHX DAY}-----+ Bout: 269 -JAIME, Mark {ANT}-----+ -RODGERS, Blake {ST JON}-----+ Bout: 214 -CHRISTIMAT, Cole {V UNIO}-----+ -CHRISTIMAT, Cole {V UNIO}-----+ Bout: 270 -GARCIA, John {FLOR}-----+ -GARCIA, John {FLOR}-----+ Bout: 215 -ZAMUDIO, Estaban {BENS}-----+ -ZAMUDIO, Estaban {BENS}-----+ Bout: 271 -HIXON, Drew {PHX CHR}-----+ -BURKETT, Kyle {MOR}-----+ Bout: 216 -BURKETT, Kyle {MOR}-----+ -Bye-----+ Bout: 272 -BURKETT, Kyle {MOR}-----+ -BEGAY, Lutherio {M FARM}-----+ -SHANNON, Tim {BOUR}-----+ Bout: 410 -ZAMUDIO, Estaban {BENS}-----+ -ZAMUDIO, Estaban {BENS}-----+ Bout: 332</p>	<p>-ALVARADO, Nick {HAY}-----+ Fall 3:58 Bout: 412 -BRENNON, Andy {JO CITY}-----+ Champion Fall 4:18 Bout: 304 -BRENNON, Andy {JO CITY}-----+ Fall 3:48 -SHANNON, Tim {BOUR}-----+ Dec 11-5 -SHANNON, Tim {BOUR}-----+ Bout: 359 -GARCIA, John {FLOR}-----+ M-Dec 17-5 -GARCIA, John {FLOR}-----+ Dec 8-2 Bout: 411 -ALVARADO, Nick {HAY}-----+ 3rd Place Dec 9-7 -ALVARADO, Nick {HAY}-----+ Fall 4:31 -ALVARADO, Nick {HAY}-----+ -ZAMUDIO, Estaban {BENS}-----+ 5th Place Dec 6-3</p>	<p>- Place Winners - 1st BRENNON, Andy {JO CITY} (12) 31- 2 2nd COATE, Ben {P RDGE} (12) 45- 8 3rd ALVARADO, Nick {HAY} (12) 44- 7 4th GARCIA, John {FLOR} (11) 32- 9</p>	<p>- Place Winners - 5th ZAMUDIO, Estaban {BENS} (12) 22- 14 6th SHANNON, Tim {BOUR} 22- 14</p>
---	--	---	---

Weight: 215

<p>-LANGHAM, Sean {BISB}-----+ (12) 45- 1 Bout: 97 -LANGHAM, Sean {BISB}-----+ -Bye-----+ Bout: 161 -DONAHUE, Patrick {THAT}-----+ (10) 32- 13 Bout: 98 -GAKO, J.P {V CHR}-----+ -GAKO, J.P {V CHR}-----+ (12) 24- 4 -CLINTON, E.J. {SAN MAN}-----+ (11) 32- 13 Bout: 99 -CLINTON, E.J. {SAN MAN}-----+ -FARRINGTON, Brad {PIMA}-----+ (12) 30- 15 Bout: 162 -GARCIA, Jesse {BABO}-----+ (12) 2- 7 Bout: 100 -DESPAIN, Craig {MOG}-----+ -DESPAIN, Craig {MOG}-----+ (11) 34- 4 -THOMPSON, Andrew {PHX CHR}-----+ (12) 24- 1 Bout: 101 -THOMPSON, Andrew {PHX CHR}-----+ -GOODE, Jeremy {SAN CAR}-----+ (10) 11- 28 Bout: 163 -Bye-----+ Bout: 102 -MAIN, Matt {MARI}-----+ -MAIN, Matt {MARI}-----+ (10) 39- 22 -TSOSIE, Wayne {RED M}-----+ (12) 18- 10 Bout: 103 -TSOSIE, Wayne {RED M}-----+ -GERGAN, Eric {BENS}-----+ (9) 10- 9 Bout: 164 -SCHURZ, Jacob {SALT R}-----+ 5- 17 Bout: 104 -GARCIA, Rupert {MOR}-----+ -GARCIA, Rupert {MOR}-----+ (12) 30- 15 -Bye-----+ Bout: 217 -DONAHUE, Patrick {THAT}-----+ -DONAHUE, Patrick {THAT}-----+ Bout: 273 -GARCIA, Rupert {MOR}-----+ -FARRINGTON, Brad {PIMA}-----+ Bout: 218 -FARRINGTON, Brad {PIMA}-----+ -GARCIA, Jesse {BABO}-----+ Bout: 274 -MAIN, Matt {MARI}-----+ -GOODE, Jeremy {SAN CAR}-----+ Bout: 219 -GOODE, Jeremy {SAN CAR}-----+ -Bye-----+ Bout: 275 -CLINTON, E.J. {SAN MAN}-----+ -GERGAN, Eric {BENS}-----+ Bout: 220 -GERGAN, Eric {BENS}-----+ -SCHURZ, Jacob {SALT R}-----+ Bout: 276 -GAKO, J.P {V CHR}-----+ -GAKO, J.P {V CHR}-----+ Bout: 335</p>	<p>-LANGHAM, Sean {BISB}-----+ Fall 2:44 Bout: 305 -DESPAIN, Craig {MOG}-----+ Fall 2:56 -DESPAIN, Craig {MOG}-----+ Fall 1:28 Bout: 416 -THOMPSON, Andrew {PHX CHR}-----+ Champion Dec 8-7 -THOMPSON, Andrew {PHX CHR}-----+ T-Fall 18-1 Bout: 306 -THOMPSON, Andrew {PHX CHR}-----+ Fall 1:09 -TSOSIE, Wayne {RED M}-----+ Fall 5:56 -TSOSIE, Wayne {RED M}-----+ Fall 3:06 -TSOSIE, Wayne {RED M}-----+ Bout: 361 -GARCIA, Rupert {MOR}-----+ M-Dec 9-1 -GARCIA, Rupert {MOR}-----+ Dec 6-3 Bout: 333 -GARCIA, Rupert {MOR}-----+ Fall 4:59 -FARRINGTON, Brad {PIMA}-----+ Dec 11-7 Bout: 415 -LANGHAM, Sean {BISB}-----+ 3rd Place Fall :57 -CLINTON, E.J. {SAN MAN}-----+ Fall :42 Bout: 362 -LANGHAM, Sean {BISB}-----+ Fall 1:50 -LANGHAM, Sean {BISB}-----+ -LANGHAM, Sean {BISB}-----+ Fall 3:35</p>
--	---

-TSOSIE, Wayne {RED M}-----+
 Bout: 414 | -CLINTON, E.J. {SAN MAN}-----
 -CLINTON, E.J. {SAN MAN}-----+
 5th Place
 Fall 2:10

- Place Winners -
 1st THOMPSON, Andrew {PHX CHR} (12) 28- 1
 2nd DESPAIN, Craig {MOG} (11) 37- 5
 3rd LANGHAM, Sean {BISB} (12) 48- 2
 4th GARCIA, Rupert {MOR} (12) 34- 17

- Place Winners -
 5th CLINTON, E.J. {SAN MAN} (11) 36- 15
 6th TSOSIE, Wayne {RED M} (12) 20- 13

Weight: 275

```

- HURTADO, Julio {YUMA C}-----+
(12) 31- 11 Bout: 105 | -HURTADO, Julio {YUMA C}-----+
- Bye-----+
Bout: 165
- RUTHERFORD, Curtis {MOG}-----+
(11) 14- 19 Bout: 106 | -MAGALLANEZ, Ignacio {SUP}-----+
- MAGALLANEZ, Ignacio {SUP}-----+
(12) 43- 8 Bout: 307
- MILLER, Kevin {R ROCK}-----+
(11) 7- 16 Bout: 107 | -TELLEZ, Johnny {THAT}-----+
- TELLEZ, Johnny {THAT}-----+
(10) 24- 5 Bout: 166
- MCGINNIS, Zack {BISB}-----+
(10) 1- 2 Bout: 108 | -SMITH, Ben {PHX CHR}-----+
- SMITH, Ben {PHX CHR}-----+
(12) 47- 0 Bout: 420
- BEGAY, Larusso {M FARM}-----+
(10) 27- 8 Bout: 109 | -BEGAY, Larusso {M FARM}-----+
- MARTINEZ, Stephen {SAN CAR}-----+
(10) 28- 28 Bout: 167
- SALAZAR, Cris {ANT}-----+
(12) 15- 10 Bout: 110 | -WALSH, Pat {BOUR}-----+
- WALSH, Pat {BOUR}-----+
14- 5 Bout: 308
- ANTONE, Callum {BABO}-----+
(10) 6- 3 Bout: 111 | -ANTONE, Callum {BABO}-----+
- JUAN, Mike {SALT R}-----+
10- 13 Bout: 168
- MARYBOY, Skylar {RED M}-----+
(11) 4- 10 Bout: 112 | -GONZALES, Chris {MOR}-----+
- GONZALES, Chris {MOR}-----+
(11) 20- 2 Bout: 168
- Bye-----+
Bout: 221
- RUTHERFORD, Curtis {MOG}-----+
- RUTHERFORD, Curtis {MOG}-----+
Bout: 277
- ANTONE, Callum {BABO}-----+
- ANTONE, Callum {BABO}-----+
Bout: 335
- MILLER, Kevin {R ROCK}-----+
Bout: 222 | -MILLER, Kevin {R ROCK}-----+
- MCGINNIS, Zack {BISB}-----+
Fall 3:39
Bout: 278
- WALSH, Pat {BOUR}-----+
- WALSH, Pat {BOUR}-----+
Fall 1:30
- MARTINEZ, Stephen {SAN CAR}-----+
Bout: 223 | -SALAZAR, Cris {ANT}-----+
- SALAZAR, Cris {ANT}-----+
Fall 1:22
Bout: 279
- TELLEZ, Johnny {THAT}-----+
- TELLEZ, Johnny {THAT}-----+
Dec 9-2
Bout: 336
- JUAN, Mike {SALT R}-----+
Bout: 224 | -MARYBOY, Skylar {RED M}-----+
- MARYBOY, Skylar {RED M}-----+
Dec 10-8
Bout: 280
- HURTADO, Julio {YUMA C}-----+
- HURTADO, Julio {YUMA C}-----+
Fall 2:19
- HURTADO, Julio {YUMA C}-----+
Bout: 364
- MAGALLANEZ, Ignacio {SUP}-----+
- MAGALLANEZ, Ignacio {SUP}-----+
Dec 3-2
- ANTONE, Callum {BABO}-----+
Bout: 418 | -ANTONE, Callum {BABO}-----+
- HURTADO, Julio {YUMA C}-----+
5th Place
Fall 4:51

- Place Winners -
1st SMITH, Ben {PHX CHR} (12) 51- 0
2nd GONZALES, Chris {MOR} (11) 23- 3
3rd MAGALLANEZ, Ignacio {SUP} (12) 47- 9
4th BEGAY, Larusso {M FARM} (10) 30- 10

- Place Winners -
5th ANTONE, Callum {BABO} (10) 10- 5
6th HURTADO, Julio {YUMA C} (12) 33- 14
    
```

Preferred Educational Software

9585 Woodgate Lane

Byron IL 61010

Phone: (888) 959-2016

e-mail: cotterk@pes-sports.com

(c) 2001 - All rights reserved

Glendale Arena

2004-05 Arizona 3A State Tournament

Team Scores

February 11-12, 2005

1.	Safford	216.00
2.	Camp Verde	208.00
3.	Show Low	127.00
4.	Rio Rico	103.50
5.	Sahuarita	101.00
6.	Blue Ridge	84.50
7.	Coolidge	83.00
8.	Higley	78.50
9.	Round Valley	75.00
10.	Winslow	70.00
11.	Tuba City	59.00
12.	Parker	58.50
13.	Holbrook	55.50
14.	Queen Creek	50.50
15.	Snowflake	46.50
16.	Willcox	45.50
17.	Fountain Hills	43.00
18.	Window Rock	38.00
19.	Ganado	34.00
20.	Estrella Foothills	33.00
21.	Santa Cruz	32.00
22.	Monument Valley	25.00
23.	Pinon	18.00
24.	River Valley	16.00
25.	Chino Valley	12.00
26.	Hopi	9.00
27.	Globe	8.00
28.	Greyhills	7.00
29.	Wickenburg	5.50
30.	Seton Catholic	2.00
31.	Alchesay	0.00
31. (tie)	Sedona	0.00

Tourney Contact

Greg Wayne

Monument Valley High School

PO Box 337

Kayenta AZ 86033

e-mail: gwayne@kayenta.k12.az.us**Publisher****Preferred Educational Software**

9585 Woodgate Lane

Byron IL 61010

Phone: (888) 959-2016

e-mail: cotterk@pes-sports.com

© 2001 - All rights reserved

2004-05 Arizona 3A State Tournament

Glendale Arena

February 11-12, 2005

Weight: 103

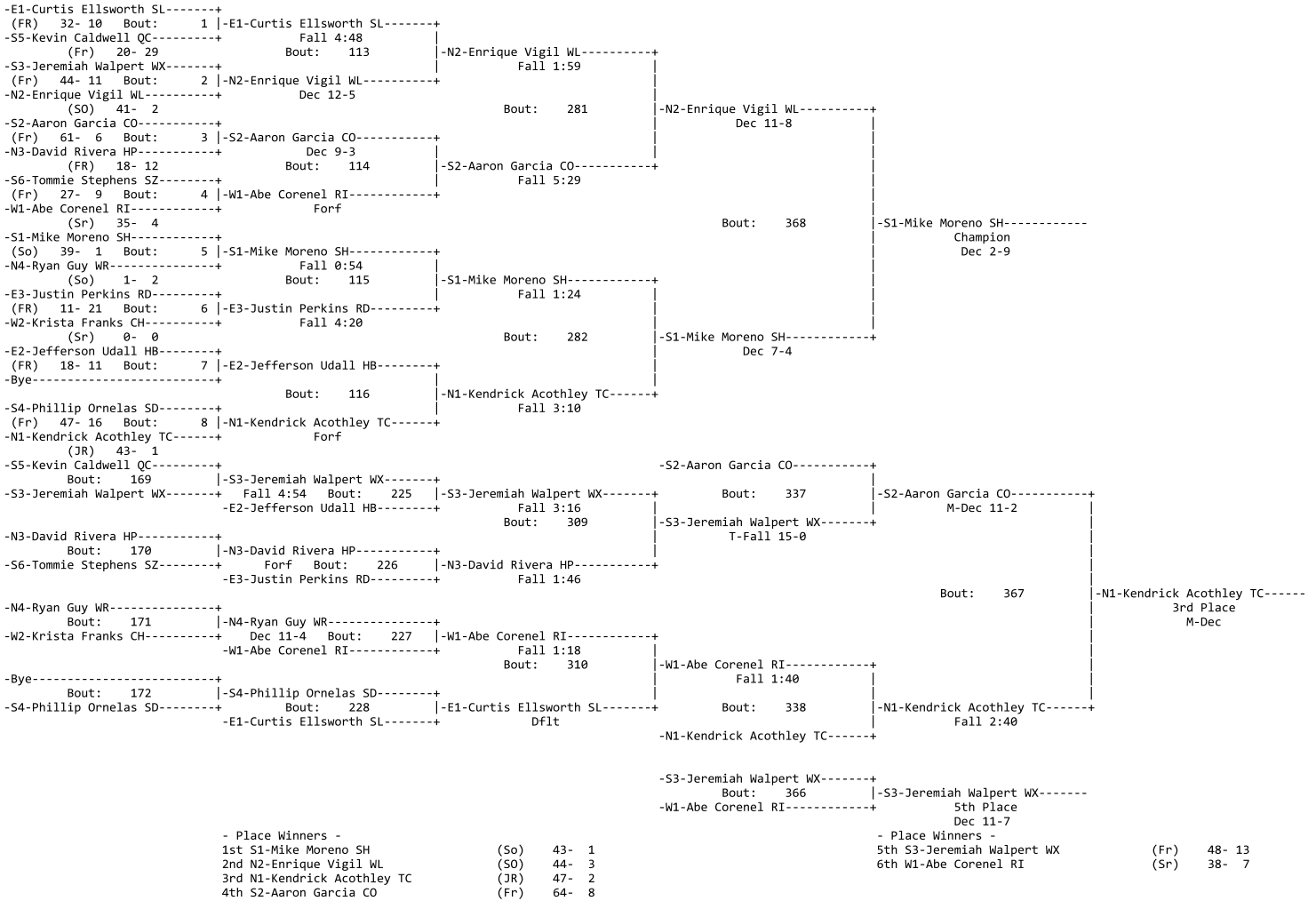

Weight: 112

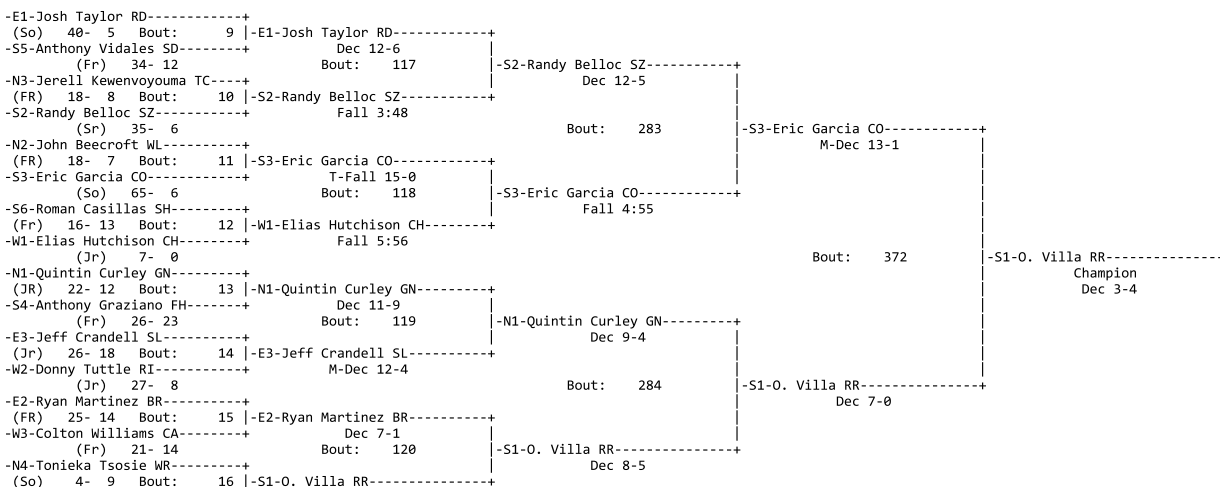

-S1-0. Villa RR-----+ (Sr) 37- 3	Fall :52					
-S5-Anthony Vidales SD-----+ Bout: 173		-S5-Anthony Vidales SD-----+ Fall 4:45 Bout: 229		-S2-Randy Belloc SZ-----+ Bout: 339		
-N3-Jerell Kewenvoyouma TC-----+ -E2-Ryan Martinez BR-----+		-S5-Anthony Vidales SD-----+ Dec 5-1		-S2-Randy Belloc SZ-----+ M-Dec 14-9		
-N2-John Beecroft WL-----+ Bout: 174		Bout: 311		-S5-Anthony Vidales SD-----+ Dec 9-7		
-S6-Roman Casillas SH-----+ Dec 8-6 Bout: 230		-E3-Jeff Crandell SL-----+ Dflt				
-E3-Jeff Crandell SL-----+				Bout: 371	-S2-Randy Belloc SZ-----+ 3rd Place Fall :50	
-S4-Anthony Graziano FH-----+ Bout: 175		-W2-Donny Tuttle RI-----+ Dec 3-1 Bout: 231		-W2-Donny Tuttle RI-----+ M-Dec 10-1		
-W2-Donny Tuttle RI-----+		-W1-Elias Hutchison CH-----+		Bout: 312		
-W3-Colton Williams CA-----+ Bout: 176		-W3-Colton Williams CA-----+ M-Dec 13-1 Bout: 232		-E1-Josh Taylor RD-----+ Fall 4:39		
-N4-Tonieka Tosie WR-----+ -E1-Josh Taylor RD-----+		-E1-Josh Taylor RD-----+ Fall 4:12		Bout: 340	-E1-Josh Taylor RD-----+ Fall 3:18	
				-N1-Quintin Curley GN-----+		
				-S5-Anthony Vidales SD-----+ Bout: 370		
				-N1-Quintin Curley GN-----+ 5th Place M-Dec 14-5		
- Place Winners -				- Place Winners -		
1st S1-0. Villa RR	(Sr)	41- 3		5th S5-Anthony Vidales SD	(Fr)	38- 14
2nd S3-Eric Garcia CO	(So)	68- 7		6th N1-Quintin Curley GN	(JR)	24- 15
3rd S2-Randy Belloc SZ	(Sr)	39- 7				
4th E1-Josh Taylor RD	(So)	44- 7				

Weight: 119

-N1-Tommy Taylor WL-----+ (JR) 29- 12 Bout: 17		-N1-Tommy Taylor WL-----+ M-Dec 10-0				
-S5-JJ Claypeck RR-----+ (So) 18- 13		Bout: 121		-N1-Tommy Taylor WL-----+ Forf		
-E3-Travis Leigh BR-----+ (So) 20- 9 Bout: 18		-Forfeit-----+				
-S2-Aaron Belloc SZ-----+ (Fr) 41- 5		Forf		Bout: 285	-W1-Josh Wolfe CA-----+ Dec 9-3	
-E2-Bryce Bigham RD-----+ (Fr) 9- 24 Bout: 19		-S3-David Lerma SH-----+ Dec 11-9				
-S3-David Lerma SH-----+		Bout: 122		-W1-Josh Wolfe CA-----+ M-Dec 13-5		
-N4-Derek Yellow GR-----+ (SO) 2- 2 Bout: 20		-W1-Josh Wolfe CA-----+ Forf		Bout: 376	-W1-Josh Wolfe CA-----+ Champion Dec 9-7	
-W1-Josh Wolfe CA-----+		(So) 29- 7				
-E1-John Serna HB-----+ (Sr) 29- 7 Bout: 21		-E1-John Serna HB-----+ T-Fall 15-0				
-S4-Palmer Bingham SD-----+ (Fr) 8- 4		Bout: 123		-E1-John Serna HB-----+ Dec 9-4		
-N3-Hoover Nasingoetewa HP-----+ (JR) 16- 10 Bout: 22		-W2-Seth Carpenter PK-----+ M-Dec 10-2		Bout: 286	-S1-Tod Workman QC-----+ Dec 7-1	
-W2-Seth Carpenter PK-----+		(So) 40- 15				
-N2-Rolaniel Sloan TC-----+ (FR) 17- 10 Bout: 23		-W3-Matt DelCerro CH-----+ Fall 4:24		-S1-Tod Workman QC-----+ Fall 2:33		
-W3-Matt DelCerro CH-----+		(Fr) 0- 0				
-S6-Daniel Baldenegro CO-----+ (So) 28- 21 Bout: 24		-S1-Tod Workman QC-----+ M-Dec 12-4				
-S1-Tod Workman QC-----+		(Fr) 47- 9				
-S5-JJ Claypeck RR-----+ Bout: 177		-S5-JJ Claypeck RR-----+ Forf Bout: 233		-N1-Tommy Taylor WL-----+ Bout: 341		
-Forfeit-----+		-W3-Matt DelCerro CH-----+		-N1-Tommy Taylor WL-----+ Dec 6-5		
				-W2-Seth Carpenter PK-----+ Dec 6-2		
-E2-Bryce Bigham RD-----+ Bout: 178		-E2-Bryce Bigham RD-----+ Forf Bout: 234				
-N4-Derek Yellow GR-----+ -W2-Seth Carpenter PK-----+		-W2-Seth Carpenter PK-----+ Fall 2:31		Bout: 375	-E1-John Serna HB-----+ 3rd Place Dec 0-5	
-S4-Palmer Bingham SD-----+ Bout: 179		-S4-Palmer Bingham SD-----+ T-Fall 20-2 Bout: 235				
-N3-Hoover Nasingoetewa HP-----+ -S3-David Lerma SH-----+		-S3-David Lerma SH-----+ Dec 7-5		-S4-Palmer Bingham SD-----+ M-Dec 13-1		
		Bout: 314		Bout: 342	-E1-John Serna HB-----+ Dec 8-2	
-N2-Rolaniel Sloan TC-----+ Bout: 180		-S6-Daniel Baldenegro CO-----+ Fall 2:08 Bout: 236		-S6-Daniel Baldenegro CO-----+ Forf		
-S6-Daniel Baldenegro CO-----+		-Forfeit-----+		-E1-John Serna HB-----+		
				-W2-Seth Carpenter PK-----+ Bout: 374		
				-S4-Palmer Bingham SD-----+ 5th Place Dec 5-11		
- Place Winners -				- Place Winners -		
1st W1-Josh Wolfe CA	(So)	33- 7		5th S4-Palmer Bingham SD	(Fr)	12- 6
2nd S1-Tod Workman QC	(Fr)	50- 10		6th W2-Seth Carpenter PK	(So)	43- 18
3rd E1-John Serna HB	(Sr)	33- 8				
4th N1-Tommy Taylor WL	(JR)	32- 14				

Weight: 125

-W1-Mick Maya PK-----+ (So) 42- 11 Bout: 25		-W1-Mick Maya PK-----+ T-Fall 16-1			
-S5-Miguel Lopez SH-----+ (Sr) 16- 9		Bout: 125		-N2-Daniel Bailon WL-----+ Dec 5-3	
-S3-Cody Degroot QC-----+ (Jr) 44- 16 Bout: 26		-N2-Daniel Bailon WL-----+ Dec 7-5			
-N2-Daniel Bailon WL-----+		(JR) 5- 1		Bout: 287	-S2-Eric Romero SD-----+ Fall 2:37
-S2-Eric Romero SD-----+		(Sr) 50- 4 Bout: 27		-S2-Eric Romero SD-----+	

-N3-Bryan Martinez TC-----+ Fall :58
(SR) 3- 1 Bout: 126 | -S2-Eric Romero SD-----+
-S6-Greg Zupancic GL-----+ Dec 3-1
(Jr) 19- 16 Bout: 28 | -E1-Anthony Martinez BR-----+
-E1-Anthony Martinez BR-----+ Fall 2:19 Bout: 380 | -S2-Eric Romero SD-----+
(Jr) 22- 0 | | Champion
-S1-Jacob Kauffman FH-----+ M-Dec 9-0
(So) 51- 3 Bout: 29 | -S1-Jacob Kauffman FH-----+
-N4-Ernest Nez WR-----+ Fall 1:48
(Jr) 5- 6 Bout: 127 | -S1-Jacob Kauffman FH-----+
-W3-Alex Goodman WK-----+ Dec 5-3
(Jr) 25- 12 Bout: 30 | -E2-Bo Mortensen SF-----+
-E2-Bo Mortensen SF-----+ Fall 5:59 Bout: 288 | -S1-Jacob Kauffman FH-----+
(Jr) 31- 8 | | Fall 3:56
-W2-Jacob Wolfe CA-----+
(Fr) 26- 12 Bout: 31 | -E3-Rich Serna HB-----+
-E3-Rich Serna HB-----+ Dec 9-4
(Fr) 22- 11 Bout: 128 | -N1-Josh Sholley GN-----+
-S4-Mike Dooley WX-----+ Fall 5:39
(Jr) 25- 22 Bout: 32 | -N1-Josh Sholley GN-----+
-N1-Josh Sholley GN-----+ M-Dec 15-6
(JR) 36- 6 | |
-S5-Miguel Lopez SH-----+
Bout: 181 | -S3-Cody Degroot QC-----+
-S3-Cody Degroot QC-----+ Dec 10-8 Bout: 237 | -E3-Rich Serna HB-----+
| | Dec 10-8 Bout: 315 | -E2-Bo Mortensen SF-----+
-N3-Bryan Martinez TC-----+ | | Fall 4:26 | -E2-Bo Mortensen SF-----+
Bout: 182 | -S6-Greg Zupancic GL-----+ | | Bout: 379 | -E1-Anthony Martinez BR-----+
-S6-Greg Zupancic GL-----+ Dec 10-6 Bout: 238 | -E2-Bo Mortensen SF-----+ | | 3rd Place
| | Fall 2:07 | | Dec 2-9
-N4-Ernest Nez WR-----+ | | | |
Bout: 183 | -W3-Alex Goodman WK-----+ | |
-W3-Alex Goodman WK-----+ T-Fall 18-3 Bout: 239 | -E1-Anthony Martinez BR-----+
| | M-Dec 15-4 | |
-E1-Anthony Martinez BR-----+ Bout: 316 | -E1-Anthony Martinez BR-----+
-W2-Jacob Wolfe CA-----+ | | Fall 4:40 | |
Bout: 184 | -S4-Mike Dooley WX-----+ | |
-S4-Mike Dooley WX-----+ Fall :49 Bout: 240 | -W1-Mick Maya PK-----+ | |
| | T-Fall 17-0 | | Bout: 344 | -E1-Anthony Martinez BR-----+
-W1-Mick Maya PK-----+ | | M-Dec 11-1
| | | |
-N1-Josh Sholley GN-----+
| |
-N2-Daniel Bailon WL-----+
Bout: 378 | -N1-Josh Sholley GN-----+
-N1-Josh Sholley GN-----+ | | 5th Place
| | M-Dec 1-11
- Place Winners -
1st S2-Eric Romero SD (Sr) 54- 4
2nd S1-Jacob Kauffman FH (So) 54- 4
3rd E1-Anthony Martinez BR (Jr) 27- 1
4th E2-Bo Mortensen SF (Jr) 35- 10

Weight: 130

-N1-Ryan Salt MV-----+
(JR) 31- 9 Bout: 33 | -N1-Ryan Salt MV-----+
-S5-Tyler Rogers WX-----+ Dec 8-5
(Sr) 37- 5 Bout: 129 | -S3-Jerrad Trulson FH-----+
-S3-Jerrad Trulson FH-----+ M-Dec 17-8
(Fr) 18- 13 Bout: 34 | -S3-Jerrad Trulson FH-----+
-E2-Andre Swedberg HB-----+ M-Dec 13-2 | |
(Sr) 7- 7 Bout: 289 | -S2-Joe Arbizo SD-----+
-S2-Joe Arbizo SD-----+ Dec 4-2
(Sr) 48- 5 Bout: 35 | -S2-Joe Arbizo SD-----+
-E3-Lee Ellsworth SL-----+ M-Dec 11-3 | |
(Jr) 33- 14 Bout: 130 | -S2-Joe Arbizo SD-----+
-N4-Kyle Whitehair WL-----+ Fall 5:16
(SO) 17- 10 Bout: 36 | -W1-Brett Justus CA-----+
-W1-Brett Justus CA-----+ Fall 2:53 | |
(So) 33- 8 Bout: 384 | -S1-Frankie Villaescusa RR-----+
-S1-Frankie Villaescusa RR-----+ | | Champion
-S6-Patrick Sullivan ST-----+ Fall 2:49 | | Dec 2-5
(So) 10- 12 Bout: 131 | -S1-Frankie Villaescusa RR-----+
-N3-Cheabon Dawavendewa TC-----+ Fall 4:45 | |
(SR) 28- 8 Bout: 38 | -N3-Cheabon Dawavendewa TC-----+
-W2-Kyle Carlson PK-----+ Dec 10-5 | |
(Sr) 27- 13 Bout: 290 | -S1-Frankie Villaescusa RR-----+
-N2-Dustin Cornfield GN-----+ Fall 3:42
(SR) 37- 6 Bout: 39 | -N2-Dustin Cornfield GN-----+
-W3-Thomas Gallagher WK-----+ M-Dec 12-1 | |
(Jr) 18- 20 Bout: 132 | -S4-Thomas Gaeta CO-----+
-S4-Thomas Gaeta CO-----+ Dec 9-6
(So) 32- 9 Bout: 40 | -S4-Thomas Gaeta CO-----+
-E1-Billy Rova BR-----+ Dec 10-2 | |
(So) 14- 9 | |
-S5-Tyler Rogers WX-----+
Bout: 185 | -S5-Tyler Rogers WX-----+
-E2-Andre Swedberg HB-----+ Dec 4-2 Bout: 241 | -N2-Dustin Cornfield GN-----+
| | Dec 10-4 | |
-N2-Dustin Cornfield GN-----+ Bout: 317 | -N2-Dustin Cornfield GN-----+
-E3-Lee Ellsworth SL-----+ | | M-Dec 10-2
Bout: 186 | -E3-Lee Ellsworth SL-----+
-N4-Kyle Whitehair WL-----+ Fall 2:03 Bout: 242 | -E3-Lee Ellsworth SL-----+
| | M-Dec 21-8 | |
-N3-Cheabon Dawavendewa TC-----+
-S6-Patrick Sullivan ST-----+
Bout: 187 | -S6-Patrick Sullivan ST-----+
-W2-Kyle Carlson PK-----+ Dec 7-1 Bout: 243 | -S6-Patrick Sullivan ST-----+
| | Dec 6-0 | |
-W1-Brett Justus CA-----+ Bout: 318 | -N1-Ryan Salt MV-----+
-W3-Thomas Gallagher WK-----+ | | Dec 10-4
Bout: 188 | -E1-Billy Rova BR-----+ | |
-E1-Billy Rova BR-----+ Fall 2:55 Bout: 244 | -N1-Ryan Salt MV-----+
| | M-Dec 15-4 | | Bout: 346 | -S4-Thomas Gaeta CO-----+
-N1-Ryan Salt MV-----+ | | Dec 7-4
| |
-S4-Thomas Gaeta CO-----+
| |
-S3-Jerrad Trulson FH-----+
Bout: 382 | -S3-Jerrad Trulson FH-----+
-N1-Ryan Salt MV-----+ | | 5th Place
| | M-Dec 14-3
- Place Winners -
1st S1-Frankie Villaescusa RR (Sr) 41- 2
2nd S2-Joe Arbizo SD (Sr) 51- 6
5th S3-Jerrad Trulson FH (Fr) 21- 15
6th N1-Ryan Salt MV (JR) 34- 12

3rd S4-Thomas Gaeta CO (So) 36- 10
 4th N2-Dustin Cornfield GN (SR) 41- 8

Weight: 135

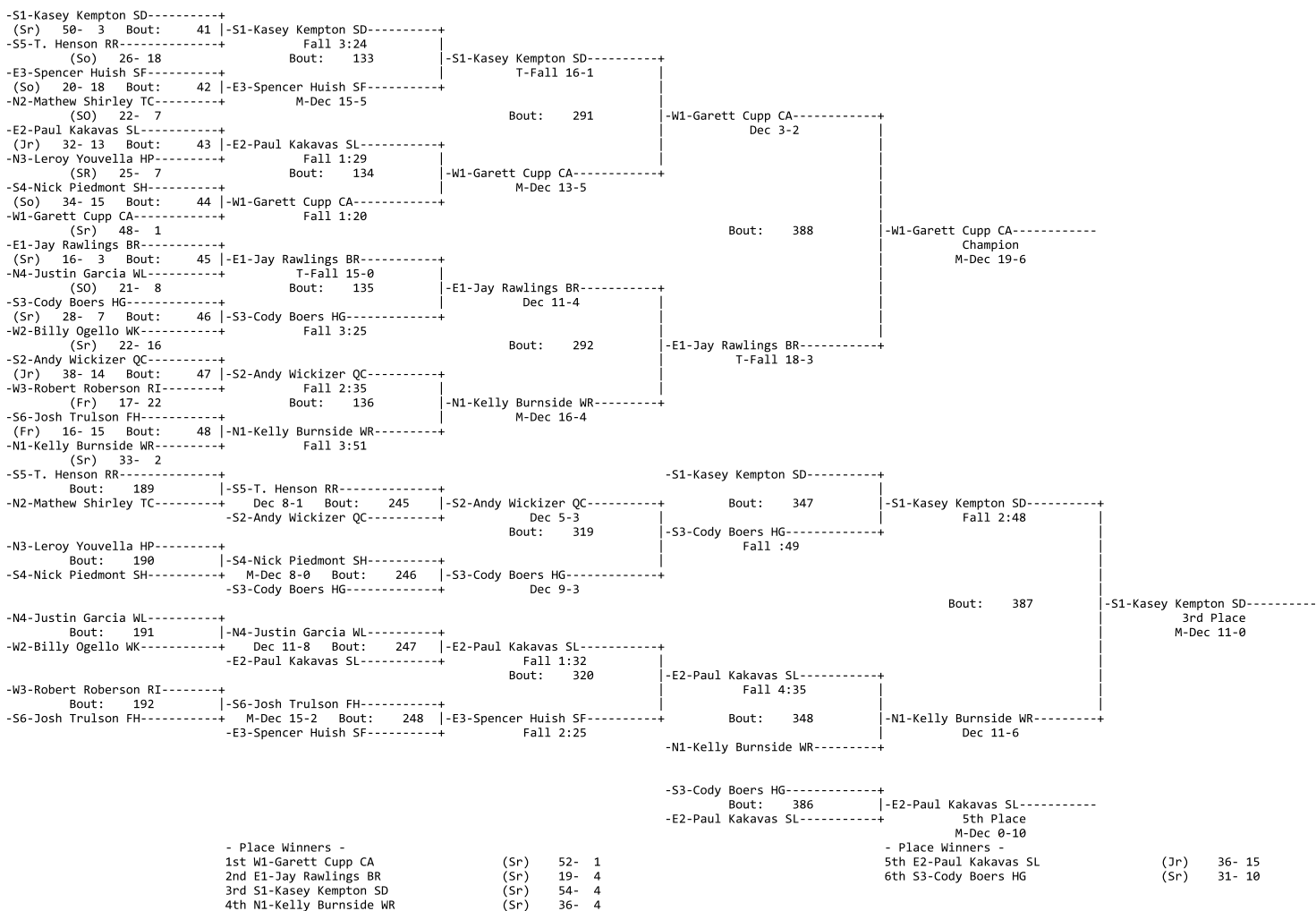

Weight: 140

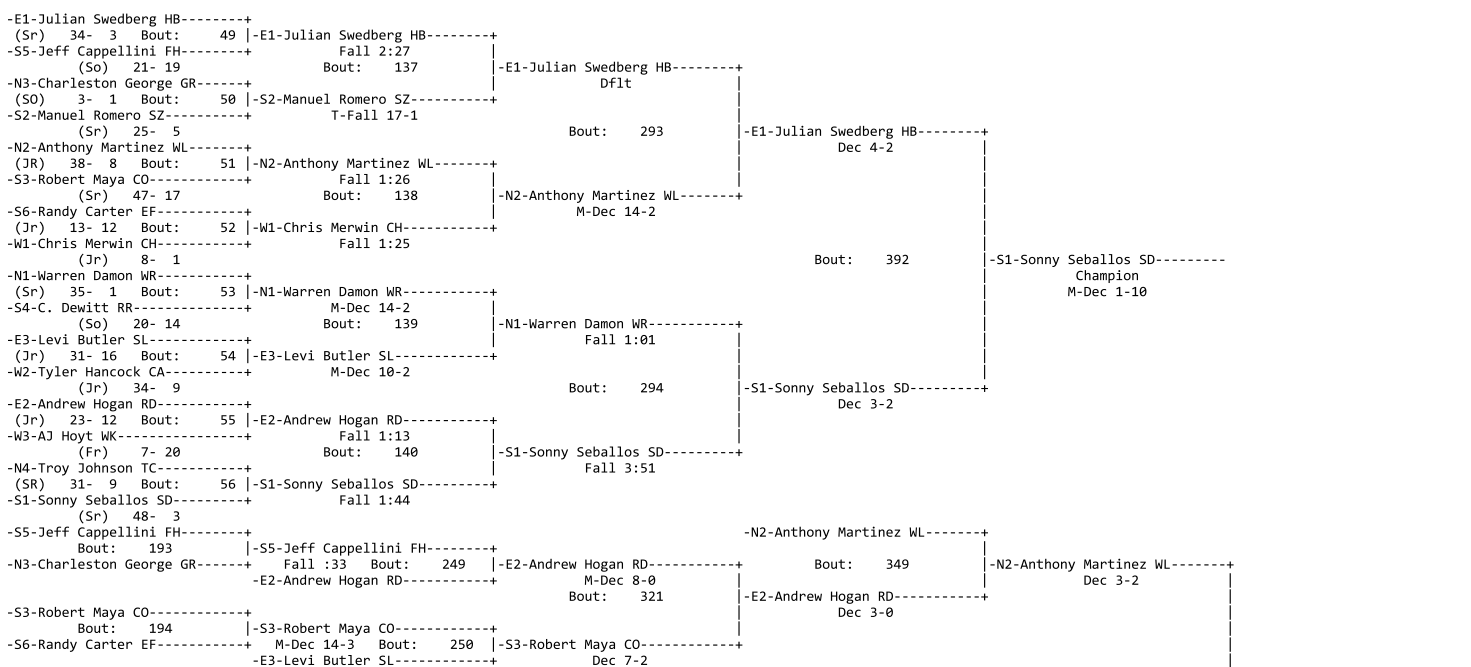

-S4-C. Dewitt RR-----+ Bout: 195		-W2-Tyler Hancock CA-----+ M-Dec 17-7 Bout: 251		-W2-Tyler Hancock CA-----+ Dec 7-6 Bout: 322		-W2-Tyler Hancock CA-----+ Fall 2:08		Bout: 391		-N1-Warren Damon WR-----+ 3rd Place Dec 3-7
-W2-Tyler Hancock CA-----+ -W1-Chris Merwin CH-----+ Bout: 196		-N4-Troy Johnson TC-----+ Dec 6-2 Bout: 252		-N4-Troy Johnson TC-----+ Dflt		Bout: 350		-N1-Warren Damon WR-----+ Dec 8-4		
-W3-AJ Hoyt WK-----+ Bout: 196		-N4-Troy Johnson TC-----+ Dec 6-2 Bout: 252		-N4-Troy Johnson TC-----+ Dflt		Bout: 350		-N1-Warren Damon WR-----+ Dec 8-4		
-N4-Troy Johnson TC-----+ -S2-Manuel Romero SZ-----+ Bout: 196		-N4-Troy Johnson TC-----+ Dec 6-2 Bout: 252		-N4-Troy Johnson TC-----+ Dflt		Bout: 350		-N1-Warren Damon WR-----+ Dec 8-4		
- Place Winners -										
1st S1-Sonny Seballos SD	(Sr)	52- 3								
2nd E1-Julian Swedberg HB	(Sr)	37- 4								
3rd N1-Warren Damon WR	(Sr)	39- 2								(Jr) 27- 14
4th N2-Anthony Martinez WL	(JR)	41- 10								(Jr) 37- 12

Weight: 145

-W1-Jacob Osorio WK-----+ (Jr) 24- 8 Bout: 57		-W1-Jacob Osorio WK-----+ M-Dec 14-4 Bout: 141		-E3-Steve Parkinson BR-----+ Dec 5-2		-S1-Gabriel Beach RR-----+ M-Dec 10-1		Bout: 295		
-S4-Jason Newton CO-----+ (So) 37- 28		-E3-Steve Parkinson BR-----+ Dec 5-2		-E3-Steve Parkinson BR-----+ Dec 5-2		-S1-Gabriel Beach RR-----+ M-Dec 10-1		Bout: 295		
-E3-Steve Parkinson BR-----+ (Fr) 19- 17 Bout: 58		-E3-Steve Parkinson BR-----+ Dec 5-2		-E3-Steve Parkinson BR-----+ Dec 5-2		-S1-Gabriel Beach RR-----+ M-Dec 10-1		Bout: 295		
-N2-Ricardo Harvey WR-----+ (So) 23- 13		-E3-Steve Parkinson BR-----+ Dec 5-2		-E3-Steve Parkinson BR-----+ Dec 5-2		-S1-Gabriel Beach RR-----+ M-Dec 10-1		Bout: 295		
-E2-Ryan Lague SL-----+ (Jr) 23- 9 Bout: 59		-E2-Ryan Lague SL-----+ Fall 1:09		-S1-Gabriel Beach RR-----+ M-Dec 13-1		-S1-Gabriel Beach RR-----+ M-Dec 10-1		Bout: 295		
-N3-Pete Begay WL-----+ (JR) 16- 11		-E2-Ryan Lague SL-----+ Fall 1:09		-S1-Gabriel Beach RR-----+ M-Dec 13-1		-S1-Gabriel Beach RR-----+ M-Dec 10-1		Bout: 295		
-S5-Cory Smith SH-----+ (Jr) 24- 18 Bout: 60		-E2-Ryan Lague SL-----+ Fall 1:09		-S1-Gabriel Beach RR-----+ M-Dec 13-1		-S1-Gabriel Beach RR-----+ M-Dec 10-1		Bout: 295		
-S1-Gabriel Beach RR-----+ (Sr) 24- 3		-E2-Ryan Lague SL-----+ Fall 1:09		-S1-Gabriel Beach RR-----+ M-Dec 13-1		-S1-Gabriel Beach RR-----+ M-Dec 10-1		Bout: 295		
-E1-Ben Kapp SF-----+ (Sr) 32- 7 Bout: 61		-E2-Ryan Lague SL-----+ Fall 1:09		-S1-Gabriel Beach RR-----+ M-Dec 13-1		-S1-Gabriel Beach RR-----+ M-Dec 10-1		Bout: 295		
-N4-Stanley Lomayestewa HP-----+ (SO) 14- 20		-E2-Ryan Lague SL-----+ Fall 1:09		-S1-Gabriel Beach RR-----+ M-Dec 13-1		-S1-Gabriel Beach RR-----+ M-Dec 10-1		Bout: 295		
-W3-Kevin Lucs PK-----+ (Fr) 7- 36 Bout: 62		-E2-Ryan Lague SL-----+ Fall 1:09		-S1-Gabriel Beach RR-----+ M-Dec 13-1		-S1-Gabriel Beach RR-----+ M-Dec 10-1		Bout: 295		
-S2-Jason Jurado SD-----+ (Sr) 48- 5		-E2-Ryan Lague SL-----+ Fall 1:09		-S1-Gabriel Beach RR-----+ M-Dec 13-1		-S1-Gabriel Beach RR-----+ M-Dec 10-1		Bout: 295		
-W2-Steven Glassey CA-----+ (Sr) 27- 9 Bout: 63		-E2-Ryan Lague SL-----+ Fall 1:09		-S1-Gabriel Beach RR-----+ M-Dec 13-1		-S1-Gabriel Beach RR-----+ M-Dec 10-1		Bout: 295		
-S3-Chris Esquivel EF-----+ (Sr) 35- 8		-E2-Ryan Lague SL-----+ Fall 1:09		-S1-Gabriel Beach RR-----+ M-Dec 13-1		-S1-Gabriel Beach RR-----+ M-Dec 10-1		Bout: 295		
-S6-Drew Musacchio QC-----+ (Jr) 23- 30 Bout: 64		-E2-Ryan Lague SL-----+ Fall 1:09		-S1-Gabriel Beach RR-----+ M-Dec 13-1		-S1-Gabriel Beach RR-----+ M-Dec 10-1		Bout: 295		
-N1-Craig Johnson PN-----+ (JR) 27- 5		-E2-Ryan Lague SL-----+ Fall 1:09		-S1-Gabriel Beach RR-----+ M-Dec 13-1		-S1-Gabriel Beach RR-----+ M-Dec 10-1		Bout: 295		
-S4-Jason Newton CO-----+ Bout: 197		-E2-Ryan Lague SL-----+ Fall 1:09		-S1-Gabriel Beach RR-----+ M-Dec 13-1		-S1-Gabriel Beach RR-----+ M-Dec 10-1		Bout: 295		
-N2-Ricardo Harvey WR-----+ Dec 10-6 Bout: 253		-E2-Ryan Lague SL-----+ Fall 1:09		-S1-Gabriel Beach RR-----+ M-Dec 13-1		-S1-Gabriel Beach RR-----+ M-Dec 10-1		Bout: 295		
-N3-Pete Begay WL-----+ Bout: 198		-E2-Ryan Lague SL-----+ Fall 1:09		-S1-Gabriel Beach RR-----+ M-Dec 13-1		-S1-Gabriel Beach RR-----+ M-Dec 10-1		Bout: 295		
-S5-Cory Smith SH-----+ Dec 15-8 Bout: 254		-E2-Ryan Lague SL-----+ Fall 1:09		-S1-Gabriel Beach RR-----+ M-Dec 13-1		-S1-Gabriel Beach RR-----+ M-Dec 10-1		Bout: 295		
-N4-Stanley Lomayestewa HP-----+ Bout: 199		-E2-Ryan Lague SL-----+ Fall 1:09		-S1-Gabriel Beach RR-----+ M-Dec 13-1		-S1-Gabriel Beach RR-----+ M-Dec 10-1		Bout: 295		
-W3-Kevin Lucs PK-----+ Fall 4:01 Bout: 255		-E2-Ryan Lague SL-----+ Fall 1:09		-S1-Gabriel Beach RR-----+ M-Dec 13-1		-S1-Gabriel Beach RR-----+ M-Dec 10-1		Bout: 295		
-W2-Steven Glassey CA-----+ Bout: 200		-E2-Ryan Lague SL-----+ Fall 1:09		-S1-Gabriel Beach RR-----+ M-Dec 13-1		-S1-Gabriel Beach RR-----+ M-Dec 10-1		Bout: 295		
-S6-Drew Musacchio QC-----+ Fall 1:50 Bout: 256		-E2-Ryan Lague SL-----+ Fall 1:09		-S1-Gabriel Beach RR-----+ M-Dec 13-1		-S1-Gabriel Beach RR-----+ M-Dec 10-1		Bout: 295		
-W1-Jacob Osorio WK-----+ Bout: 197		-E2-Ryan Lague SL-----+ Fall 1:09		-S1-Gabriel Beach RR-----+ M-Dec 13-1		-S1-Gabriel Beach RR-----+ M-Dec 10-1		Bout: 295		
- Place Winners -										
1st S1-Gabriel Beach RR	(Sr)	28- 3								
2nd S2-Jason Jurado SD	(Sr)	51- 6								
3rd E1-Ben Kapp SF	(Sr)	37- 8								
4th E2-Ryan Lague SL	(Jr)	27- 11								

Weight: 152

-E1-Sean Holladay SL-----+ (Jr) 45- 4 Bout: 65		-E1-Sean Holladay SL-----+ M-Dec 12-0 Bout: 145		-S3-Kyle Day SH-----+ Dec 5-1		-W1-Aaron Hancock CA-----+ Fall 3:44		Bout: 297		
-S5-Andrew Roper HG-----+ (Jr) 18- 10		-E1-Sean Holladay SL-----+ M-Dec 12-0		-S3-Kyle Day SH-----+ Dec 5-1		-W1-Aaron Hancock CA-----+ Fall 3:44		Bout: 297		
-S3-Kyle Day SH-----+ (Jr) 38- 11 Bout: 66		-E1-Sean Holladay SL-----+ M-Dec 12-0		-S3-Kyle Day SH-----+ Dec 5-1		-W1-Aaron Hancock CA-----+ Fall 3:44		Bout: 297		
-N2-Chad Gillis MV-----+ (JR) 28- 17		-E1-Sean Holladay SL-----+ M-Dec 12-0		-S3-Kyle Day SH-----+ Dec 5-1		-W1-Aaron Hancock CA-----+ Fall 3:44		Bout: 297		
-S2-M. Ortega RR-----+ (Sr) 36- 5 Bout: 67		-E1-Sean Holladay SL-----+ M-Dec 12-0		-S3-Kyle Day SH-----+ Dec 5-1		-W1-Aaron Hancock CA-----+ Fall 3:44		Bout: 297		
-N3-Francis Collins WR-----+ (Sr) 37- 16		-E1-Sean Holladay SL-----+ M-Dec 12-0		-S3-Kyle Day SH-----+ Dec 5-1		-W1-Aaron Hancock CA-----+ Fall 3:44		Bout: 297		
-S6-Anthony Campillo EF-----+ (Sr) 21- 21 Bout: 68		-E1-Sean Holladay SL-----+ M-Dec 12-0		-S3-Kyle Day SH-----+ Dec 5-1		-W1-Aaron Hancock CA-----+ Fall 3:44		Bout: 297		
-W1-Aaron Hancock CA-----+ (Sr) 44- 0		-E1-Sean Holladay SL-----+ M-Dec 12-0		-S3-Kyle Day SH-----+ Dec 5-1		-W1-Aaron Hancock CA-----+ Fall 3:44		Bout: 297		
-S1-Justin Gaethje SD-----+ (So) 53- 0 Bout: 69		-E1-Sean Holladay SL-----+ M-Dec 12-0		-S3-Kyle Day SH-----+ Dec 5-1		-W1-Aaron Hancock CA-----+ Fall 3:44		Bout: 297		
-N4-Kirk Tsoisie GR-----+ (JR) 2- 2		-E1-Sean Holladay SL-----+ M-Dec 12-0		-S3-Kyle Day SH-----+ Dec 5-1		-W1-Aaron Hancock CA-----+ Fall 3:44		Bout: 297		
-E3-Cody Zoellner SF-----+ Bout: 147		-E1-Sean Holladay SL-----+ M-Dec 12-0		-S3-Kyle Day SH-----+ Dec 5-1		-W1-Aaron Hancock CA-----+ Fall 3:44		Bout: 297		
- Place Winners -										
5th S3-Kyle Day SH	(Sr)	38- 10								
6th E3-Steve Parkinson BR	(Fr)	21- 20								

(So) 10- 12 Bout: 70 -W2-Nick Uden PK-----+ -W2-Nick Uden PK-----+ Fall 3:00 (Jr) 2- 4 Bout: 298	-S1-Justin Gaethje SD-----+ Fall 5:00	
-E2-Jared Yazzie HB-----+ (So) 10- 13 Bout: 71 -E2-Jared Yazzie HB-----+ -W3-Sean Qualey RI-----+ Fall 3:47 (So) 18- 22 Bout: 148	-S4-Roberto Villalpando QC-----+ M-Dec 11-3	
-S4-Roberto Villalpando QC-----+ (Jr) 42- 18 Bout: 72 -S4-Roberto Villalpando QC-----+ -N1-John Gonzales WL-----+ Dec 11-6 (FR) 29- 9		
-S5-Andrew Roper HG-----+ Bout: 201 -S5-Andrew Roper HG-----+ -N2-Chad Gillis MV-----+ M-Dec 8-0 Bout: 257 -S5-Andrew Roper HG-----+ -E2-Jared Yazzie HB-----+ Dec 8-3 Bout: 325	-S3-Kyle Day SH-----+ Bout: 353 -S3-Kyle Day SH-----+ M-Dec 8-0	
-N3-Francis Collins WR-----+ Bout: 202 -N3-Francis Collins WR-----+ -S6-Anthony Campillo EF-----+ M-Dec 18-5 Bout: 258 -W2-Nick Uden PK-----+ -W2-Nick Uden PK-----+ Dec 8-6	-S5-Andrew Roper HG-----+ Fall 4:35	
-N4-Kirk Tsosie GR-----+ Bout: 203 -N4-Kirk Tsosie GR-----+ -E3-Cody Zoellner SF-----+ Fall 2:05 Bout: 259 -S2-M. Ortega RR-----+ -S2-M. Ortega RR-----+ T-Fall 17-2 Bout: 326	-E1-Sean Holladay SL-----+ Dec 4-3	
-W3-Sean Qualey RI-----+ Bout: 204 -N1-John Gonzales WL-----+ -N1-John Gonzales WL-----+ Dec 7-4 Bout: 260 -E1-Sean Holladay SL-----+ -E1-Sean Holladay SL-----+ Fall 2:49	-E1-Sean Holladay SL-----+ M-Dec 11-3	
	-S4-Roberto Villalpando QC-----+	
	-S5-Andrew Roper HG-----+ Bout: 398 -S4-Roberto Villalpando QC-----+ -S4-Roberto Villalpando QC-----+ 5th Place Dec 1-2	
- Place Winners -	- Place Winners -	
1st W1-Aaron Hancock CA (Sr) 48- 0	5th S4-Roberto Villalpando QC (Jr) 45- 20	
2nd S1-Justin Gaethje SD (So) 56- 1	6th S5-Andrew Roper HG (Jr) 21- 13	
3rd E1-Sean Holladay SL (Jr) 50- 5		
4th S3-Kyle Day SH (Jr) 41- 13		

Weight: 160

-N1-Cody Nez PN-----+ (SR) 22- 2 Bout: 73 -N1-Cody Nez PN-----+ -S5-Travis Hunt WX-----+ Fall 2:50 (Jr) 23- 11 Bout: 149	-N1-Cody Nez PN-----+ Dec 7-6	
-E3-Garet Flake SF-----+ (Jr) 31- 8 Bout: 74 -S2-Trevor Miller SH-----+ -S2-Trevor Miller SH-----+ M-Dec 13-1	Bout: 299	
-E2-AJ Bales SL-----+ (So) 34- 10 Bout: 75 -E2-AJ Bales SL-----+ -S3-Kyle Lebtich HG-----+ T-Fall 17-2 (Jr) 27- 5 Bout: 150	-W1-Jacinto Diaz CA-----+ Dec 12-6	
-N4-Kyle Whitney GN-----+ (SO) 3- 7 Bout: 76 -W1-Jacinto Diaz CA-----+ -W1-Jacinto Diaz CA-----+ Fall :28 (Sr) 46- 2	Bout: 404	-N2-Johnnie Teller TC-----+ Champion Fall 5:56
-E1-Jeremy Bench BR-----+ (Sr) 26- 8 Bout: 77 -S4-John Paul Perales SZ-----+ -S4-John Paul Perales SZ-----+ Dec 6-0 (So) 25- 19 Bout: 151	-S4-John Paul Perales SZ-----+ T-Fall 22-5	
-N3-Myron Brady MV-----+ (JR) 25- 21 Bout: 78 -N3-Myron Brady MV-----+ -W2-Woody Lotts PK-----+ Fall 1:53 (Sr) 17- 9	Bout: 300	-N2-Johnnie Teller TC-----+ Fall 1:33
-N2-Johnnie Teller TC-----+ (SR) 37- 3 Bout: 79 -N2-Johnnie Teller TC-----+ -W3-Johnathan Donnelly RI-----+ Fall :44 (Jr) 8- 13 Bout: 152	-N2-Johnnie Teller TC-----+ Dec 7-6	
-S6-Zach Doekson GL-----+ (Sr) 36- 19 Bout: 80 -S1-Michael Moore SD-----+ -S1-Michael Moore SD-----+ Fall 5:51 (Sr) 51- 2		
-S5-Travis Hunt WX-----+ Bout: 205 -E3-Garet Flake SF-----+ -E3-Garet Flake SF-----+ Fall 2:13 Bout: 261 -S1-Michael Moore SD-----+ -S1-Michael Moore SD-----+ Fall 4:51 Bout: 327	-N1-Cody Nez PN-----+ Bout: 355 -S1-Michael Moore SD-----+ Dec 6-3	
-S3-Kyle Lebtich HG-----+ Bout: 206 -S3-Kyle Lebtich HG-----+ -N4-Kyle Whitney GN-----+ Fall 4:03 Bout: 262 -S3-Kyle Lebtich HG-----+ -N3-Myron Brady MV-----+ Dec 5-2	-S1-Michael Moore SD-----+ Fall 3:34	
-E1-Jeremy Bench BR-----+ Bout: 207 -E1-Jeremy Bench BR-----+ -W2-Woody Lotts PK-----+ Dec 6-3 Bout: 263 -E2-AJ Bales SL-----+ -E2-AJ Bales SL-----+ Dq Bout: 328	Bout: 403	-S1-Michael Moore SD-----+ 3rd Place M-Dec 10-1
-W3-Johnathan Donnelly RI-----+ Bout: 208 -S6-Zach Doekson GL-----+ -S6-Zach Doekson GL-----+ Fall 1:32 Bout: 264 -S2-Trevor Miller SH-----+ -S2-Trevor Miller SH-----+ Dec 9-3	-S2-Trevor Miller SH-----+ M-Dec 8-0	
	-S4-John Paul Perales SZ-----+	
	-N1-Cody Nez PN-----+ Bout: 402 -N1-Cody Nez PN-----+ -S4-John Paul Perales SZ-----+ 5th Place M-Dec 15-3	
- Place Winners -	- Place Winners -	
1st N2-Johnnie Teller TC (SR) 41- 3	5th N1-Cody Nez PN (SR) 25- 4	
2nd W1-Jacinto Diaz CA (Sr) 49- 3	6th S4-John Paul Perales SZ (So) 27- 22	
3rd S1-Michael Moore SD (Sr) 56- 3		
4th S2-Trevor Miller SH (Sr) 44- 10		

Weight: 171

-S1-Travis Depper SH-----+

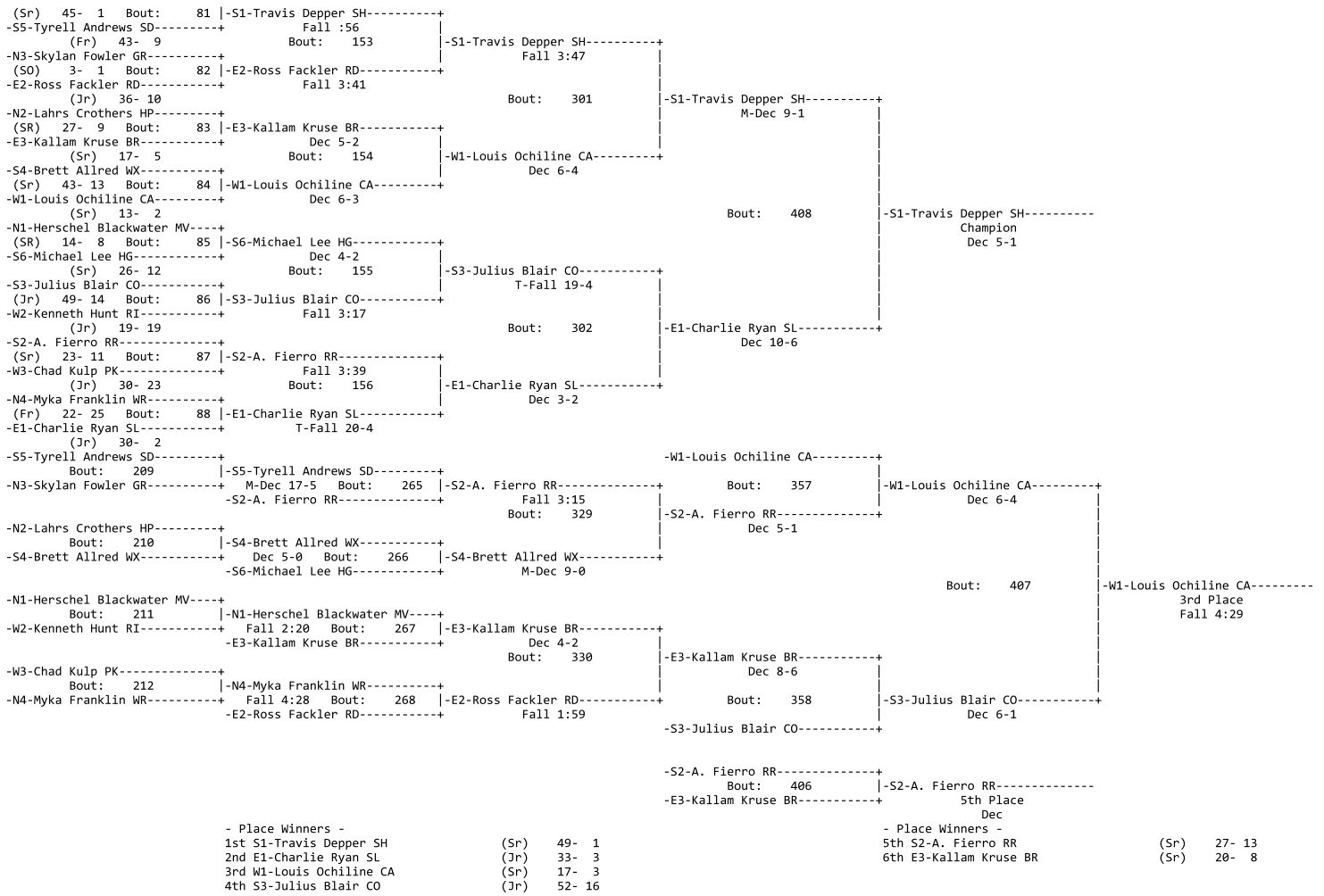

Weight: 189

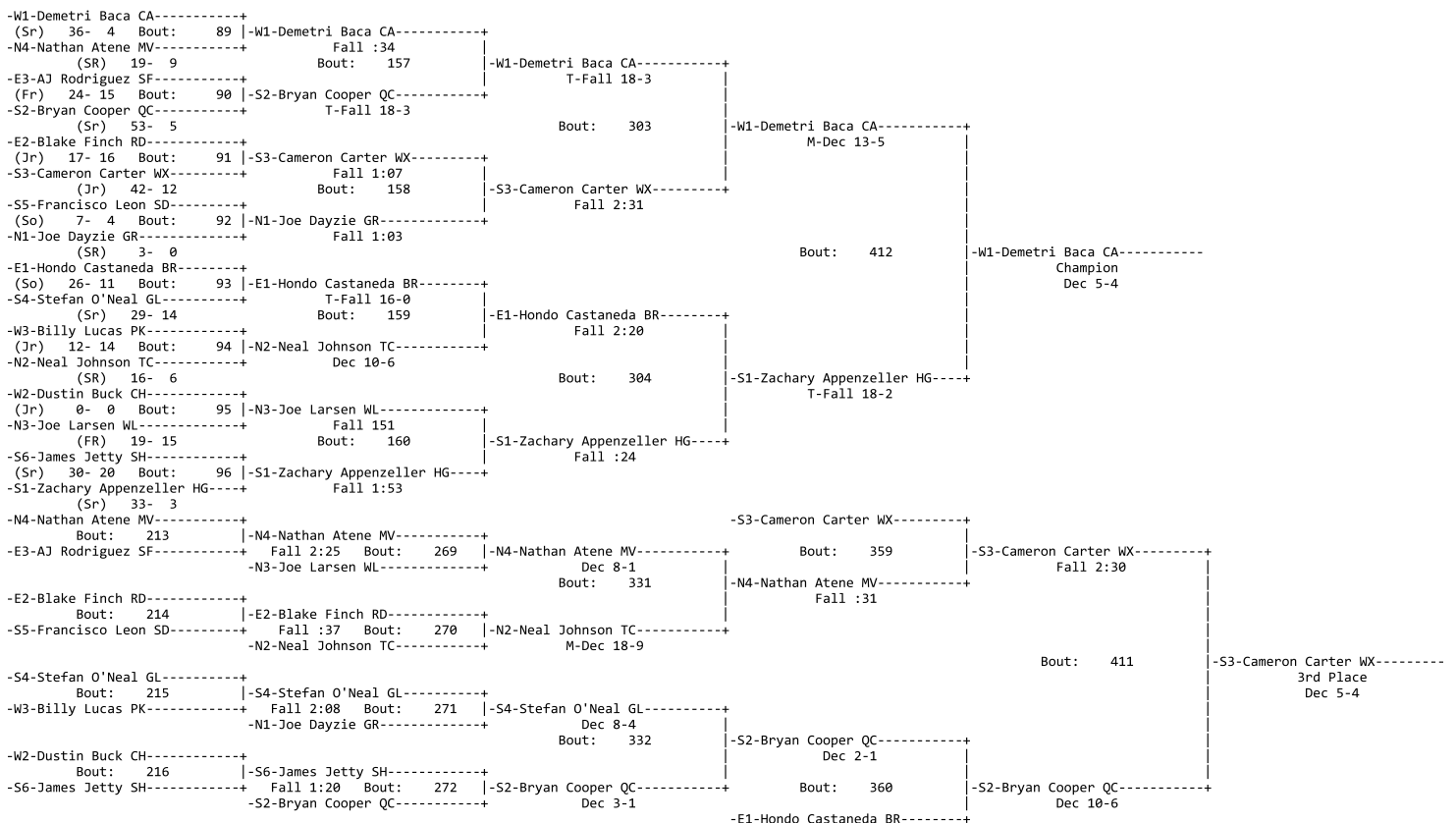

-N4-Nathan Atene MV-----+
 Bout: 410 | -E1-Hondo Castaneda BR-----+
 -E1-Hondo Castaneda BR-----+
 5th Place
 Fall 5:47

- Place Winners -
 1st W1-Demetri Baca CA
 2nd S1-Zachary Appenzeller HG
 3rd S3-Cameron Carter WX
 4th S2-Bryan Cooper QC

(Sr) 40- 4
 (Sr) 36- 4
 (Jr) 46- 13
 (Sr) 57- 7

- Place Winners -
 5th E1-Hondo Castaneda BR (So) 29- 13
 6th N4-Nathan Atene MV (SR) 22- 12

Weight: 215

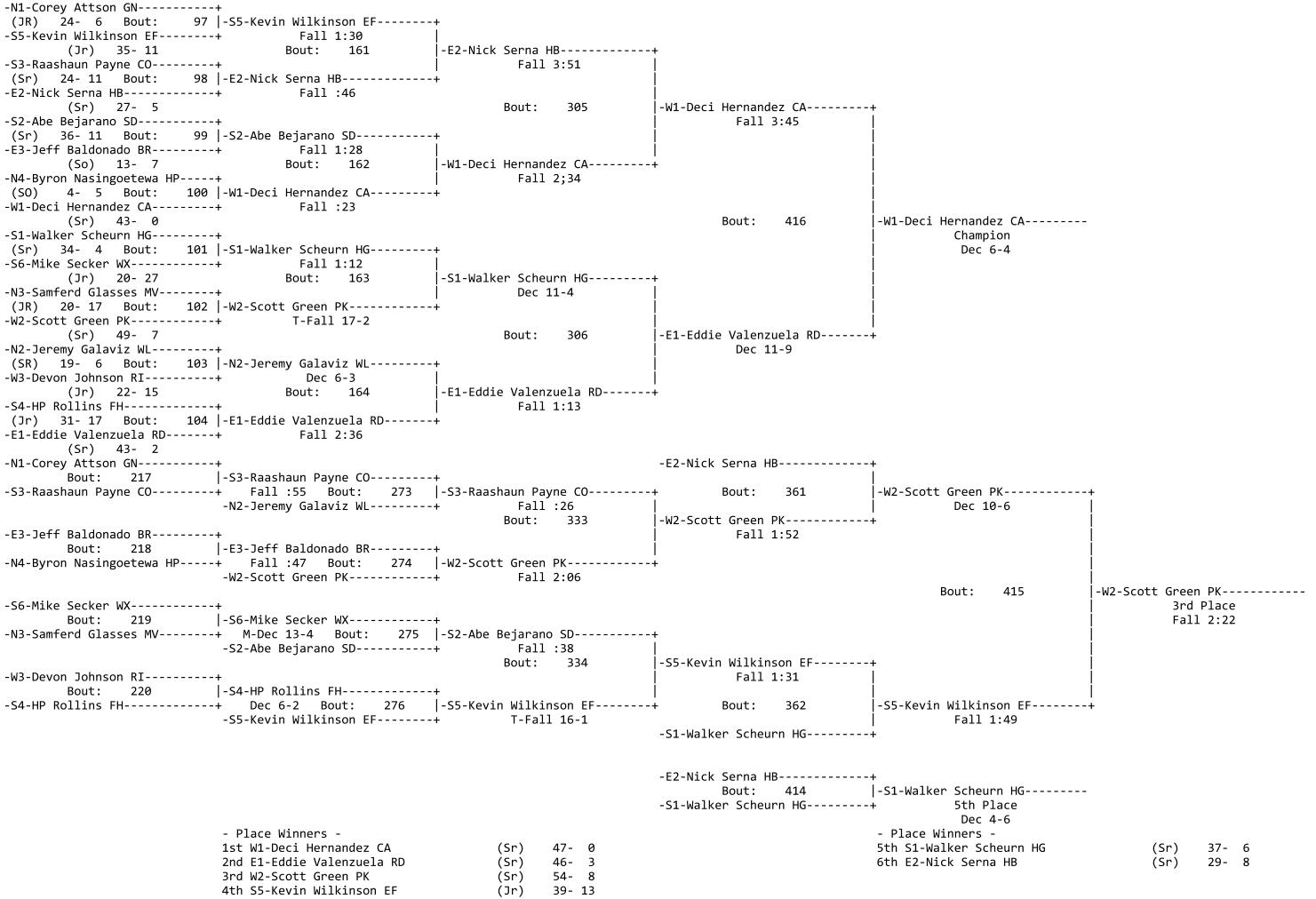

Weight: 275

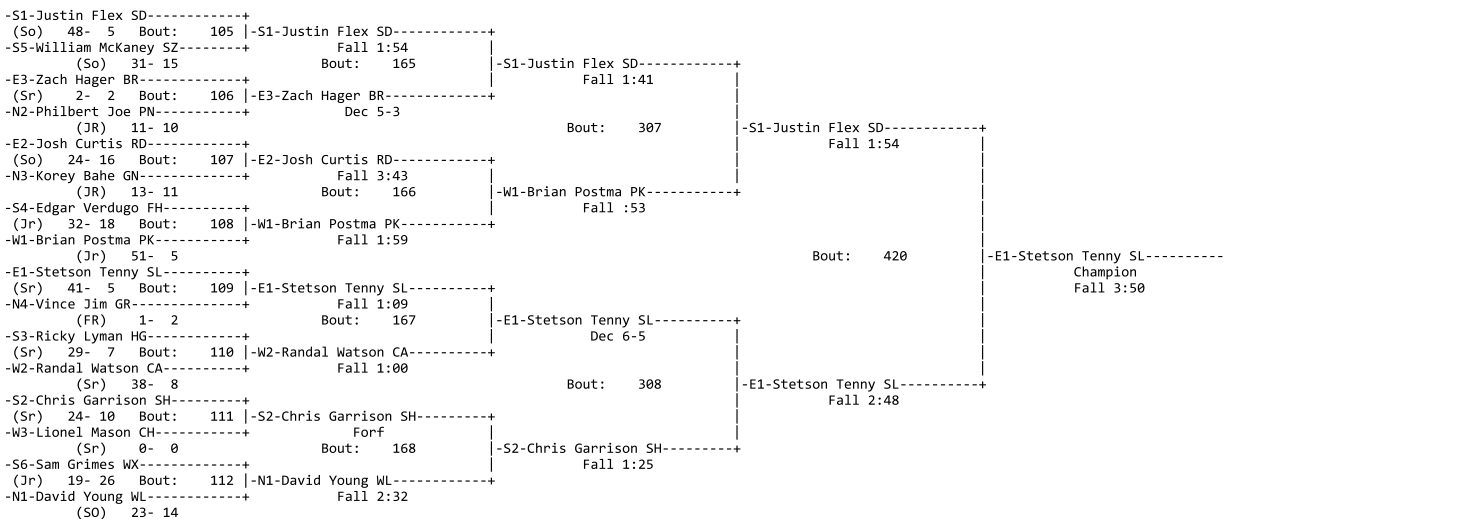

Brackets

-S5-William McKaney SZ-----+ Bout: 221	-S5-William McKaney SZ-----+ Dec 5-3 Bout: 277	-N1-David Young WL-----+ Dec 2-1 Bout: 335	-W1-Brian Postma PK-----+ Bout: 363	-W1-Brian Postma PK-----+ Dec 7-6	
-N2-Philbert Joe PN-----+ -N1-David Young WL-----+			-W2-Randal Watson CA-----+ Fall 3:21		
-N3-Korey Bahe GN-----+ Bout: 222	-S4-Edgar Verdugo FH-----+ Fall 1:53 Bout: 278	-W2-Randal Watson CA-----+ Fall 2:06			
-S4-Edgar Verdugo FH-----+ -W2-Randal Watson CA-----+				Bout: 419	-S3-Ricky Lyman HG-----+ 3rd Place Dec 3-4
-N4-Vince Jim GR-----+ Bout: 223	-S3-Ricky Lyman HG-----+ Fall :43 Bout: 279	-S3-Ricky Lyman HG-----+ Fall 1:19 Bout: 336	-S3-Ricky Lyman HG-----+ Dec 2-0		
-S3-Ricky Lyman HG-----+ -E2-Josh Curtis RD-----+			-S3-Ricky Lyman HG-----+ Bout: 364		
-W3-Lionel Mason CH-----+ Bout: 224	-S6-Sam Grimes WX-----+ Forf Bout: 280	-E3-Zach Hager BR-----+ Fall 2:02	-S2-Chris Garrison SH-----+ -W2-Randal Watson CA-----+ Bout: 418	-W2-Randal Watson CA-----+ 5th Place Dq	
-S6-Sam Grimes WX-----+ -E3-Zach Hager BR-----+					
					- Place Winners -
					1st E1-Stetson Tenny SL (Sr) 45- 5
					2nd S1-Justin Flex SD (So) 51- 6
					3rd S3-Ricky Lyman HG (Sr) 34- 8
					4th W1-Brian Postma PK (Jr) 54- 7
					- Place Winners -
					5th W2-Randal Watson CA (Sr) 42- 10
					6th S2-Chris Garrison SH (Sr) 26- 13

Preferred Educational Software

9585 Woodgate Lane
 Byron IL 61010
 Phone: (888) 959-2016
 e-mail: cotterk@pes-sports.com

(c) 2001 - All rights reserved

2004-2005 4A State Wrestling Tournament

WT 103 YR	NAME	SCHOOL	W - L	Fall Score	WT 145 YR	NAME	SCHOOL	W - L	Fall Score
Champ Sr	Lopez, Johnny	Sunnyside	38 - 4	5 - 3	Champ Sr	Crandall, Joey	Ironwood Rdg.	28 - 12	10 - 9
Second Jr	Garcia, Matt	Desert View	33 - 11		Second Jr	David Cluff	Payson	46 - 6	
Third Jr	Nick Saenz	Thunderbird	43 - 6		Third	John Coker	Agua Fria	39 - 7	
Fourth Fr	Miles, Adam	Cienega	33 - 8		Fourth Sr	Brandon Piense	Moon Valley	44 - 9	
Fifth Jr	Vila, Jesus	Nogales	31 - 10		Fifth Sr	Crowe, Brad	Catalina Foot.	26 - 4	
Sixth So	Gorney, Ryan	Ironwood Rdg.	28 - 13		Sixth Sr	Morales, Johnny	Pueblo	45 - 11	
WT 112 YR	NAME	SCHOOL	W - L	Fall Score	WT 152 YR	NAME	SCHOOL	W - L	Fall Score
Champ Jr	Gabe Gomez	Tempe	33 - 4	15 - 4	Champ Sr	Lopez, Matt	Sunnyside	34 - 2	14 - 6
Second So	David Leaphart	Thunderbird	35 - 9		Second Sr	Chris Gruetzemacher	Thunderbird	36 - 6	
Third Fr	Garza, Paul	Sunnyside	31 - 5		Third Sr	Anthony Stickler	Page	22 - 6	
Fourth So	Jeremy Mazon	Prescott	28 - 7		Fourth Sr	Tom Kirby	Desert Ridge	41 - 4	
Fifth So	Islas, David	Pueblo	43 - 10		Fifth So	Santana Quintero	Tempe	23 - 7	
Sixth So	Clyde Yellowhair	Chinle	41 - 11		Sixth Sr	Cowell, Orion	Palo Verde	16 - 8	
WT 119 YR	NAME	SCHOOL	W - L	Fall Score	WT 160 YR	NAME	SCHOOL	W - L	Fall Score
Champ So	Tyler Chang	Mingus	44 - 5	5 - 3	Champ Sr	Vasquez, Paul	Pueblo	46 - 2	12 - 8
Second Jr	Steve Aragon	Moon Valley	43 - 7	Overtime	Second Sr	Contento, Lance	Catalina Foot.	35 - 6	
Third So	Zack Mainez	Thunderbird	44 - 7		Third Sr	Andre Harris	Apache Jct.	44 - 3	
Fourth Jr	Tyler Goodman	Payson	40 - 10		Fourth Jr	Reedy, Ben	Ironwood Rdg.	20 - 7	
Fifth Sr	Larry Sanchez	Tempe	34 - 9		Fifth	Wes Fimbrez	Dysart	39 - 9	
Sixth Sr	Clark, Nash	Ironwood Rdg.	29 - 10		Sixth Jr	Reese Roder	Mingus	43 - 9	
WT 125 YR	NAME	SCHOOL	W - L	Fall Score	WT 171 YR	NAME	SCHOOL	W - L	Fall Score
Champ Sr	Gallick, Nick	Sunnyside	31 - 0	10 - 4	Champ Sr	Nate Lee	Payson	53 - 0	18 - 7
Second Jr	Rod Loehr	Mingus	45 - 6		Second Sr	Braun Stapley	Sinagua	37 - 7	
Third So	Ricky Abril	Thunderbird	38 - 7		Third	Dylon Maki	Buckeye	32 - 9	
Fourth Sr	Kyle Greenhalgh	Tempe	34 - 11		Fourth Sr	Beninati, Eric	Cienega	30 - 9	
Fifth Jr	Matt Long	Moon Valley	23 - 11		Fifth So	Frank De La Garza	Sunnyslope	31 - 4	
Sixth So	Corey Cross	Centennial	35 - 12		Sixth So	Justin Busto	Greenway	23 - 14	
WT 130 YR	NAME	SCHOOL	W - L	Fall Score	WT 189 YR	NAME	SCHOOL	W - L	Fall Score
Champ Sr	Jose Ontiveros	Flagstaff	43 - 0	3 - 1	Champ Sr	Thor Moen	Coconino	36 - 3	4 - 3
Second Sr	Gasca, Ruben	Sunnyside	30 - 5		Second Sr	Quintana, Ruben	Sunnyside	36 - 4	Dble Overtime
Third So	Travis Wokasch	Mingus	44 - 8		Third Sr	JJ Ambrose	Mohave	46 - 8	
Fourth Sr	Brad Fulton	Greenway	46 - 4		Fourth So	Mack Surrell	Thunderbird	42 - 5	
Fifth Jr	Xavier Ramirez	Apache Jct.	46 - 9		Fifth Sr	Robert McGee	Sunnyslope	43 - 7	
Sixth Jr	Isaac Selin	Cortez	34 - 12		Sixth Sr	Edgar Guerra	Independence	28 - 8	

WT 135 YR	NAME	SCHOOL	W - L	Fall Score	WT 215 YR	NAME	SCHOOL	W - L	Fall Score
Champ Jr	Torres, Rene	Sunnyside	30 - 2	13 - 4	Champ Sr	Dexter Davis	Thunderbird	43 - 3	10 - 5
Second Sr	Johnny Alvarado	Flagstaff	36 - 3		Second Jr	House, Travis	Cholla	34 - 2	
Third Sr	Zach Saenz	Moon Valley	40 - 12		Third Jr	Smith, Joe	Amphi	20 - 5	
Fourth Sr	Tellez, Tyler	Marana	39 - 6		Fourth So	J. J. Sanchez	Independence	41 - 4	
Fifth Jr	Lee Perez	Payson	46 - 8		Fifth Jr	Ben Garbett	Cortez	33 - 10	
Sixth Sr	Alan Paris	Mohave	47 - 8		Sixth Jr	Donald Engler	Payson	14 - 8	
WT 140 YR	NAME	SCHOOL	W - L	Fall Score	WT HWT YR	NAME	SCHOOL	W - L	Fall Score
Champ So	DeBerry, Kyle	Sunnyside	32 - 4	10 - 6	Champ Sr	James Paisano	Mingus	43 - 7	3:02 -
Second Sr	Brian Long	Moon Valley	38 - 4		Second Jr	Matt Guyer	Mohave	44 - 6	
Third Jr	Luis Silva	Mingus	41 - 1		Third Sr	Andrew Wanner	Sunnyslope	42 - 6	
Fourth Sr	Lovio, Mike	Pueblo	46 - 6		Fourth Jr	Diamond Johnson	Independence	36 - 9	
Fifth Jr	Baker, Mitch	Marana	37 - 10		Fifth Sr	Kyle Kissack	Prescott	31 - 11	
Sixth Sr	Ryan Mulcahy	Coronado	27 - 7		Sixth Sr	Sal Muna	Coronado	14 - 4	

2004-2005 4A State Wrestling Tournament

Place	School	Points	Place	School	Points
1	Sunnyside	235.5	28	Nogales	30
2	Thunderbird	180	29	Sinagua	29
3	Mingus	142	30	Cholla	27.5
4	Payson	117	31	Douglas	25.5
5	Moon Valley	110	32	Desert View	25
6	Pueblo	101.5	33	Apollo	24.5
7	Tempe	98	34	McClintock	23
8	Mohave	91	35	Cactus	22
9	Ironwood Rdg	83	36	Basha	21
10	Sunnyslope	72.5	36	Page	21
11	Apache Jct.	71.5	38	Palo Verde	18

12	Prescott	63	39	Bradshaw Mtn	17.5
13	Flagstaff	62.5	40	Chinle	14
14	Independence	56.5	41	Saguaro	13.5
15	Buckeye	55	42	Santa Rita	13
15	Desert Ridge	55	43	Lake Havasu	10
17	Dysart	46.5	44	Pinnacle	8
18	Greenway	46	45	Chaparral	7
19	Coconino	45.5	45	Notre Dame	7
19	Cortez	45.5	47	Millennium	6
21	Catalina Foot.	44	48	La Joya	5
21	Marana	44	49	Cactus Shad.	4
23	Centennial	40.5	49	San Luis	4
24	Amphi	40	49	Washington	4
25	Cienega	39.5	49	Willow Canyon	4
26	Coronado	35	53	Sabino	3
27	Agua Fria	33			

Phoenix, AZ

State 5A Wrestling

Team Scores

February 5, 11-12, 2005

1.	Highland	183.00
2.	Red Mountain	157.00
3.	Mountain View Mesa	156.50
4.	Mesa	129.50
5.	Deer Valley	111.00
6.	Horizon	109.00
7.	Cibola	107.00
8.	Cesar Chavez	99.50
9.	Barry Goldwater	98.50
10.	Marcos De Niza	93.50
11.	Corona Del Sol	92.00
12.	Westwood	85.00
13.	Peoria	83.00
14.	North	78.50
15.	Desert Vista	71.50
16.	Gilbert	69.50
17.	Mountain View Marana	67.50
18.	Hamilton	65.00
19.	Maryvale	57.00
20.	Salpointe	52.00
21.	Kofa	49.50
22.	Sunrise Mountain	49.00
23.	Westview	45.00
24.	Mesquite	43.00
25.	Paradise Valley	37.00
26.	Sandra Day O'Connor	35.50
27.	Dobson	32.00
28.	Mountain Pointe	28.00
29.	Buena	25.00
30.	Central	24.00
31.	Flowing Wells	23.50
32.	Carl Hayden	19.00
32. (tie)	Sahuaro	19.00
32. (tie)	Yuma	19.00
35.	Canyon Del Oro	18.00
36.	Chandler	17.00
37.	Alhambra	16.00
37. (tie)	Ironwood	16.00
39.	South Mountain	15.00
40.	Brophy	12.00
40. (tie)	Camelback	12.00
42.	Trevor Browne	9.00
43.	Casa Grande	6.00
44.	North Canyon	5.50
45.	Kingman	5.00

45. (tie)	Mountain Ridge	5.00
47.	Tucson	4.00
48.	Tolleson	2.00
49.	Desert Mountain	0.00
49. (tie)	Skyline	0.00

Tourney Contact

00000
e-mail:

Publisher
Preferred Educational Software
9585 Woodgate Lane
Byron IL 61010
Phone: (888) 959-2016
e-mail: cotterk@pes-sports.com

© 2001 - All rights reserved

State 5A Wrestling Phoenix, AZ February 5, 11-12, 2005

Weight: 103

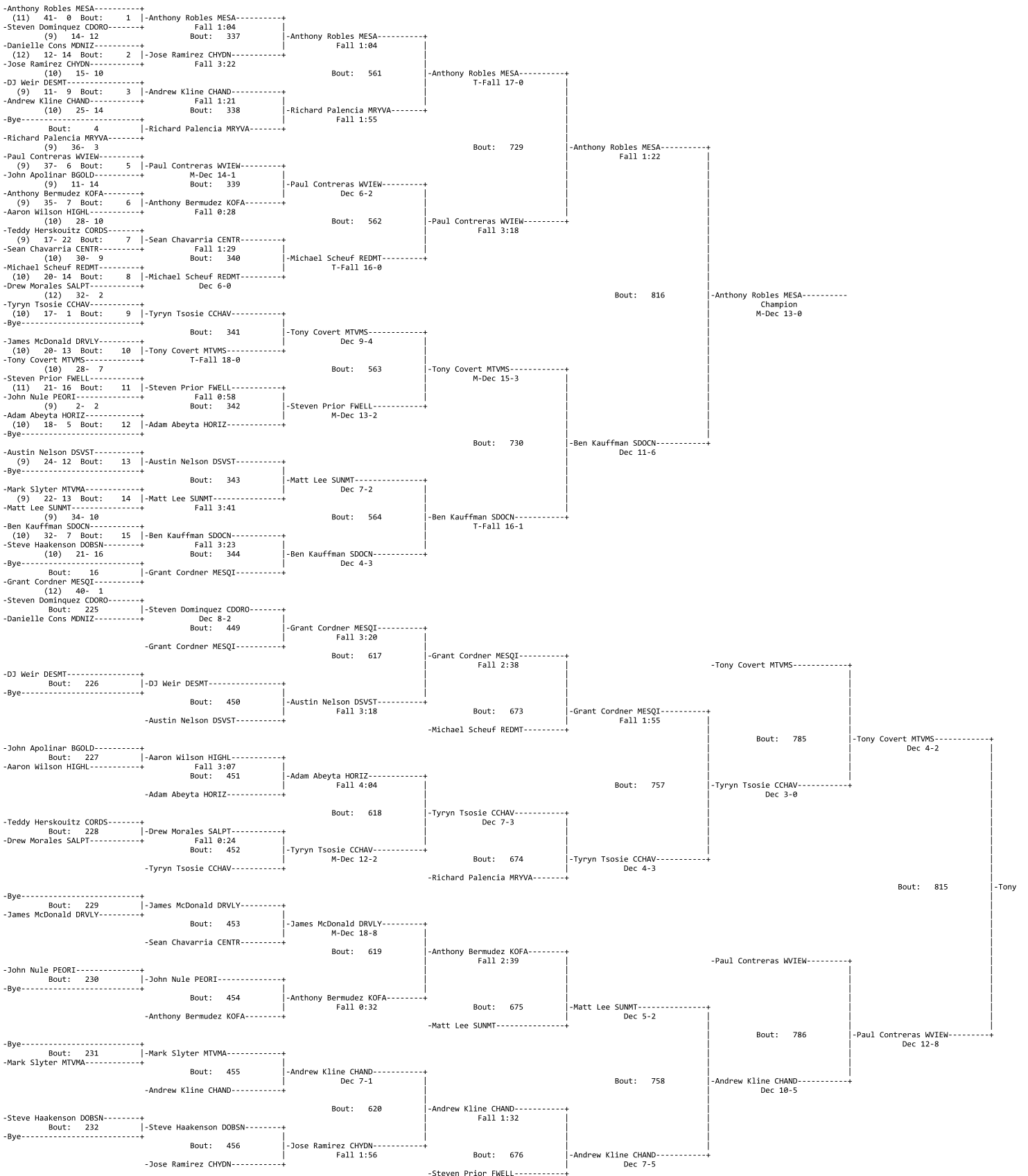

-Tyrn Tsoie CCHAV-----+
 Bout: 814 | -Tyrn Tsoie CCHAV-----
 -Andrew Kline CHAND-----+
 5th Place
 T-Fall 18-3

- Place Winners -
 1st Anthony Robles MESA (11) 46- 0
 2nd Ben Kauffman SDOCN (10) 36- 8
 3rd Tony Covert MTVMS (10) 33- 8
 4th Paul Contreras WVIEW (9) 41- 8

- Place Winners -
 5th Tyrn Tsoie CCHAV (10) 22- 3
 6th Andrew Kline CHAND (10) 30- 17

Weight: 112

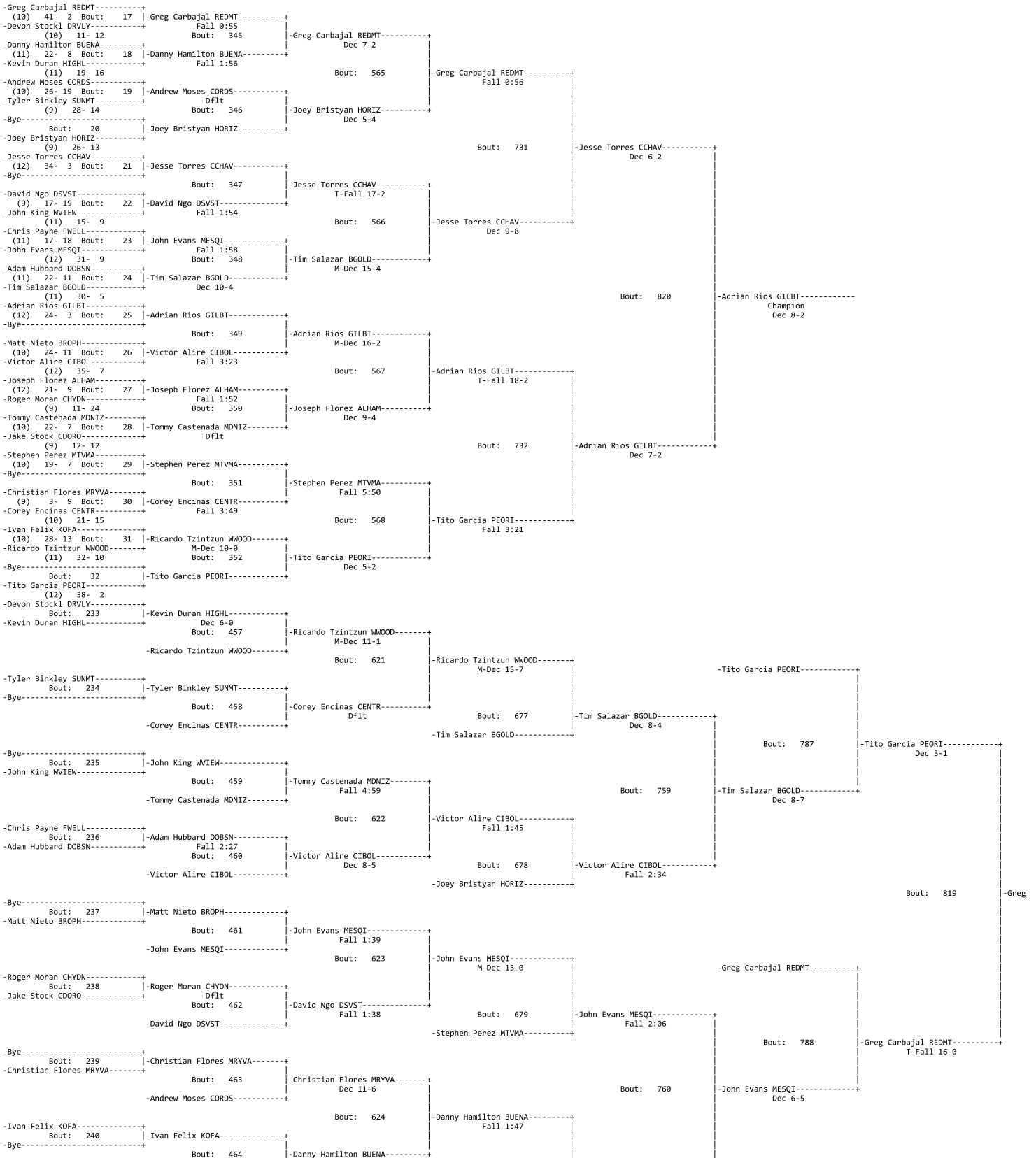

-Danny Hamilton BUENA-----+ Bout: 680	M-Dec 12-3	-Danny Hamilton BUENA-----+ Dec 7-5	
-Joseph Florez ALHAM-----+ Bout: 818		-Tim Salazar BGOLD-----+ Bout: 818	-Tim Salazar BGOLD-----+ 5th Place T-Fall 20-3
		-John Evans MESQI-----+ T-Fall 20-3	
- Place Winners -		- Place Winners -	
1st Adrian Rios GILBT (12) 28- 3		5th Tim Salazar BGOLD (11) 35- 7	
2nd Jesse Torres CCHAV (12) 37- 4		6th John Evans MESQI (12) 36- 12	
3rd Greg Carbajal REDMT (10) 46- 3			
4th Tito Garcia PEORI (12) 41- 4			

Weight: 119

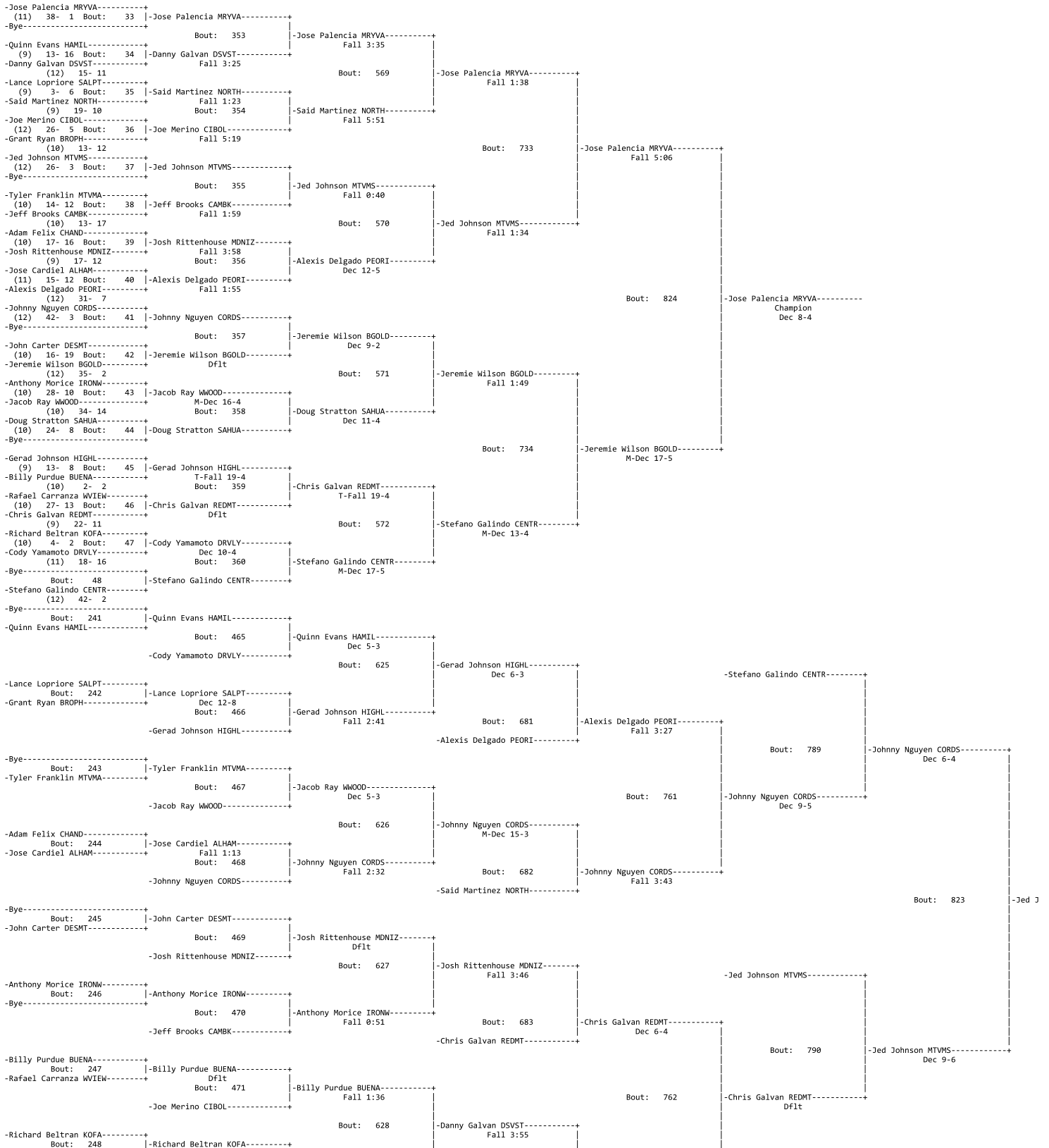

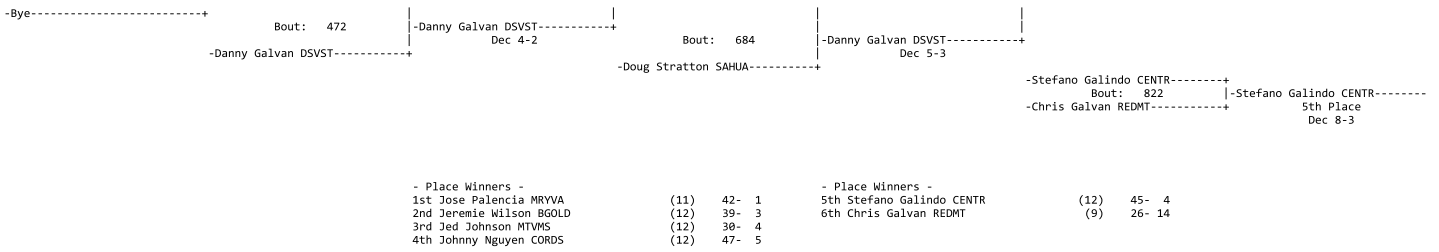

Weight: 125

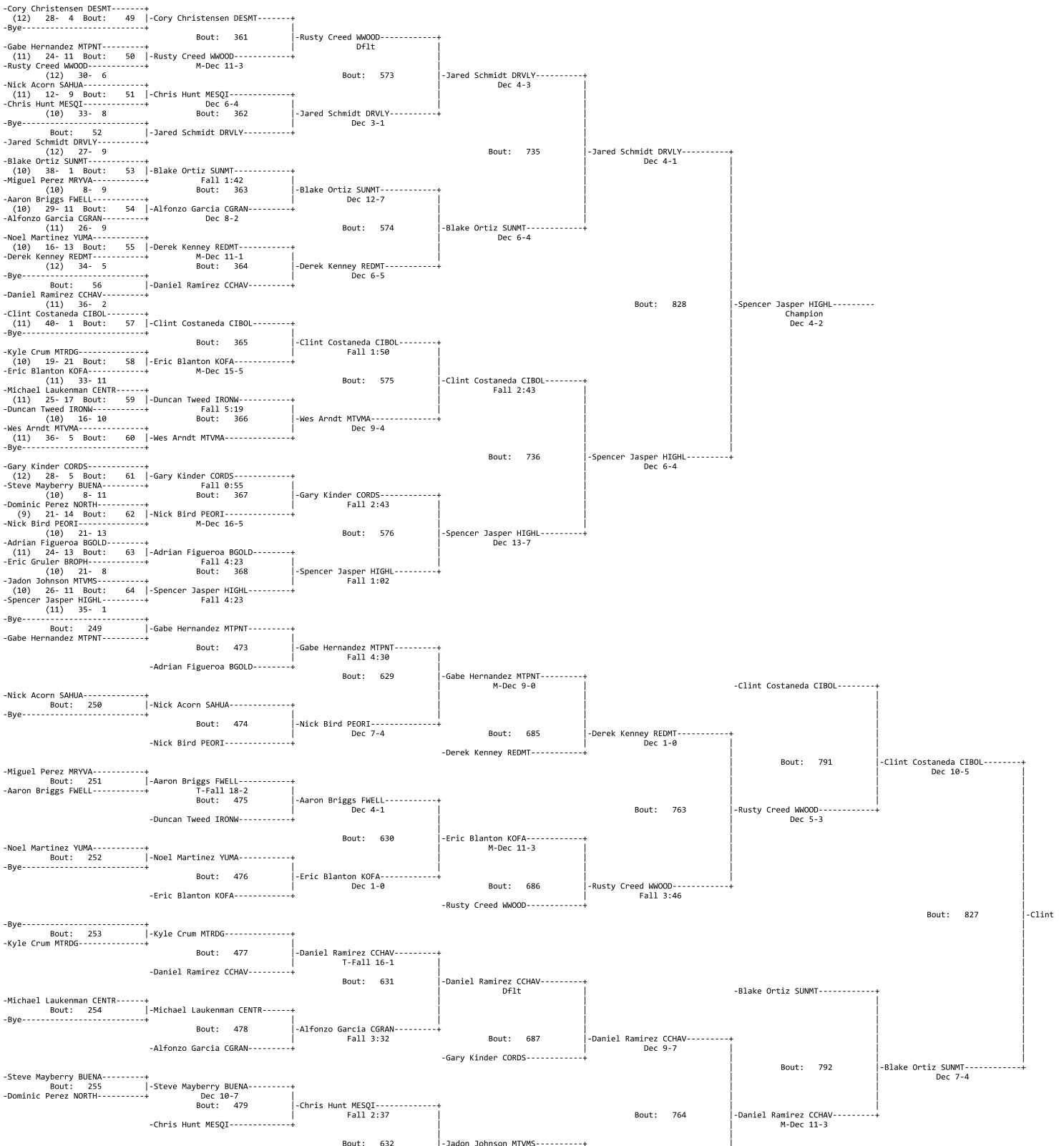

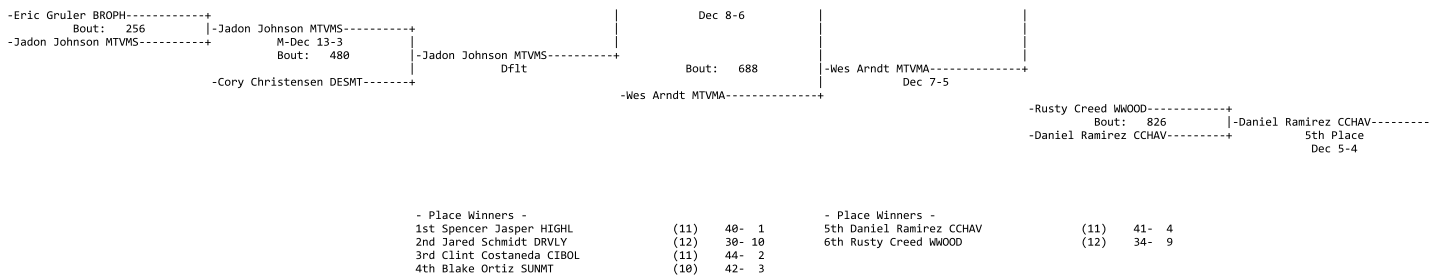

Weight: 130

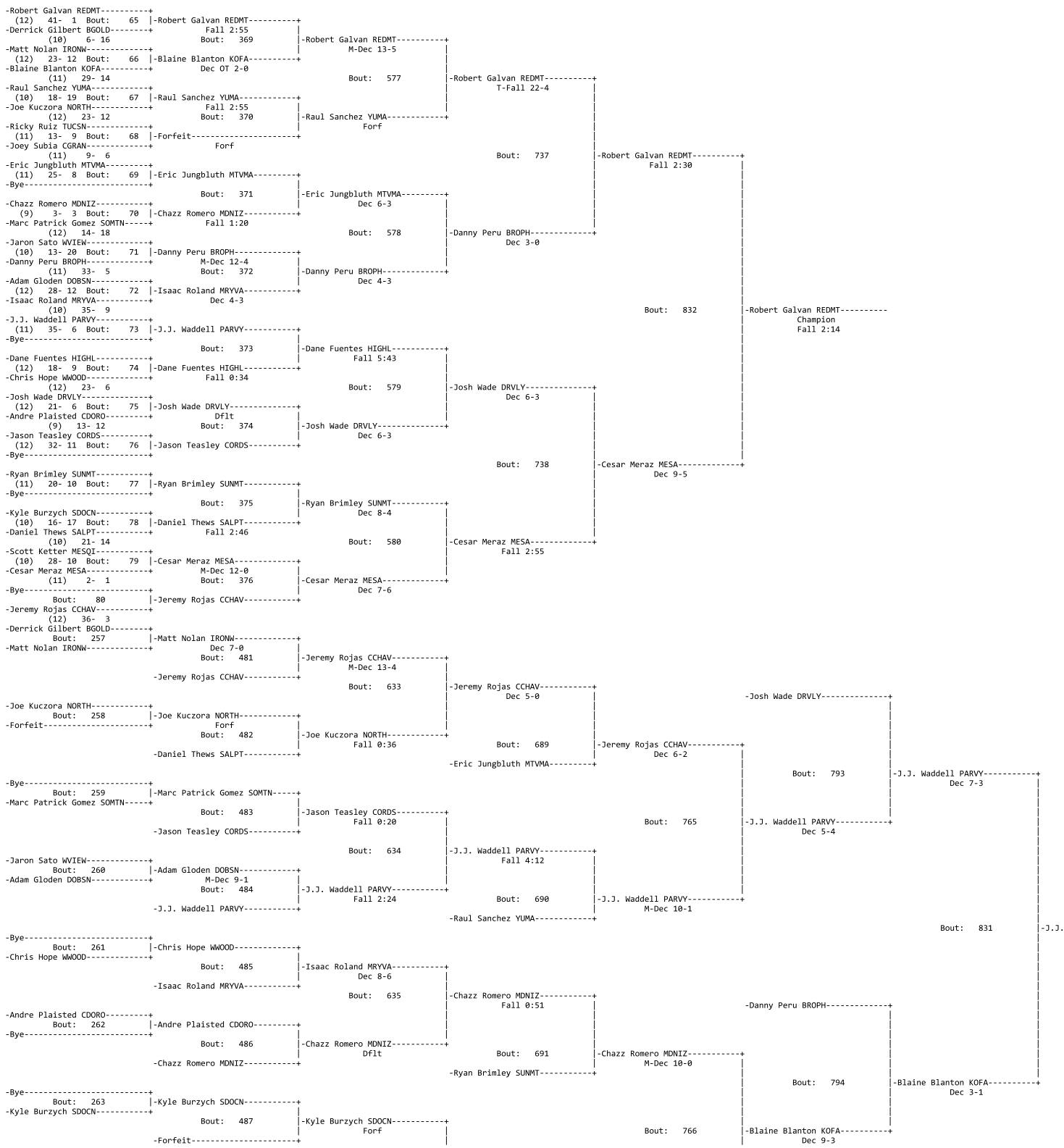

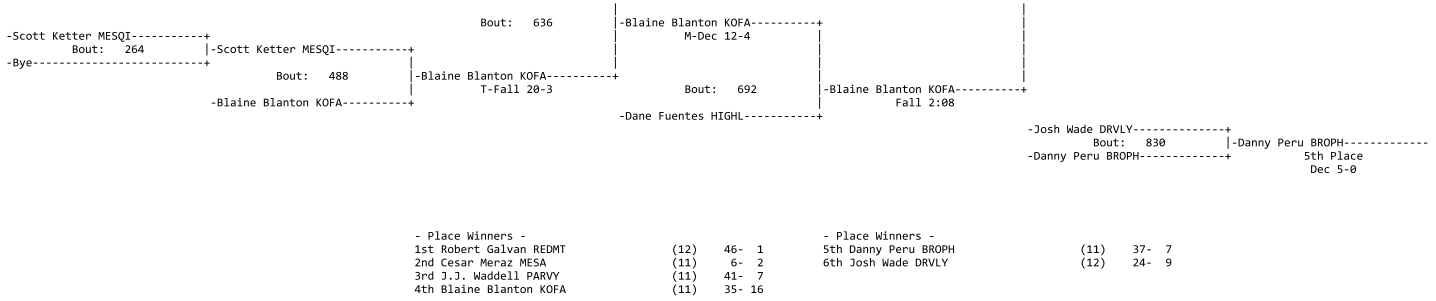

Weight: 135

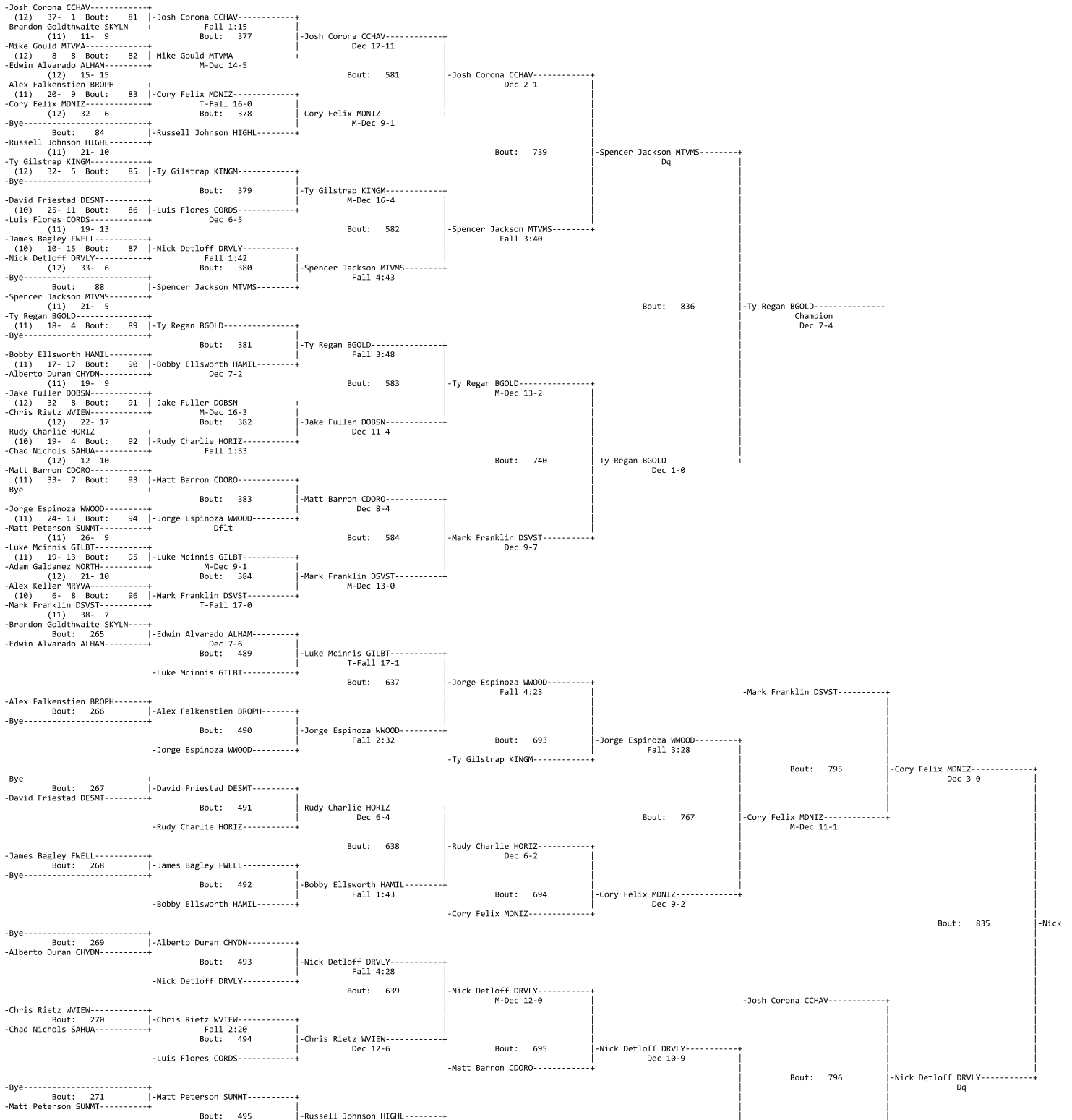

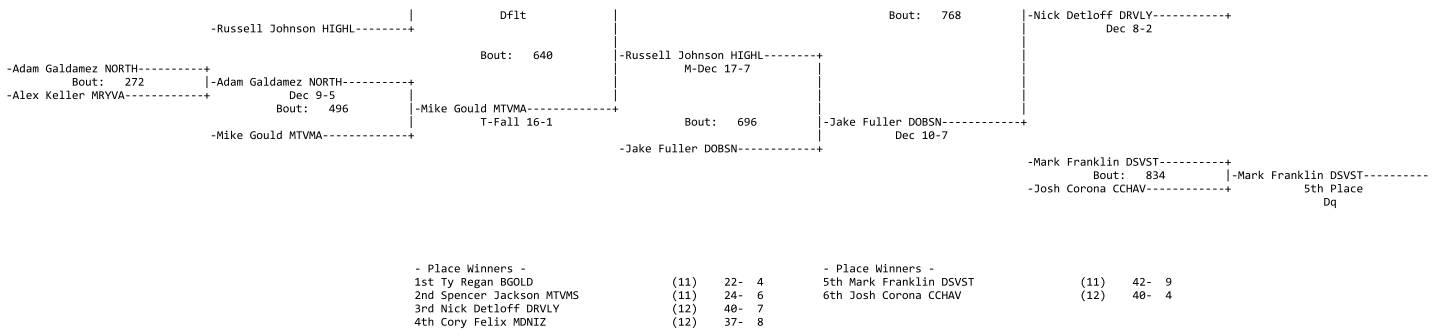

Weight: 140

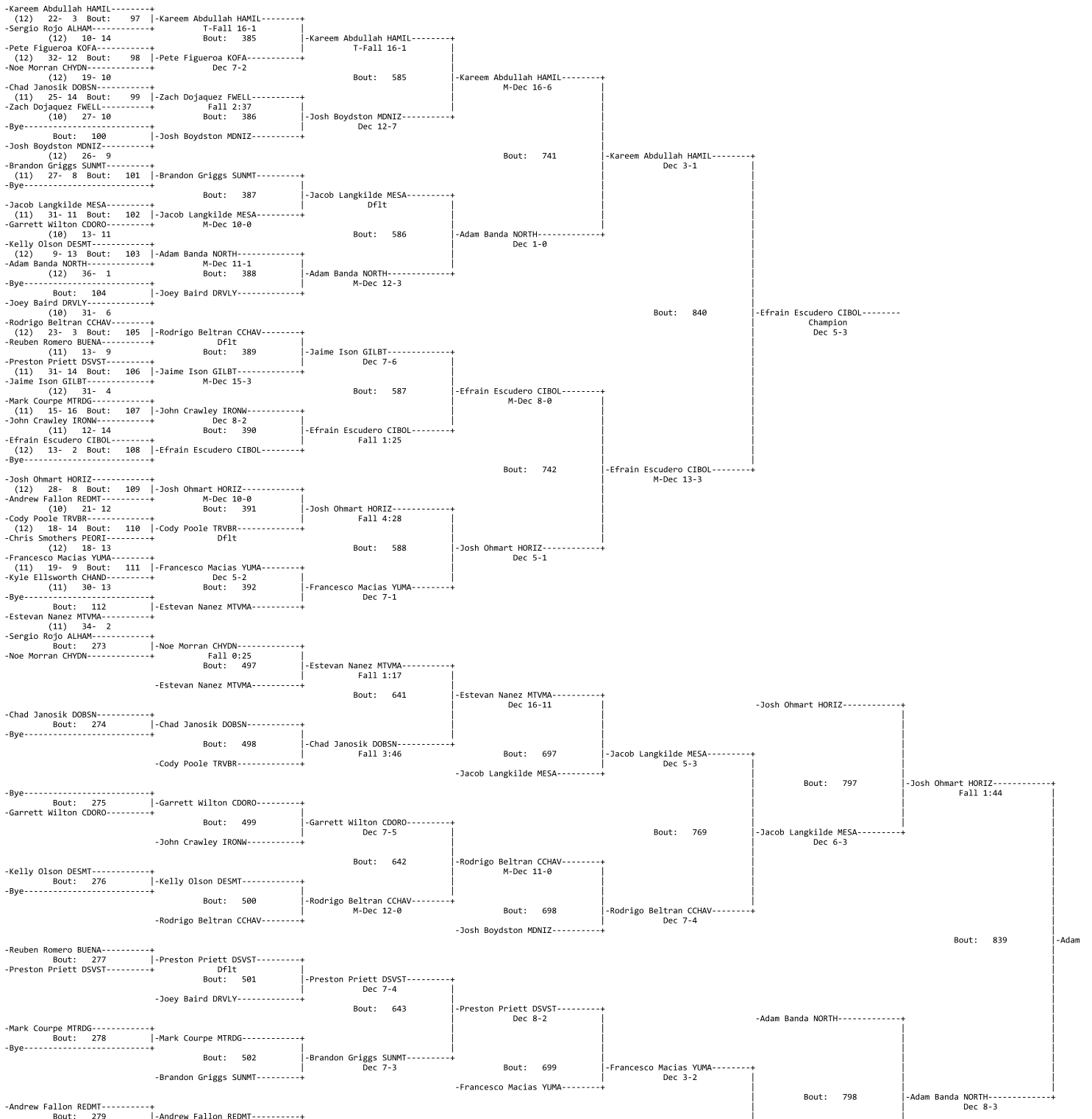

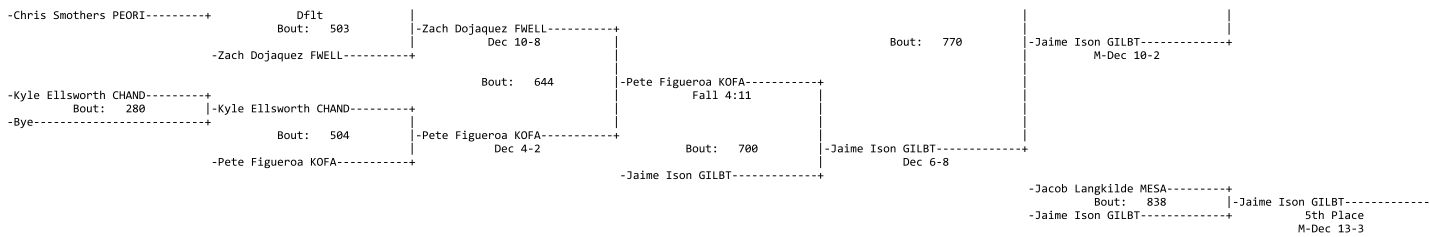

- Place Winners -	(12) 17- 2	- Place Winners -	(12) 36- 6
1st Efrain Escudero CIBOL	(12) 26- 4	5th Jaime Ison GILBT	(11) 35- 14
2nd Kareem Abdullah HAMIL	(12) 41- 2	6th Jacob Langkilde MESA	
3rd Adam Banda NORTH	(12) 32- 10		
4th Josh Ohmart HORIZ			

Weight: 145

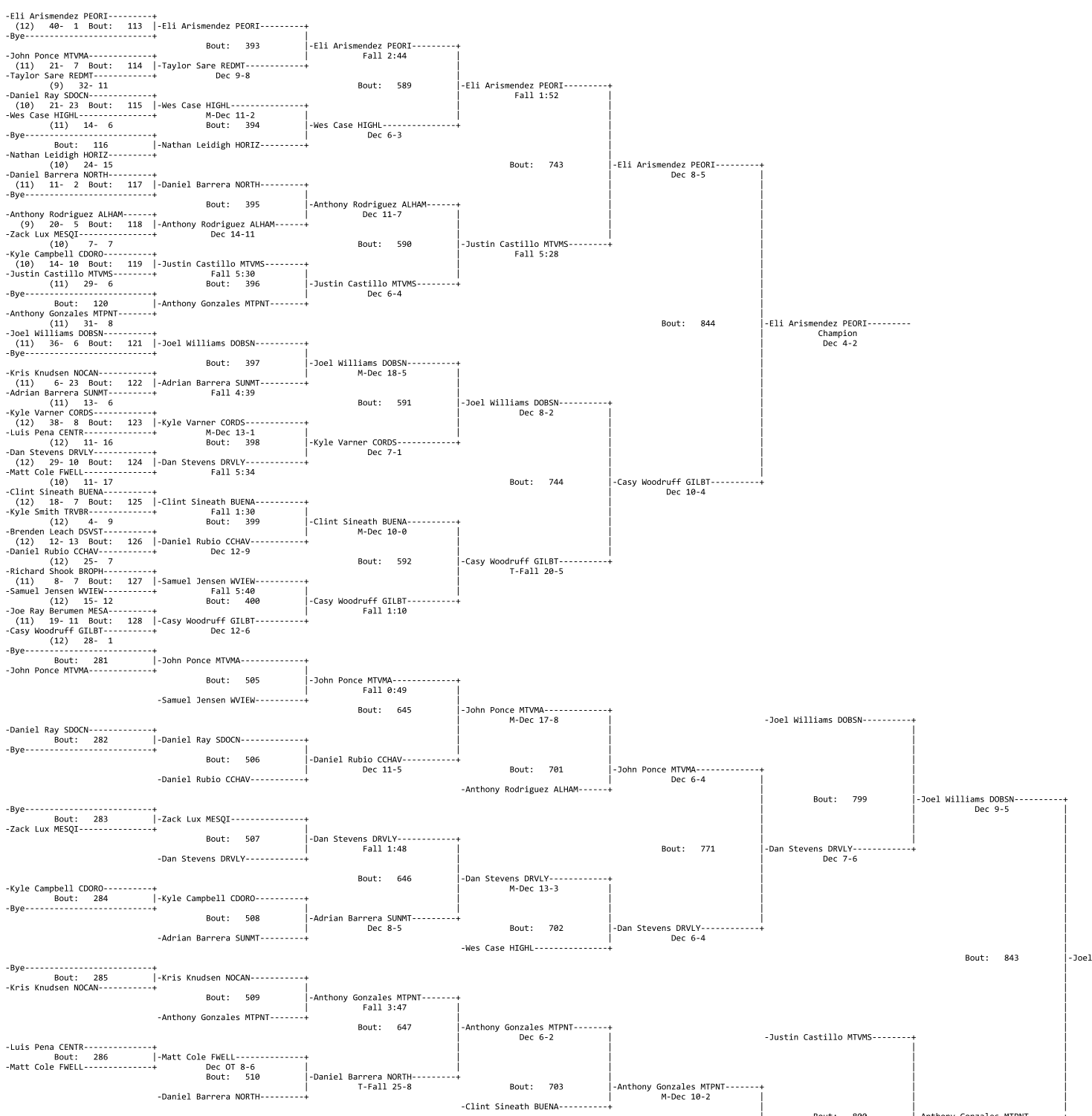

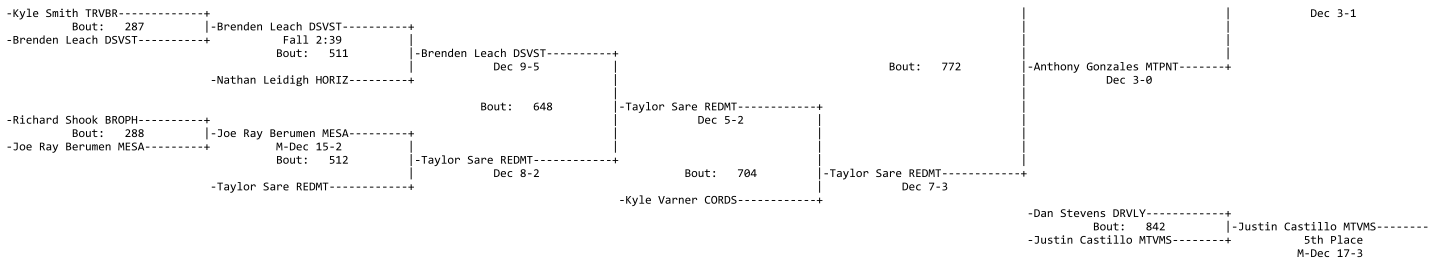

- Place Winners -		- Place Winners -	
1st Eli Arismendez PEORI	(12) 44- 1	5th Justin Castillo MTVMS	(11) 33- 8
2nd Casey Woodruff GIBT	(12) 32- 2	6th Dan Stevens DRVLY	(12) 34- 13
3rd Joel Williams DOBSN	(11) 48- 7		
4th Anthony Gonzales MTPNT	(11) 36- 10		

Weight: 152

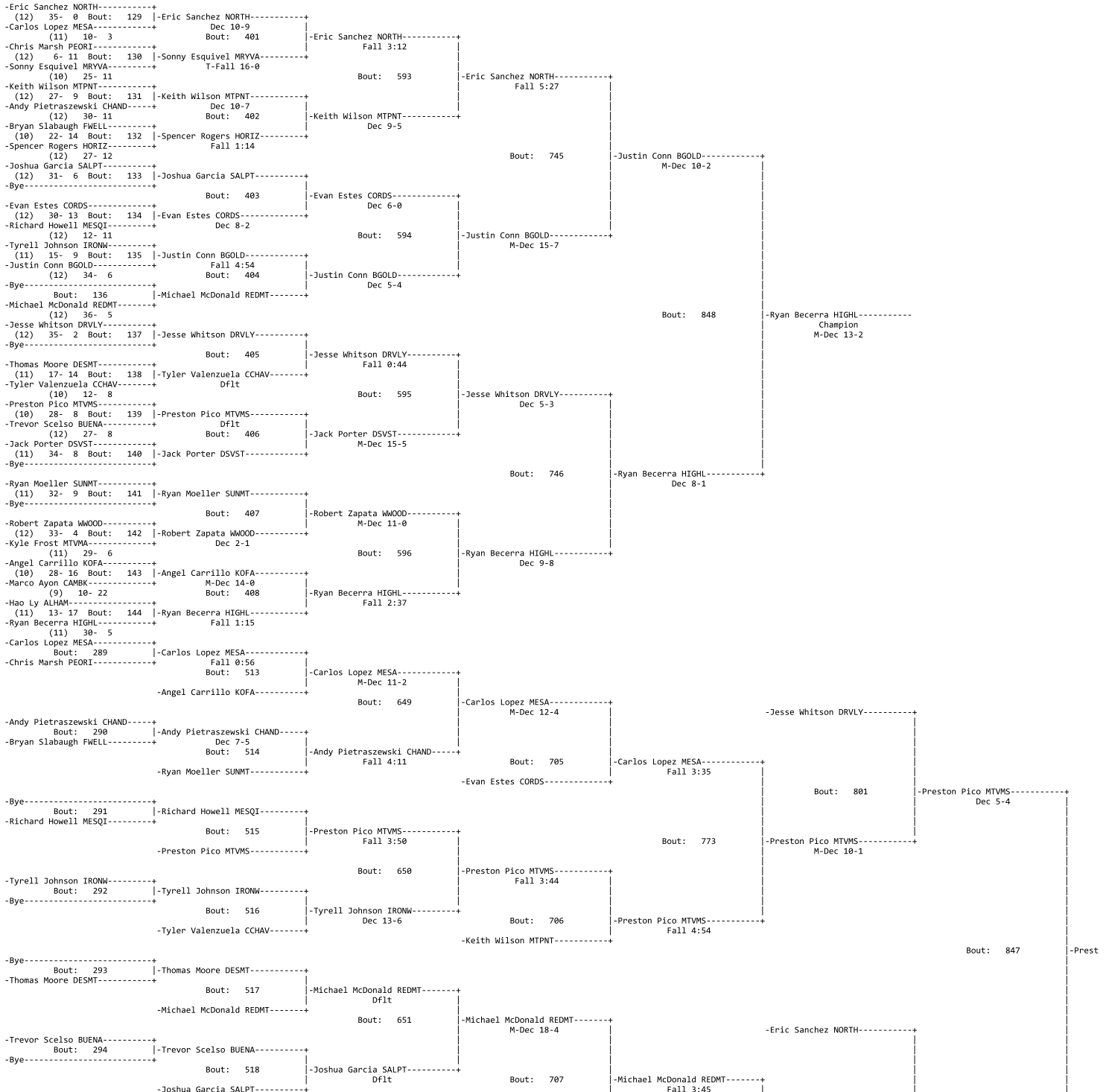

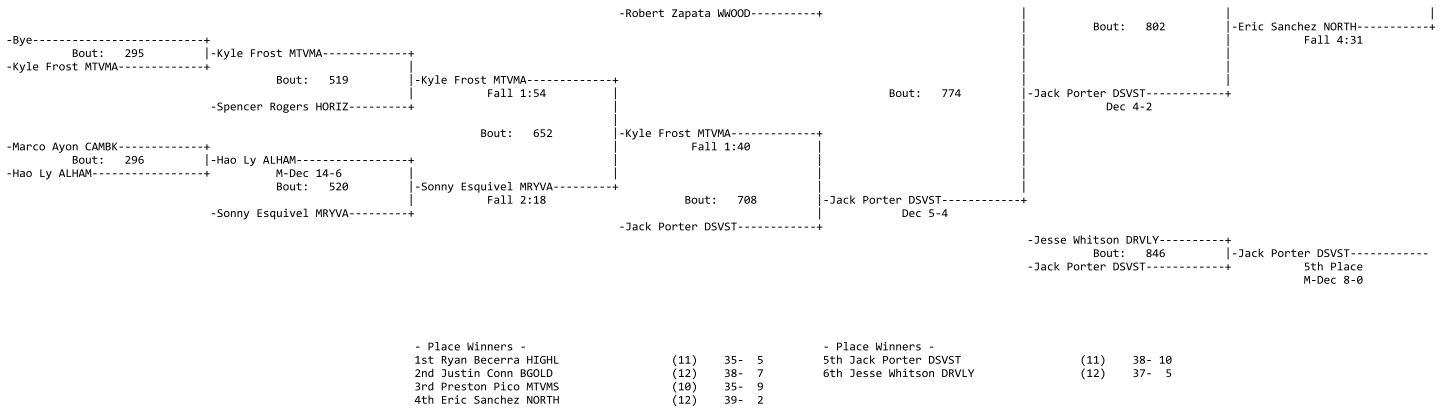

Weight: 160

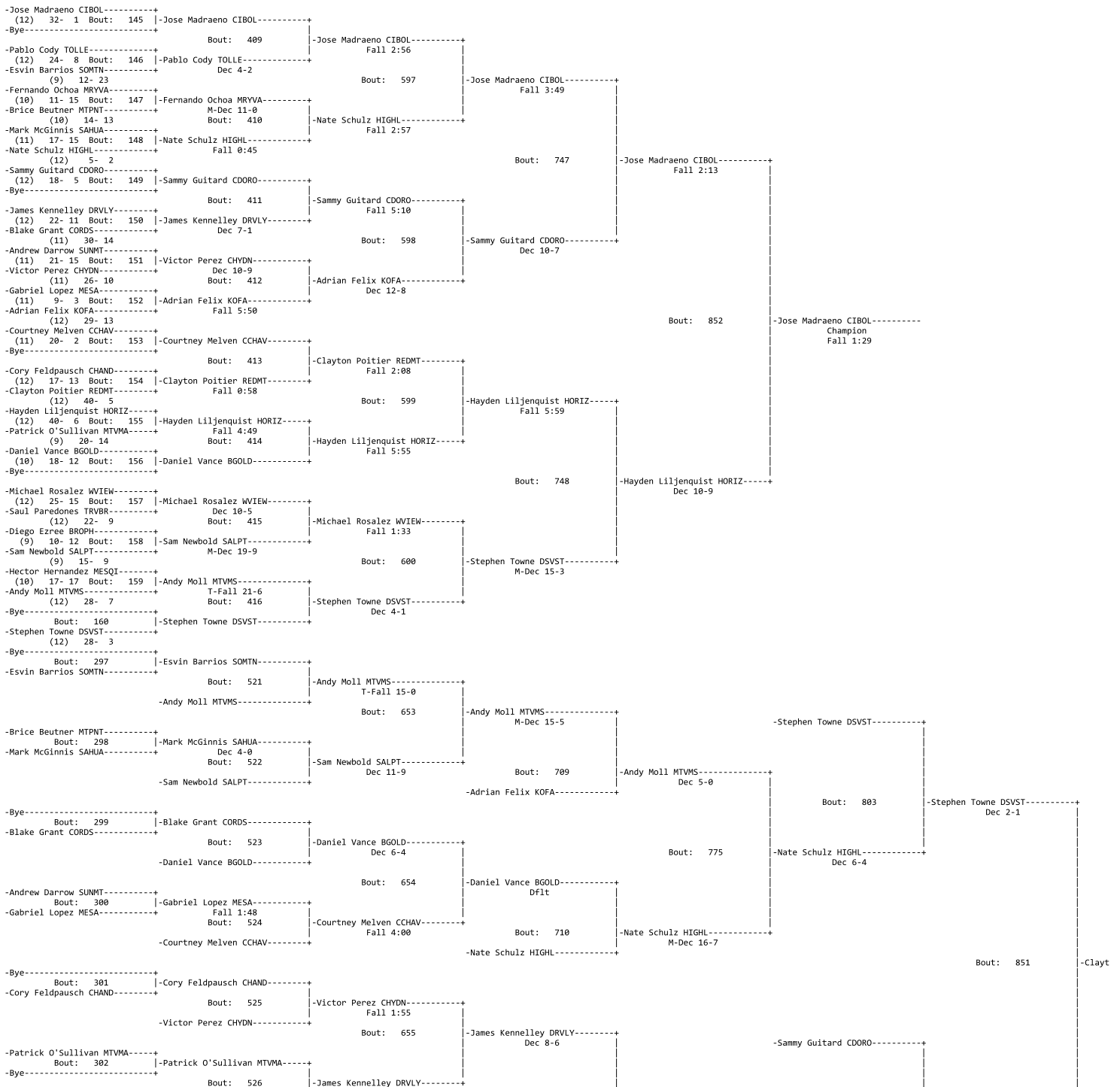

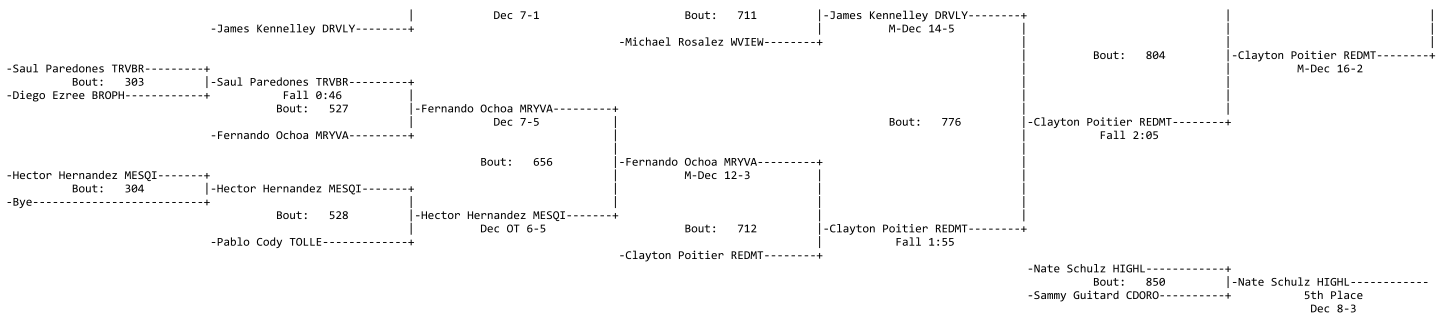

- Place Winners -		- Place Winners -	
1st Jose Madraeno CIBOL	(12) 36- 1	5th Nate Schulz HIGHL	(12) 10- 4
2nd Hayden Liljenquist HORIZ	(12) 44- 7	6th Sammy Guitard CDORO	(12) 20- 8
3rd Clayton Poitier REDMT	(12) 46- 6		
4th Stephen Towne DSVST	(12) 31- 5		

Weight: 171

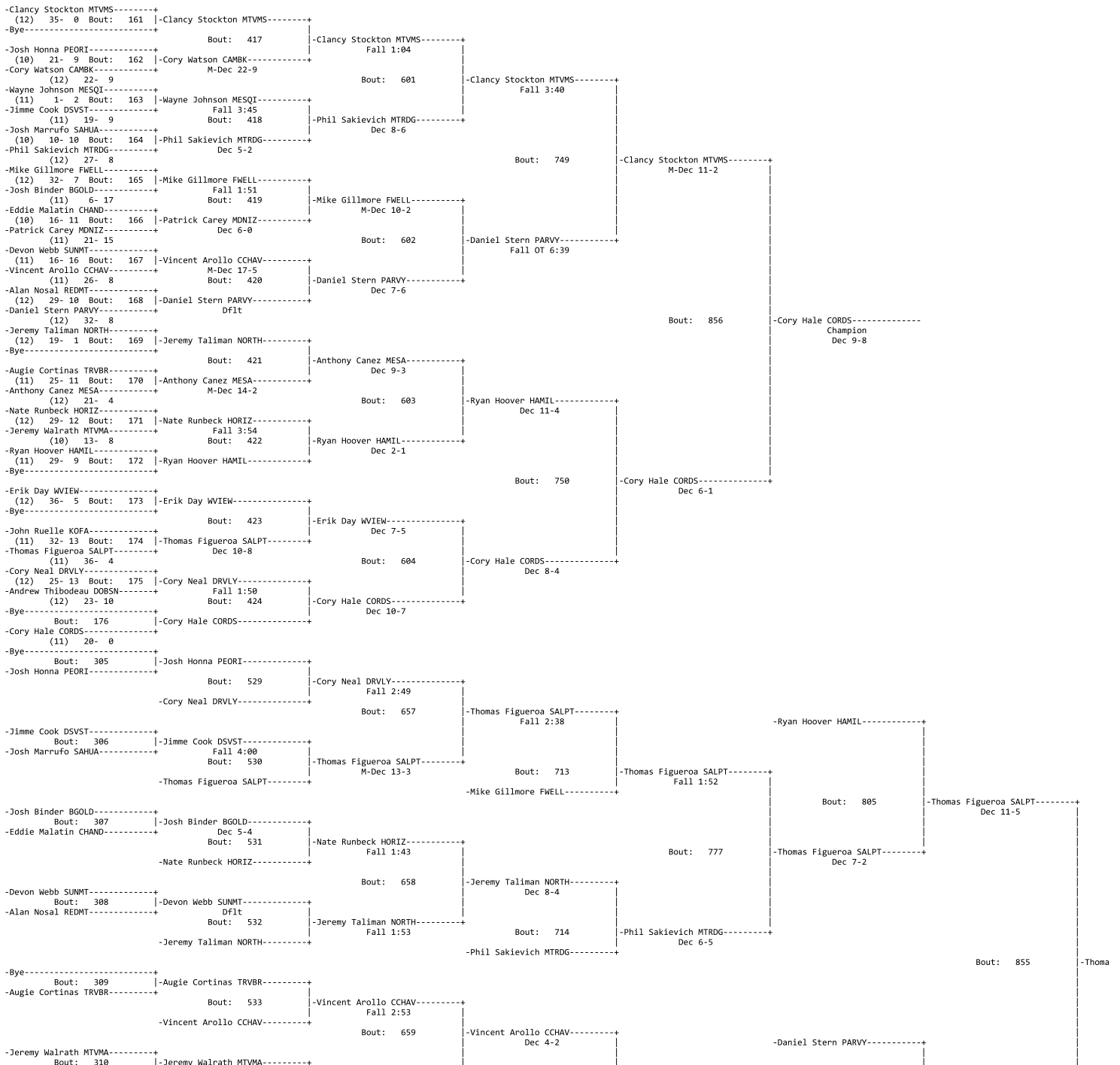

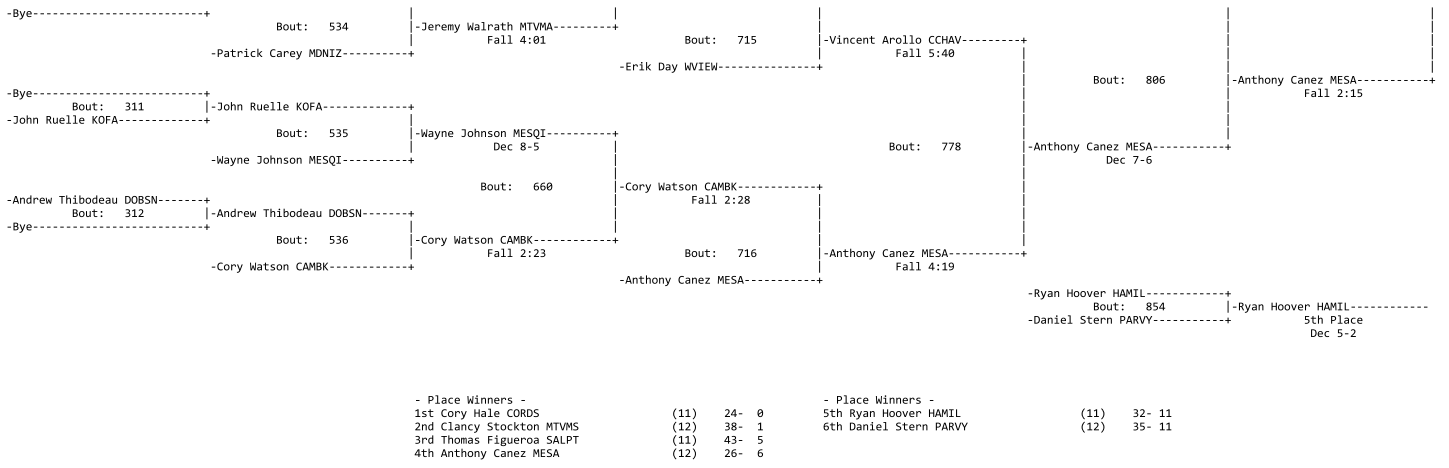

Weight: 189

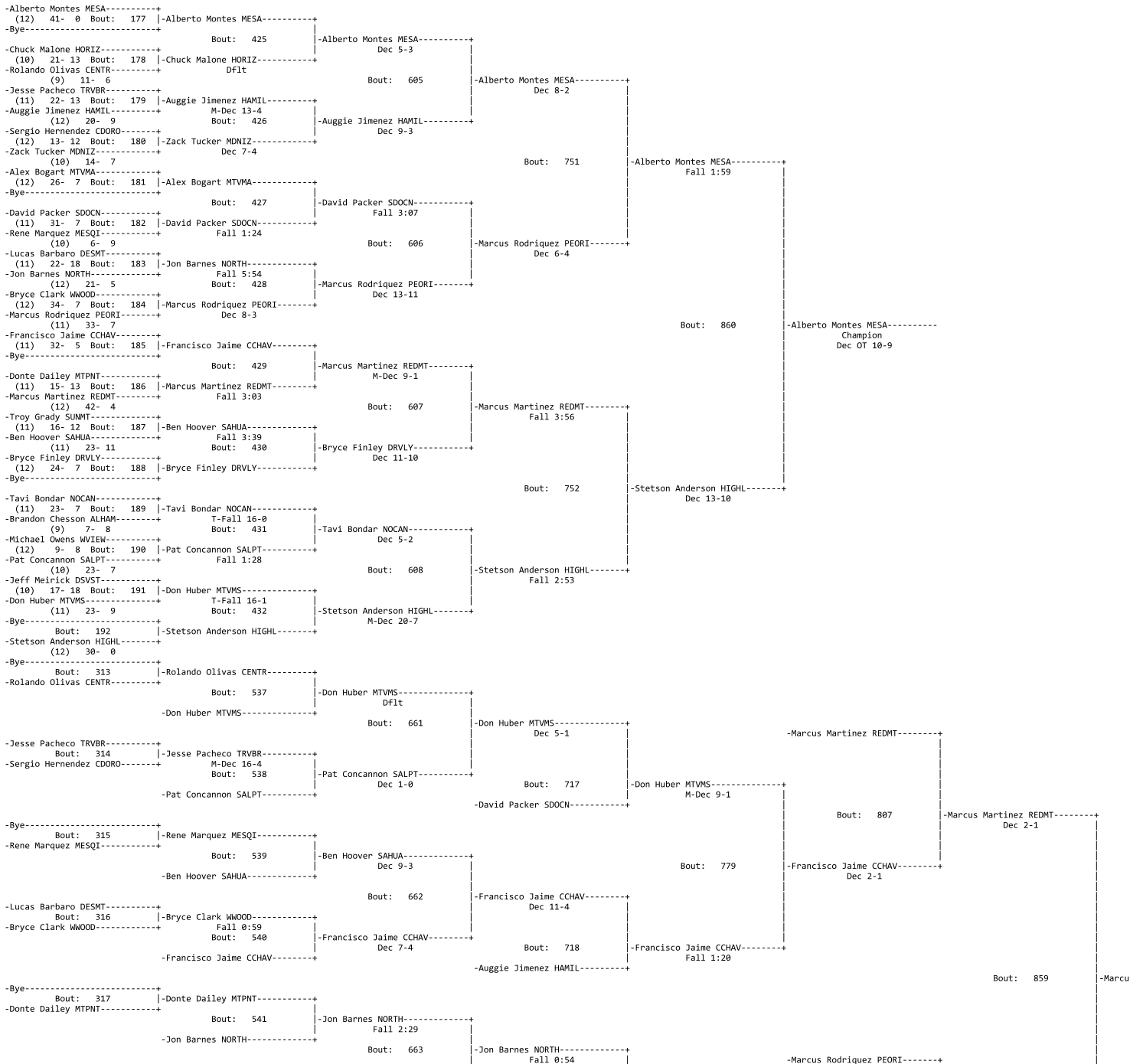

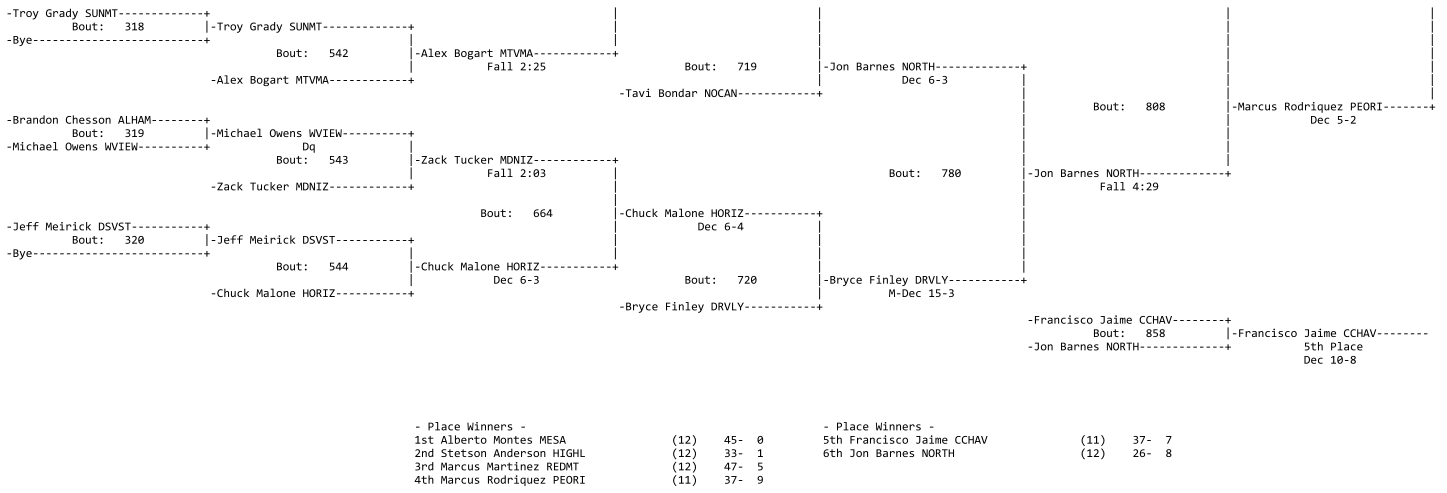

Weight: 215

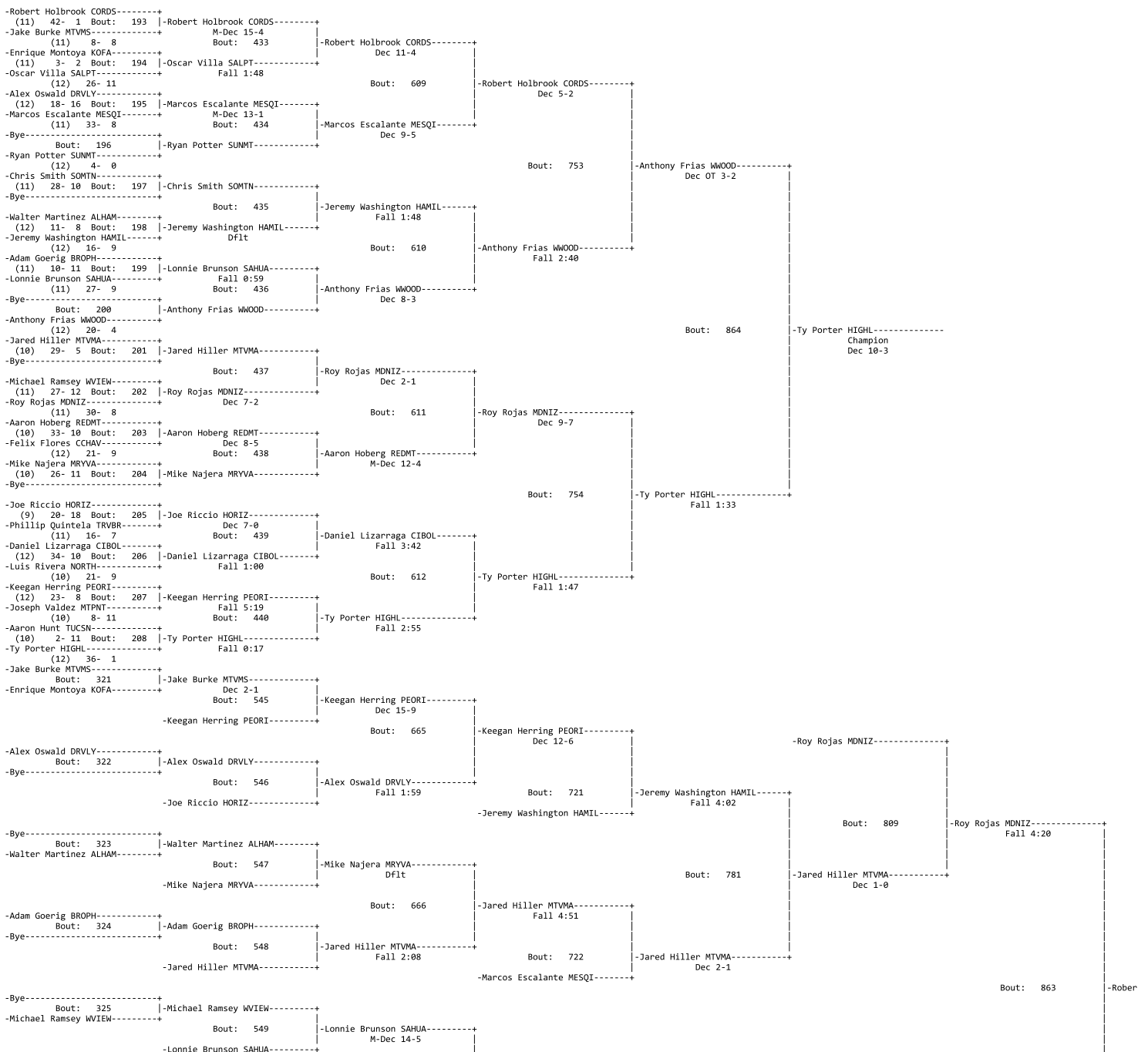

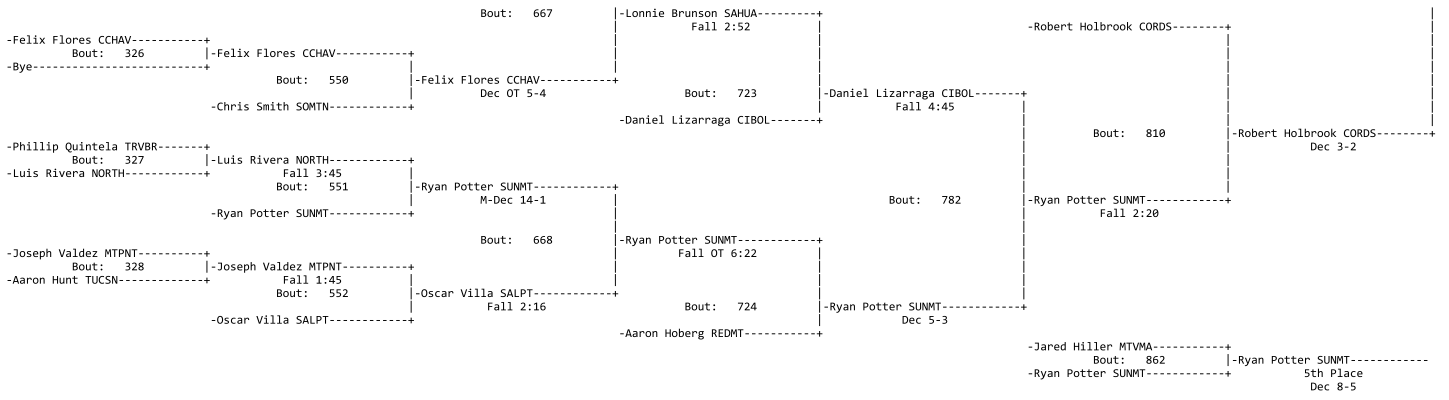

- Place Winners -
 1st Ty Porter HIGHL
 2nd Anthony Frias WWOOD
 3rd Robert Holbrook CORDS
 4th Roy Rojas MDNIZ

(12) 41- 1
 (12) 23- 5
 (11) 47- 2
 (11) 34- 10

- Place Winners -
 5th Ryan Potter SUNMT
 6th Jared Hiller MTVMA

(12) 9- 2
 (10) 33- 8

Weight: 275

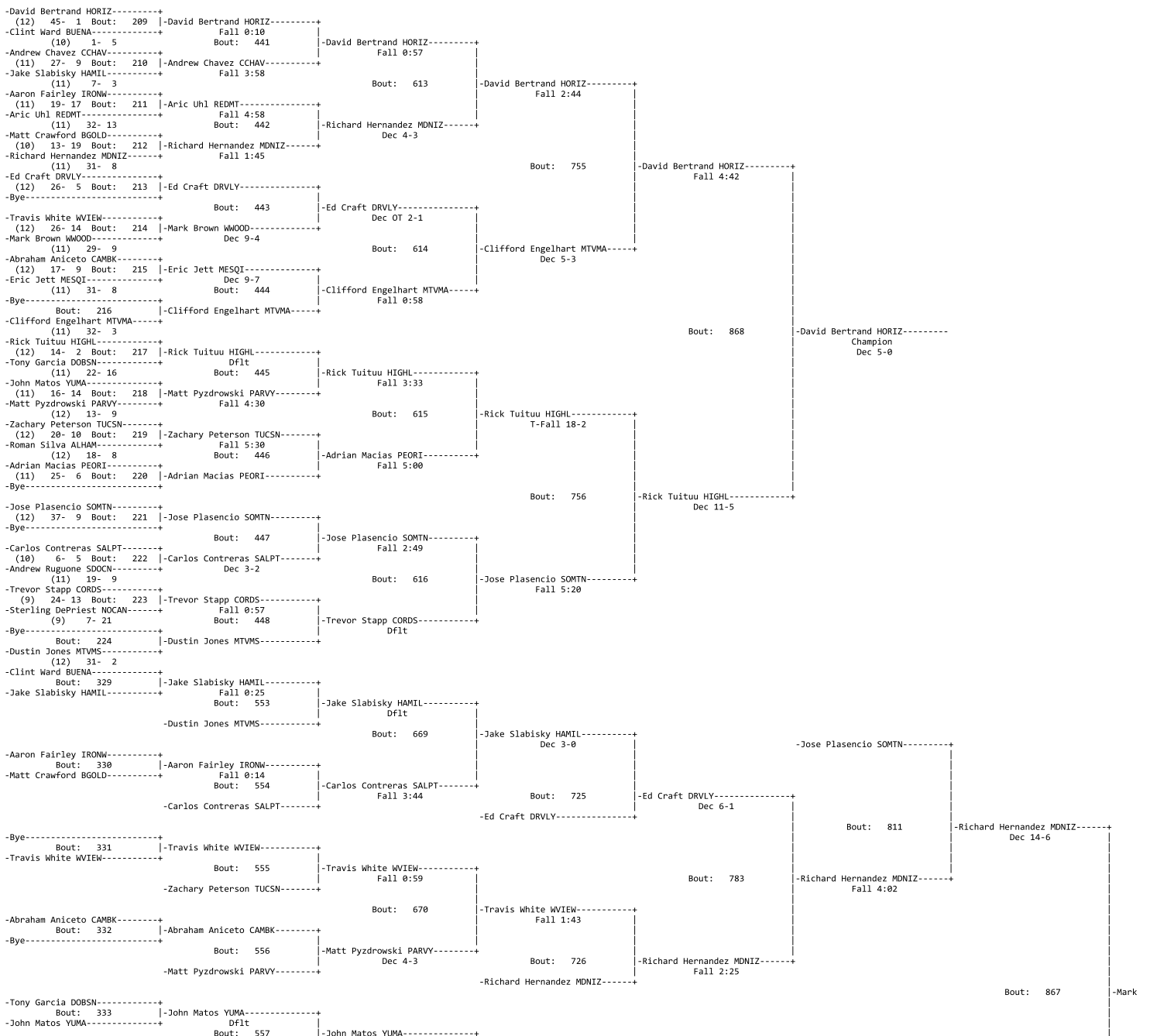

Brackets

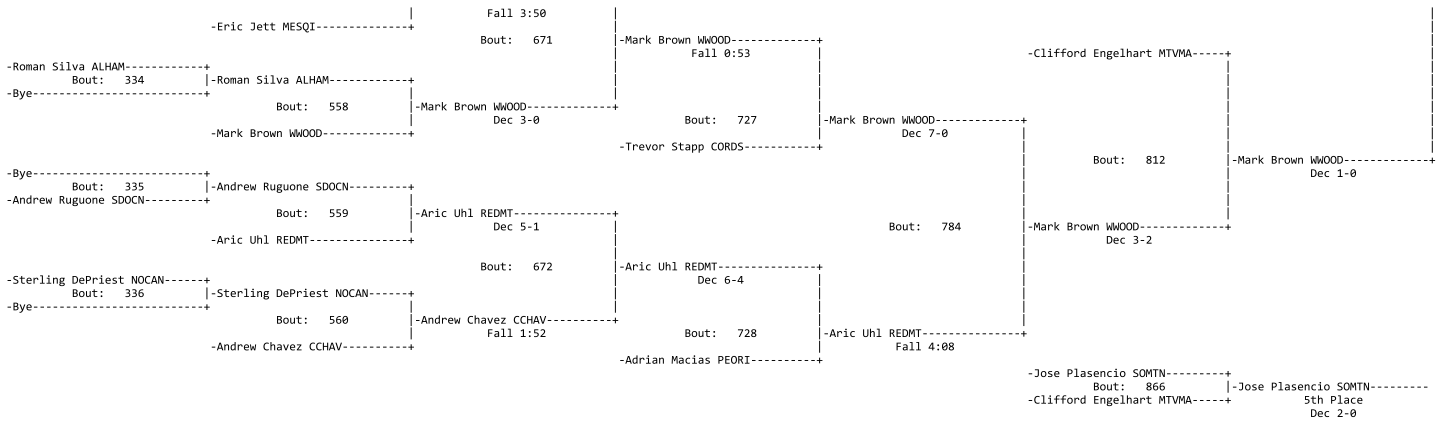

- Place Winners -
 1st David Bertrand HORIZ (12) 50- 1
 2nd Rick Tuituu HIGHL (12) 18- 3
 3rd Mark Brown WWOOD (11) 36- 10
 4th Richard Hernandez MDNIZ (11) 36- 10

- Place Winners -
 5th Jose Plasencio SOMTN (12) 40- 11
 6th Clifford Engelhart MTVMA (11) 34- 6

[Preferred Educational Software](#)

9585 Woodgate Lane
 Byron IL 61010
 Phone: (888) 959-2016
 e-mail: cotterk@pes-sports.com

(c) 2001 - All rights reserved